

# Compendium of Sanitation Systems and Technologies

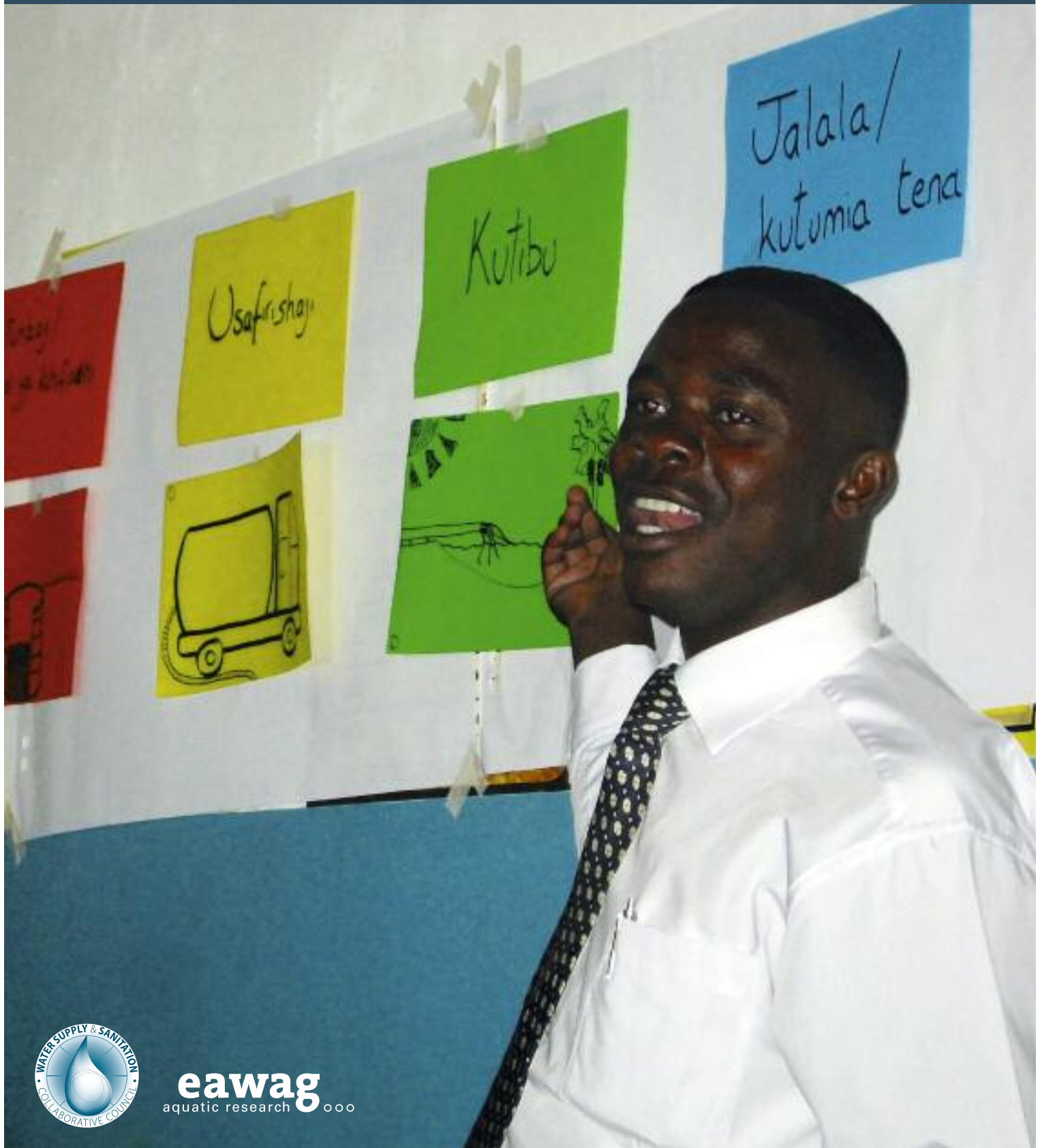

---

# **Compendium of Sanitation Systems and Technologies**

---

**Elizabeth Tilley, Christoph Lüthi, Antoine Morel,  
Chris Zurbrügg and Roland Schertenleib.**

Our special thanks go to:  
the NETSSAF Consortium, the GTZ ecosan programme  
and the Sustainable Sanitation Alliance (SuSanA).

We would like to thank the following individuals  
for their contributions and comments:  
Chris Buckley, Pierre-Henri Dodane, Barbara Evans, Doulaye Koné,  
Elisabeth Kvarnström, Duncan Mara, Peter Morgan, Arne Panesar,  
Eddy Perez, Elias Rosales, Arno Rosemarin, Sören Rud, Darren Saywell,  
Margaret Scott, Steven Sugden, Kevin Tayler, Kai Udert,  
Carolien van der Voorden, Yvonne Voegeli, Anita Wittmer.

We would like to acknowledge support from:  
the Swiss National Centre of Competence in Research (NCCR)  
North-South: Research Partnerships for Mitigating Syndromes of  
Global Change, co-funded by the Swiss National Science Foundation (SNSF)  
and the Swiss Agency for Development and Cooperation (SDC).



**Roland Schertenleib**  
Eawag/Sandec



**Jon Lane**  
WSSCC

Investing in sanitation and hygiene is not only about saving human lives and dignity; it is the foundation for investing in human development, especially in poor urban and peri-urban areas. However, one of the main bottlenecks encountered the world over, is the limited knowledge and awareness about more appropriate and sustainable systems and technologies that keep project costs affordable and acceptable.

Abundant information exists about sanitation technologies but it is scattered throughout dozens of books, reports, proceedings and journals; this Compendium aims to pull the main information together in one volume. Another aim of the Compendium is to promote a systems approach; sanitation devices and technologies should always be considered as parts of an entire system.

In 2005, Sandec and the WSSCC published Provisional Guidelines for Household-centred Environmental Sanitation (HCES), a new planning approach for implementing the Bellagio Principles on Sustainable Sanitation in Urban Environmental Sanitation. The HCES approach emphasizes the participation of all stakeholders – beginning at the household/neighbourhood – in planning and implementing sanitation systems. By ordering and structuring a huge range of information on fully and partly tested technologies into one concise document, this Compendium is an important tool for stakeholders to make well informed decisions during the planning process.

Although this source book is primarily addressed to engineers and planners dealing with infrastructure delivery, the technology sheets also allow non-experts to understand the main advantages and limitations of different technologies and the appropriateness of different system configurations. It is our hope that this Compendium will allow all stakeholders to be involved in selecting improved sanitation technologies and to help promote people-centred solutions to real sanitation problems.

This is the first edition of the Compendium and we are looking forward to receiving your feedback – experiences and suggestions for a next edition are very welcome!

*Roland Schertenleib Jon Lane*

---

## Table of Contents

---

### Introduction: The Aim and Use of this Compendium

Background	7
Target User of the Compendium	7
Objective of the Compendium	7
Structure of the Compendium	7

### Part 1: **Systems Templates**

#### **General Informations about Sanitation Systems**

Products	11
Functional Groups	13
Technologies	13
Using the System Templates	14

#### **Description of the System Templates**

System 1: Single Pit System	16
System 2: Waterless System with Alternating Pits	18
System 3: Pour Flush System with Twin Pits	20
System 4: Waterless System with Urine Diversion	22
System 5: Blackwater Treatment System with Infiltration	24
System 6: Blackwater Treatment System with Sewerage	26
System 7: (Semi-) Centralized Treatment System	28
System 8: Sewerage System with Urine Diversion	30

### Part 2: **Functional Groups with Technology Information Sheets**

Reading the Technology Information Sheets	33
---	----

#### **Functional Group U: User Interface** **35**

U1: Dry Toilet	37
U2: Urine Diverting Dry Toilet (UDDT)	39
U3: Urinal	41
U4: Pour Flush Toilet	43
U5: Cistern Flush Toilet	45
U6: Urine Diverting Flush Toilet (UDFT)	47

#### **Functional Group S: Collection and Storage/Treatment** **49**

S1: Urine Storage Tank/Container	51
S2: Single Pit	53
S3: Single Ventilated Improved Pit (VIP)	55
S4: Double Ventilation Improved Pit (VIP)	57
S5: Fossa Alterna	59
S6: Twin Pits for Pour Flush	61
S7: Dehydration Vaults	63
S8: Composting Chamber	65
S9: Septic Tank	67

S10: Anaerobic Baffled Reactor (ABR)	69
S11: Anaerobic Filter	71
S12: Anaerobic Biogas Reactor	73
<b>Functional Group C: Conveyance</b>	<b>75</b>
C1: Jerrycan/tank	77
C2: Human-Powered Emptying and Transport	79
C3: Motorized Emptying and Transport	81
C4: Simplified Sewers	83
C5: Solids-Free Sewer	85
C6: Conventional Gravity Sewer	87
C7: Transfer Station (Underground Holding Tank)	89
C8: Sewer Discharge Station (SDS)	91
<b>Functional Group T: (Semi-) Centralized Treatment</b>	<b>93</b>
T1: Anaerobic Baffled Reactor (ABR)	95
T2: Anaerobic Filter	97
T3: Waste Stabilization Ponds (WSP)	99
T4: Aerated Pond	101
T5: Free-Water Surface Constructed Wetland	103
T6: Horizontal Subsurface Flow Constructed Wetland	105
T7: Vertical Flow Constructed Wetland	107
T8: Trickling Filter	109
T9: Upflow Anaerobic Sludge Blanket Reactor (UASB)	111
T10: Activated Sludge	113
T11: Sedimentation/Thickening Ponds	115
T12: Unplanted Drying Beds	117
T13: Planted Drying Beds	119
T14: Co-Composting	121
T15: Anaerobic Biogas Reactor	123
<b>Use and/or Disposal</b>	<b>125</b>
D1: Fill and Cover/ Arborloo	127
D2: Application of Urine	129
D3: Application of Dehydrated Faeces	131
D4: Application of Compost/Eco-Humus	133
D5: Irrigation	135
D6: Soak Pit	137
D7: Leach Field	139
D8: Aquaculture Ponds	141
D9: Floating Plant (Macrophyte) Pond	143
D10: Water Disposal/Groundwater (GW) Recharge	145
D11: Land Application of Sludge	147
D12: Surface Disposal	149
<b>Glossary</b>	<b>151</b>

## Background

This document was developed in the context of the Household Centered Environmental Sanitation (HCES) planning approach shown in Figure 1. The HCES approach is a 10-step multi-sector and multi-actor participatory planning process. The guidelines for implementing HCES are available from [www.sandec.ch](http://www.sandec.ch).

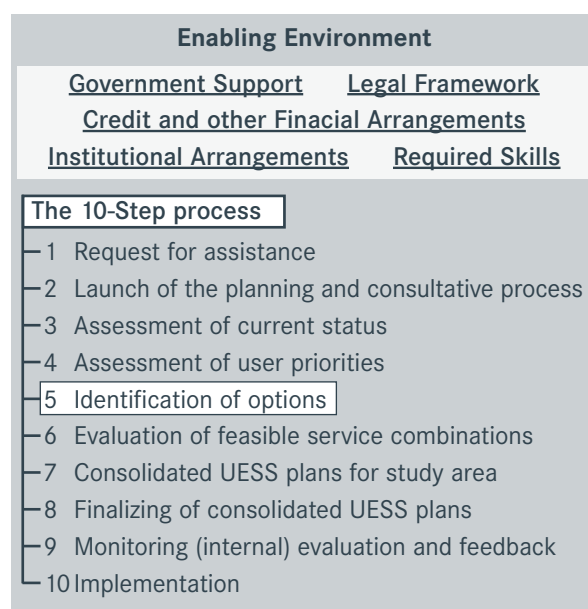

Figure 1. The 10-step process in the HCES planning approach (EAWAG, 2005)

The first four steps of the HCES planning approach define the project-specific social, cultural, economic, health and environmental priorities which will influence technology selection and the system design. The goal of steps five (5) and six (6) is to identify specific technological options and to evaluate feasible service combinations. The following steps, seven (7) through ten (10), lead to the formulation or design of a comprehensive Urban Environmental Sanitation Services (UESS) plan.

This Compendium is designed to serve as a resource tool during steps 5 and 6 of the HCES planning approach. It is presupposed that the user of this Compendium has a well-developed awareness of the context and priorities of the community and other stakeholders as the social-cultural elements of sanitation planning are not explicitly addressed in this document.

## Target User of the Compendium

This Compendium is intended to be used by engineers, planners and other professionals who are familiar with sanitation technologies and processes. It is not a training manual or stand-alone resource for people with no experience in sanitation planning.

The user of this document must have an interest in learning more about alternative or novel technologies which may not be part of the common suite employed or taught in the local context. The approach and information presented herein is meant to broaden the spectrum of innovative and appropriate technologies considered for sanitation planning.

## Objective of the Compendium

The objective the Compendium is threefold:

1. Expose the Compendium user to a broad range of sanitation systems and innovative technologies;
2. Help the Compendium user understand and work with the system concept, i.e. the process of building a complete system, by iteratively choosing and linking appropriate technologies;
3. Describe and fairly present the technology-specific advantages and disadvantages.

## Structure of the Compendium

The Compendium is divided into 2 Parts; (1) the **System Templates** and a description about how to use them; and (2) the **Technology Information Sheets**.

It is recommended that the Compendium user reviews Part 1: Sanitation Systems to become familiar with the terminology and structure of the System Templates and their components. The user can then familiarize themselves with the technologies of interest in Part 2: Technology Information Sheets. The user can move between the System Templates and the Technology Information Sheets (they are cross-referenced) until he/she has identified some systems and/or technologies that could be appropriate for further investigation. Eventually, the user should be able to develop one, or several system configurations that can be presented to the community. The Compendium can then be used, following the community's suggestions, to re-evaluate and redesign the system accordingly.



This Compendium defines sanitation as a multi-step process in which wastes are managed from the point of generation to the point of use or ultimate disposal. A sanitation system is comprised of **Products** (wastes) which travel through **Functional Groups** which contain **Technologies** which can be selected according to the context. A sanitation system also includes the management, operation and maintenance (O&M) required to ensure that the system functions safely and sustainably. **By selecting a Technology for each Product from each applicable Functional Group, one can design a logical sanitation system.**

The purpose of this Part is to clearly explain the System Templates by describing what they consist of, what qualities they have and how they are to be used.

This Compendium describes eight (8) different System Templates.

System 1: Single Pit System

System 2: Waterless System with Alternating Pits

System 3: Pour Flush System with Twin Pits

System 4: Waterless System with Urine Diversion

System 5: Blackwater Treatment System with Infiltration

System 6: Blackwater Treatment System with Sewerage

System 7: (Semi-) Centralized Treatment System

System 8: Sewerage System with Urine Diversion

A System Template defines a suite of compatible Technology combinations from which a system can be designed. Each System Template is distinct in terms of the characteristics and the number of **Products** generated and processed. The System Templates present logical combinations of Technologies, but the planner must not lose a rational, engineering perspective. It must also be noted that although this Compendium is thorough, it is not an exhaustive list of Technologies and/or associated systems.

Although the System Templates are predefined, the Compendium user must select the appropriate Technology from the options presented. The choice is context specific and should be made based on the local environment (temperature, rainfall, etc.), culture (sitters, squatters, washers, wipers, etc.) and resources (human and material).

System templates 1 to 8 range from simple (with few Technology choices and Products) to complex (with multiple Technology choices and Products).

The first section of this chapter defines the parts of the System Templates. Products, Functional Groups, and Technologies are explained.

The second part of this chapter explains how the System Templates can be read, understood, and used to build a functional Sanitation System.

The final section of this Chapter presents a description of how the system works, what are the main considerations, and what type of applications that system is appropriate for.





## Products

**Products** are materials that are also called ‘wastes’ or ‘resources’. Some Products are generated directly by humans (e.g. urine and faeces), others are required in the functioning of Technologies (e.g. flush water to move excreta through sewers) and some are generated as a function or storage or treatment (e.g. faecal sludge).

For the design of a robust sanitation system, it is necessary to define all of the Products that are flowing into (Inputs) and out (Outputs) of each of the sanitation Technologies in the system. The Products referenced within this text are described below.

**Urine** is the liquid waste produced by the body to rid itself of urea and other waste Products. In this context, the urine Product refers to pure urine that is not mixed with faeces or water. Depending on diet, human urine collected during one year (ca. 500 L) contains 2–4 kg nitrogen. With the exception of some rare cases, urine is sterile when it leaves the body.

**Faeces** refers to (semi-solid) excrement without urine or water. Each person produces approximately 50 L per year of faecal matter. Of the total nutrients excreted, faeces contain about 10% N, 30% P, 12% K and have  $10^7$ – $10^9$  faecal coliforms / 100 mL.

**Anal cleansing water** is water collected after it has been used to cleanse oneself after defecating and/or urinating. It is only the water generated by the user for anal cleansing and does not include dry materials. The volume of water collected during anal cleansing ranges from 0.5 L to 3 L per cleaning.

**Stormwater** is the general term for the rainfall runoff collected from roofs, roads and other surfaces before flowing towards low-lying land. It is the portion of rainfall that does not infiltrate into the soil.

**Greywater** is the total volume of water generated from washing food, clothes and dishware as well as from bathing. It may contain traces of excreta and therefore will also contain pathogens and excreta. Greywater accounts for approximately 60% of the

wastewater produced in households with flush toilets. It contains few pathogens and its flow of nitrogen is only 10–20% of that in blackwater.

**Flushwater** is the water that is used to transport excreta from the User Interface to the next technology. Freshwater, rainwater, recycled greywater, or any combination of the three can be used as a Flushwater source.

**Organics** refers here to biodegradable organic material that could also be called biomass or green organic waste. Although the other Products in this Compendium contain organics, this term refers to undigested plant material. Organics must be added to some technologies in order for them to function properly (e.g. composting chambers). Organic degradable material can include but is not limited to leaves, grass and market waste.

**Dry Cleansing Materials** may be paper, corncobs, rags, stones and/or other dry materials that are used for anal cleansing (instead of water). Depending on the system, the dry cleansing materials may be collected and disposed of separately. Although extremely important, we have not included a separate Product name for menstrual hygiene products like sanitary napkins and tampons. In general (though not always), they should be treated along with the Dry Cleansing Materials that are described here.

**Blackwater** is the mixture of urine, faeces and flushwater along with anal cleansing water (if anal cleansing is practiced) and/or dry cleansing material (e.g. toilet paper). Blackwater has all of the pathogens of faeces and all of the nutrients of urine, but diluted in flushwater.

**Faecal Sludge** is the general term for the raw (or partially digested) slurry or solid that results from the storage of blackwater or excreta. The composition of faecal sludge varies significantly depending on the location, the water content, and the storage. For example, ammonium ( $\text{NH}_4\text{-N}$ ) can range from 300–3000 mg/L while Helminth eggs can reach up to 60,000 eggs/L. The composition will determine the type of treatment that is possible and the end-use possibilities.

**Treated Sludge** is the general term for partially digested or fully stabilized faecal sludge. The US Environmental Protection Agency has strict criteria to differentiate between degrees of treatment and consequently, how those different types of sludges can be used. 'Treated Sludge' is used in the System Templates and in the Technology Information Sheets as a general term to indicate that the sludge has undergone some level of treatment, although it should not be assumed that 'treated sludge' is fully treated or that it is automatically safe. It is meant to indicate that the sludge has undergone some degree of treatment and is no longer raw. It is the responsibility of the user to inquire about the composition, quality and therefore safety of the local sludge.

**Excreta** consists of urine and faeces that is not mixed with any flushing water. Excreta is small in volume, but concentrated in nutrients and pathogens. Depending on the quality of the faeces it is solid, soft or runny.

**Brownwater** consists of faeces and flushwater (although in actual practice there is always some urine, as only 70–85% of the urine is diverted). Brownwater is generated by urine-diverting flush toilets and therefore, the volume depends on the volume of the flushwater used. The pathogen and nutrient load of faeces is not reduced, only diluted by the flushwater.

**Dried faeces** are faeces that have been dehydrated at high temperatures (and high pH) until they become a dry, sanitized powder. Very little degradation occurs during dehydration and this means that the dried faeces are still rich in organic material. Faeces will reduce in volume by around 75%. There is a small risk that some organisms can be reactivated in the right environments.

**Stored urine** is urine that has been hydrolyzed naturally over time, i.e. the urea has been converted by enzymes into carbon dioxide and ammonia. Stored urine has a pH of approximately 9. After 6 months of storage, the risk of pathogen transmission is reduced considerably.

**Effluent** is the general term for liquid that has undergone some level of treatment and/or separation from solids. It originates at either a Collection and Storage/Treatment or a (Semi-) Centralized Treatment Technology. Depending on the type of treatment, the effluent may be completely sanitized or may require further treatment before it can be used or disposed of.

**Compost/EcoHumus** is the earth-like, brown/black material that is the result of decomposed organic matter. Generally Compost/EcoHumus has been hygienized sufficiently that it can be used safely in agriculture. Because of leaching, some of the nutrients are lost, but the material is still rich in nutrients and organic matter.

**Biogas** is the common name for the mixture of gases released from anaerobic digestion. Typically biogas is comprised of methane (50–75%), carbon dioxide (25–50%) and varying quantities of nitrogen, hydrogen sulphide, water and other components.

**Forage** refers to aquatic or other plants that grow in planted drying beds or constructed wetlands and may be harvested for feeding livestock.

This Compendium is primarily concerned with systems and Technologies directly related to excreta and does not address the specifics of greywater or stormwater management but shows when they can be co-treated with excreta. So although greywater and stormwater are shown as Products in the System Templates, the related Technologies are not described in detail. For a more comprehensive summary of dedicated greywater Technologies refer to the following resource:

— Morel A. and Diener S. (2006). *Greywater Management in Low and Middle-Income Countries, Review of different treatment systems for households or neighbourhoods*. Swiss Federal Institute of Aquatic Science and Technology (Eawag). Duebendorf, Switzerland.  
[Available free for download: www.eawag.ch](http://www.eawag.ch)

## Functional Groups

A **Functional Group** is a grouping of technologies which perform a similar function. There are five (5) different **Functional Groups** from which the technologies used to build a system are chosen. It is not necessary for a Product to pass through a technology from each Functional Group; however, the ordering of the Functional Groups should usually be maintained regardless of how many of them are included within the sanitation system. Also, each Functional Group has a distinctive colour; technologies within a given Functional Group share the same colour code so that they are easily identifiable.

The five (5) Functional Groups are:

**U** **User Interface** (Technologies U1–U6): Red

**S** **Collection and Storage/Treatment**  
(Technologies S1–S12): Orange

**C** **Conveyance** (Technologies C1–C8): Yellow

**T** **(Semi-) Centralized Treatment**  
(Technologies T1–T15): Green

**D** **Use and/or Disposal** (Technologies D1–D12): Blue

Each technology within a given Functional Group is assigned a reference code with a single letter and number; the letter corresponds to the Functional Group (e.g. U for User Interface) and the number, going from lowest to highest, indicates approximately how resource intensive (i.e. economic, material and human) the technology is.

**U** **User Interface (U)** describes the type of toilet, pedestal, pan, or urinal that the user comes in contact with; it is the way that the user accesses the sanitation system. In many cases, the choice of User Interface will depend on the availability of water. Note that greywater and stormwater do not originate at the User Interface, but may be treated along with the Products that originate at the User Interface.

**S** **Collection and Storage/Treatment (S)** describes the ways of collecting, storing, and sometimes treating the Products that are generated at the User Interface.

Treatment that is provided by these Technologies is often a function of storage and usually passive (e.g. no energy inputs). Thus, Products that are ‘treated’ by these Technologies often require subsequent treatment before use or disposal.

**C** **Conveyance (C)** describes the transport of Products from one Functional Group to another. Although Products may need to be transferred in various ways between Functional Groups, the longest, and most important gap is between Collection and Storage/Treatment and (Semi-) Centralized Treatment; thus, for simplicity, conveyance is limited to transporting Products at this point.

**T** **(Semi-) Centralized Treatment (T)** refers to treatment Technologies that are generally appropriate for large user groups (i.e. multiple households). The operation, maintenance, and energy requirements for Technologies within this Functional Group are more intensive. The Technologies are divided into 2 groups: Technologies T1–T10 are primarily for the treatment of blackwater, whereas Technologies T11–T15 are primarily for the treatment of sludge.

**D** **Use and/or Disposal (D)** refers to the methods in which Products are ultimately returned to the environment, as either useful resources or reduced-risk materials. Furthermore, Products can also be cycled back into a system (e.g. the use of treated greywater for flushing).

## Technologies

Technologies are defined as the specific infrastructure, methods, or services that are designed to contain, transform, or transport Products to another Functional Group. There are between 6 and 15 different technologies within each Functional Group. The Technology Information Sheets located in Part 2 provide a detailed description of each technology identified within each System Template.

## Using the System Templates

Each system is a matrix of **Functional Groups** (columns) and **Products** (rows) that are linked together where logical connections exist. Where these logical connections exist, a Technology choice is presented (i.e. for a certain Product (row) intersecting a specific Functional Group (column)).

Each Functional Group is colour-coded and the same colour code is used within a System Template. To facilitate efficient reference between System Templates and Technology Information Sheets the Technologies within each Functional Group adopt the same colour-code. The colour-code for each Functional Group within the System Template is presented below in Figure 2.

Figure 3 is an example from a System Template. A bold colour-coded box indicates a Technology choice within a given Functional Group. This System Template shows how three Products (Faeces, Urine and Flushwater) enter into a User Interface (Pour Flush Toilet and some-

times a Urinal) and emerge as Blackwater. Blackwater then enters the Collection and Storage/Treatment Functional Group and is transformed in the Twin Pits for Pour Flush into Compost/EcoHumus and Effluent. The Compost/EcoHumus is transported (Human Powered) to a final point of use and the Effluent is absorbed by the soil (Disposal/Recharge).

Bold lines with arrows are used to link the most appropriate Functional Groups for a given Product. Thin lines indicate other flow paths which are possible, but not always common or recommended (see Figure 4).

Figure 2. System Template header with colour-code for the Functional Groups

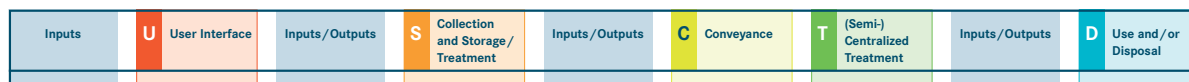
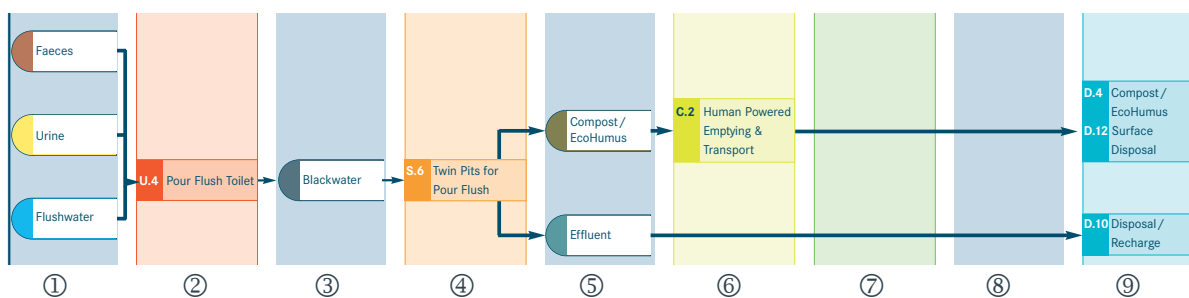

Figure 3. System Template: how Inputs enter into Functional Groups and are transformed



① Three Inputs (Faeces, Urine and Flushwater) enter into ② Functional Group U “User Interface” (Pour Flush Toilet). The Blackwater generated ③ then enters into ④ Functional Group S “Collection and Storage/Treatment” (Twin Pits For Pour Flush Latrine) and is transformed into ⑤ Compost/EcoHumus and Effluent. The Compost/EcoHumus enters into ⑥ Functional Group C “Conveyance” (Human Powered Emptying & Transport) and passes ⑦ Functional Group T “(Semi-) Centralized Treatment” without treatment with no further ⑧ Inputs/Outputs. Compost/EcoHumus is transported directly to the final ⑨ Functional Group D “Use and/or Disposal” (Compost/Eco-Humus, Surface Disposal). The ⑤ Effluent does not enter into ⑥ Functional Group C nor ⑦ Functional Group T (therefore there are ⑧ no Inputs/Outputs) but the Effluent is directly discharged ⑨ in Functional Group D (Disposal/Recharge).

Although the most logical combinations are presented herein, the Technologies and associated links are not exhaustive. The designer should attempt to minimize redundancy, optimize existing infrastructure and make use of local resources.

This methodology should be followed for each area (region or planning zone) under consideration. However, any number of systems can be chosen and it is not necessary that each home, compound, or community within the area choose the same Technologies. Some Technologies may already exist; in that case it is the goal of the planners and engineers to optimize existing infrastructure and reduce redundancy but maintain flexibility with user satisfaction as the primary goal.

**Steps for selecting a System Template:**

- a) Identify the Products that are generated and/or are available locally (e.g. Anal Cleansing Water or Flushwater).
- b) Identify the System Templates that process the defined Products
- c) For each template, select a Technology from each Functional Group where there is a Technology choice presented (bold coloured box); the series of Technologies makes up a System
- d) Compare the systems and iteratively change individual Technologies or use a different System Template based on user priorities, economic constraints, and technical feasibility.

> The eight System Templates are presented and described on the following pages. Each System Template is explained in detail.

Figure 4. Bold lines with arrows are used to link the most appropriate Functional Groups for a given Input or Output. Thin lines indicate other flowstreams which are possible.

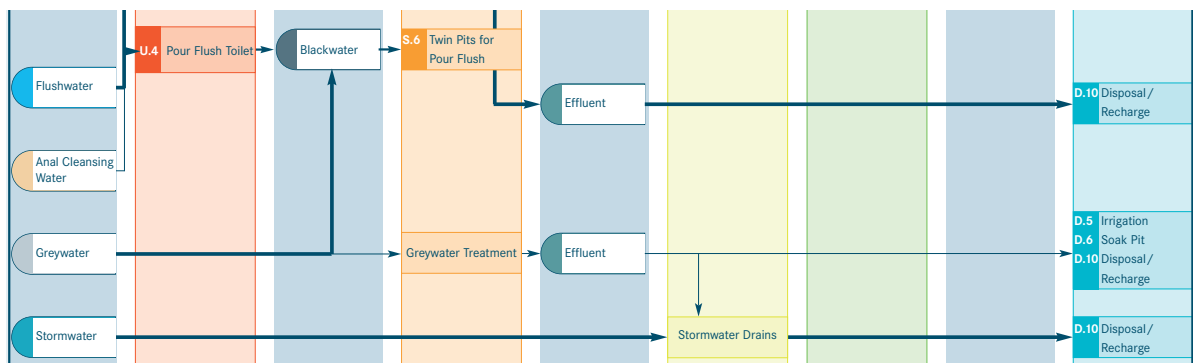

# Sanitation System 1:

# Single Pit System

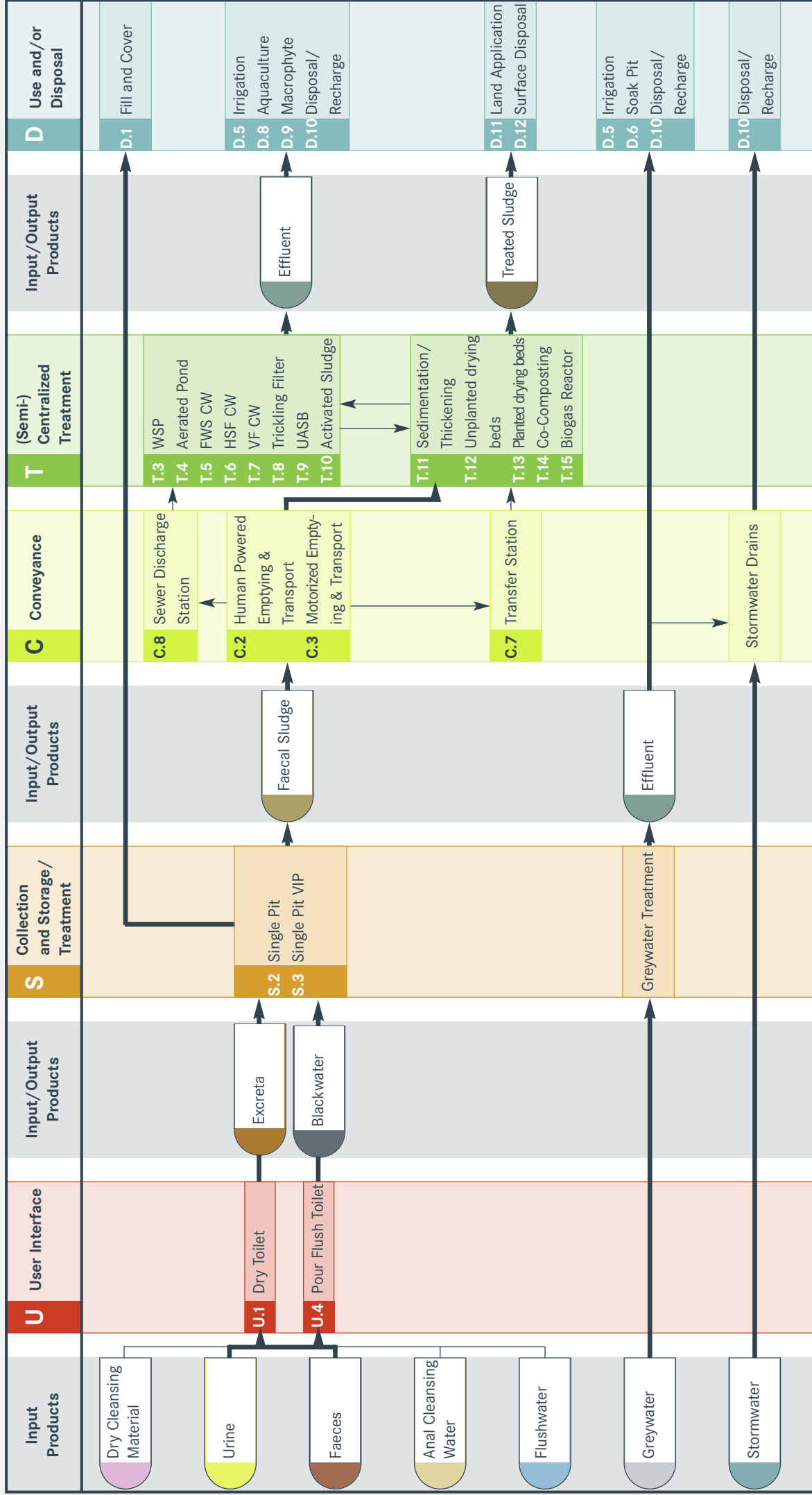

## System 1: Single Pit System

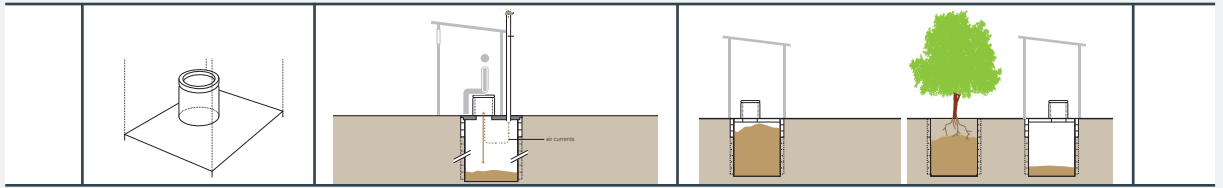

This system is based on the use of a single pit to collect and store the excreta. The system can be used with or without Flushwater depending on the User Interface.

The inputs to the system can include Urine, Faeces, Anal Cleansing Water, Flushwater and Dry Cleansing Materials. The use of Flushwater and/or Anal Cleansing Water will depend on water availability and local habit.

There are two different User Interfaces for this system, which include a Dry Toilet (U1) or a Pour Flush Toilet (U4). The User Interface is directly connected to a Collection and Storage/Treatment Technology: a Single Pit (S2) or a Single Ventilated Improved Pit (VIP) (S3).

When the pit is full there are several options. If there is space, the pit can be filled with soil and planted with a tree, as per the Fill and Cover (D1), and a new pit built. This is generally only possible when the superstructure is mobile. Alternatively, the Faecal Sludge that is generated from the Collection and Storage/Treatment Technology has to be removed and transported for further treatment. The Conveyance Technologies that can be used include Human Powered Emptying and Transport (E&T) for solid sludge (C2) or Motorized E&T for liquid sludge (C3). When the Faecal Sludge is thinner, it must be emptied with a vacuum truck. As the Faecal Sludge is highly pathogenic prior to treatment, human contact and agricultural applications should be avoided. When it is not feasible to empty the full pit, (Semi-) Centralized Treatment can be omitted and the pit can be filled and covered with a suitable material for decommissioning (Fill and Cover: D1). The decommissioned pit can be planted with a fruit or flowering tree since it will thrive in the nutrient rich environment.

Faecal Sludge that is removed can be transported to a dedicated Faecal Sludge treatment facility (Technologies T11 to T15). In the event that the treatment facility is not easily accessible, the Faecal Sludge can be discharged to either a Sewer Discharge Station (C8) or a Transfer Station (C7). From the Sewer Discharge Station, the Faecal Sludge is transported by the sewer and is co-treated with the Blackwater flowing in the sewer network (Technologies T1 to T10). The Faecal Sludge from the Sewer Discharge station is released either directly into the sewer or at timed intervals. If sludge is introduced directly into a

sewer, there must be enough water to adequately dilute and transport the sludge to the treatment facility. From the Transfer Station the Faecal Sludge must be transported to a dedicated Faecal Sludge treatment facility (Technologies T11 to T15) by a motorized vehicle (C3).

All (Semi-) Centralized Treatment Technologies, T1 to T15, produce both Effluent and Faecal Sludge, which require further treatment prior to Use and/or Disposal. Technologies for the Use and/or Disposal of the treated Effluent include Irrigation (D5), Aquaculture (D8), Macrophyte Pond (D9) or Discharge to a water body or Recharge to groundwater (D10).

**Considerations** This system is best suited to rural and peri-urban areas where there is appropriate soil for digging and absorbing the Effluent from the pit. This system should be chosen only where there is either space to continuously dig new pits or when there is an appropriate manner of emptying and disposing of the Faecal Sludge. In dense urban settlements, there may not be sufficient transportation or access to empty or move to another pit. This system is also best suited to areas that are not prone to heavy rains or flooding, which may cause the pits to overflow. Some Greywater in the pit may help degradation, but excessive additions of Greywater may shorten the life of the pit.

Although different types of pits are common in most parts of the world, a well designed pit-based system with appropriate transport, treatment and use or disposal, is still very rare.

This system is one of the least expensive to construct (capital cost) however the maintenance costs may be considerable, depending on the depth of the pit and how often it must be emptied. If the ground is appropriate, i.e. good absorptive capacity, the pit may be dug very deep (e.g. >5m) and can be used for several years (up to 30 years) without emptying.

All types of solid cleansing materials can be discarded into the pit, although they may shorten the life of the pit and make pit emptying more difficult. Whenever possible, solid cleansing materials should be disposed of separately.



## Sanitation System 2:

## Waterless System with Alternating Pits

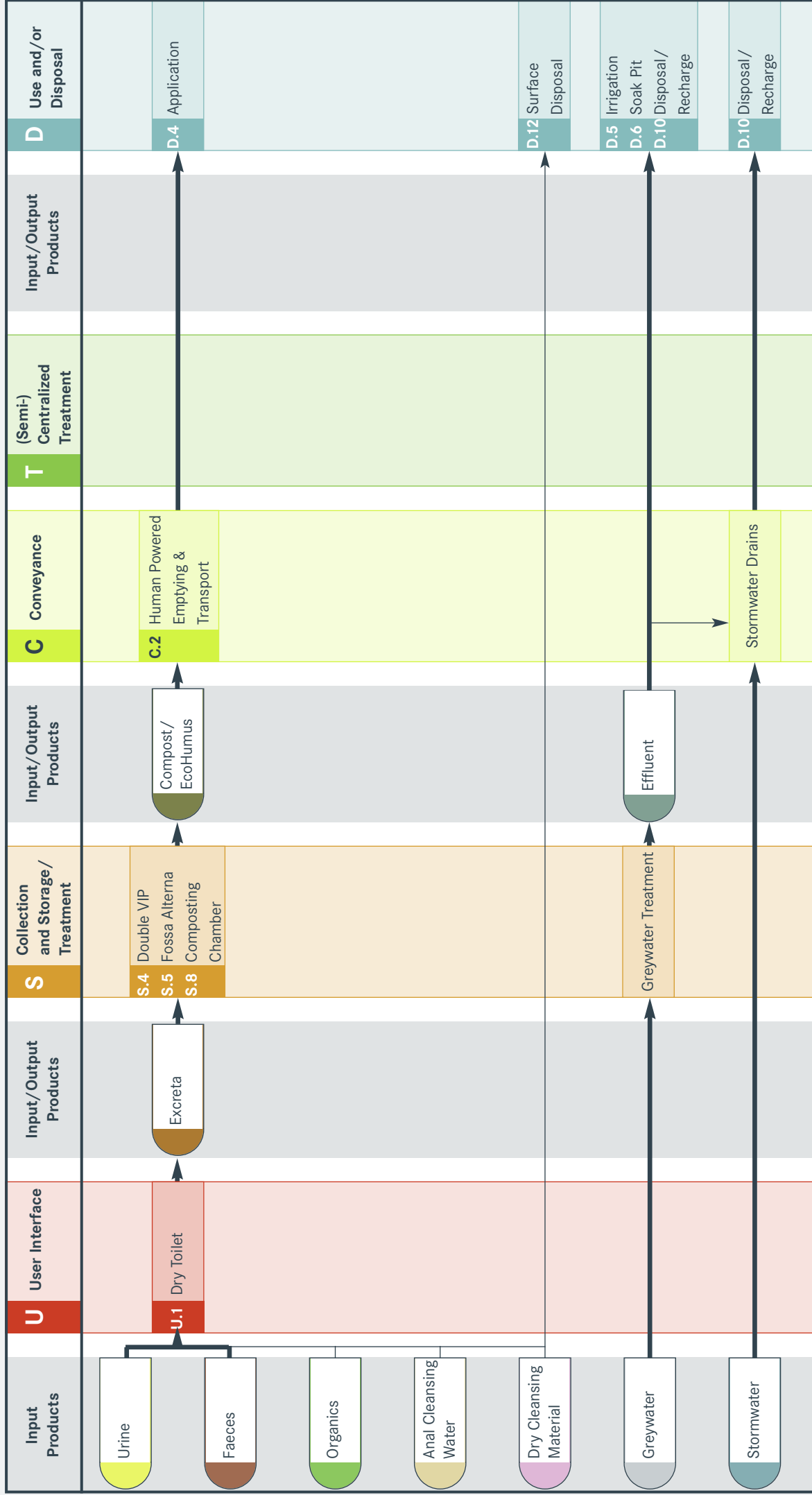

## System 2: Waterless System with Alternating Pits

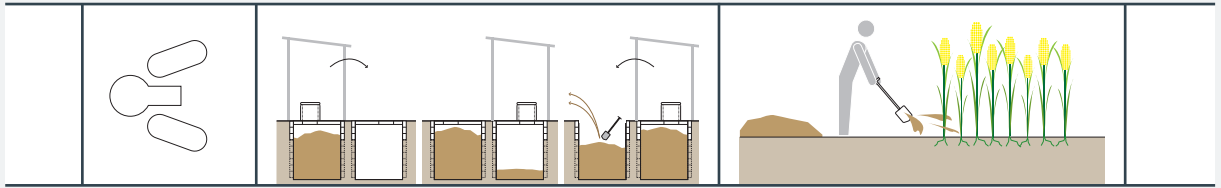

This system is designed to produce a dense, compost-like material by using alternating pits without the addition of Flushwater.

The inputs to the system can include Urine, Faeces, Organics, Anal Cleansing Water, and Dry Cleansing Materials.

A Dry Toilet (U1) is the only recommended User Interface for this system. A Dry Toilet does not require water to function and in fact, water should not be input into this system; Anal Cleansing Water should be kept to a minimum or even excluded from this system if possible. Depending on the Collection and Storage/Treatment Technology, the Dry Cleansing Materials can be added to the pit, otherwise they should be collected separately and directly transferred for disposal (D12).

Excreta is produced at the User Interface. The User Interface is connected directly to a Collection and Storage/Treatment Technology: a Double VIP (S4), Fossa Alterna (S5) or a Composting Chamber (S8). Alternating the pits gives the material an opportunity to drain, degrade, and transform into a nutrient-rich, hygienically-improved, humic material that can be used or disposed of safely. While one pit is filling with Excreta (and potentially organic material), the other pit remains out of service. When the first pit is full, it is covered and temporarily taken out of service. The drained and degraded Excreta within the second pit is emptied and the pit is put back into service. The second pit collects Excreta until it is filled, covered and taken out of service and the cycle is repeated indefinitely. Although a 'Composting Chamber' is not strictly an alternating pit technology, it can have multiple chambers and produces a safe, useable compost-Product. For these reasons it is included in this System Template.

The Compost/EcoHumus that is generated from the Collection and Storage/Treatment Technology can be removed and transported for Use and/or Disposal manually using a Human Powered E&T (C2) Conveyance Technology. Since it has undergone significant degradation, the humic material is quite safe to handle and use in agriculture. If there are concerns about the quality, it can be composted further in a dedicated composting facility but there is no need to transport

the Compost/EcoHumus to a (Semi-) Centralized Treatment facility as decomposition of the Excreta takes place onsite.

For the Use and/or Disposal of Compost/EcoHumus, the Application of Compost/EcoHumus (D4) Technology is utilized.

This system is different than System 1 because of the Conveyance and Use and/or Disposal options: in the previous system, the sludge requires further treatment before it can be used, whereas the Compost/EcoHumus produced in this system is ready for Use and/or Disposal following Collection and Storage/Treatment.

**Considerations** Because the system is permanent and can be used indefinitely (as opposed to some single pits, which may be filled and covered), it can be used where space is limited. Additionally, because the Product must be removed manually, this system is appropriate for dense areas that do not have access to mechanical emptying/trucks.

The success of this system depends on an extended storage period. If a suitable and continuous source of soil, ash or organic matter (leaves, grass clippings, coconut or rice husks, woodchips, etc.) is available, the decomposition process is enhanced and the storage period can be reduced. The storage period can be minimized if the material in the pit remains well aerated and not too moist. Therefore, the Greywater must be collected and treated separately. Too much moisture in the pit will fill the air-voids and deprive the microbes of oxygen, which may impair the degradation process.

This system is especially appropriate for water-scarce areas and where there is an opportunity to use the humic material. Dry cleansing materials can be discarded into the pit/chamber, especially if they are carbonaceous (e.g. toilet paper, newsprint, corncobs, etc.) as this may help with degradation and airflow.



## System 3: Pour Flush System with Twin Pits

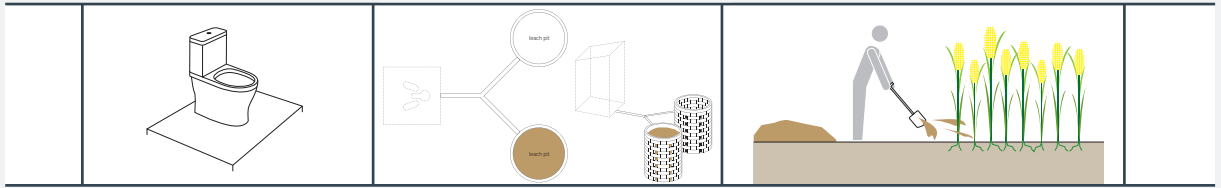

This is a water-based system utilizing the Pour Flush Toilet (pedestal or squat pan) to produce a partially digested, humus-like Product, which can be used as a soil amendment. If water is not available, please refer to Systems 1, 2 and 4. Greywater can be used in system and does not require separate treatment.

The inputs to the system can include Faeces, Urine, Flushwater, Anal Cleansing Water, Dry Cleansing Materials and Greywater.

The User Interface Technology for this system is a Pour Flush toilet (U4). A Urinal (U3) should only be used in addition to, and not instead of, the Pour Flush Toilet.

Twin Pits for Pour Flush (S6) is one of the technologies used for the Collection and Storage/Treatment of the Blackwater output from the User Interface. The Twin Pits are lined with a porous material that allows the Effluent to infiltrate into the ground while solids accumulate and degrade at the bottom of the pit. While one pit is filling with Blackwater, the other pit remains out of service. When the first pit is full, it is covered and temporarily taken out of service. It should take a minimum of two (2) years to fill a pit. When the second pit is full, the first pit is re-opened and the contents are removed. The Treated Sludge that is generated in the pit after two (2) years is removed and transported for Use and/or Disposal manually using a Human Powered E&T (C2) Conveyance Technology. Since it has undergone significant degradation, it is not as pathogenic as raw, undigested sludge. There is no need to transport the treated sludge to a (Semi-) Centralized Treatment facility as treatment of the Blackwater takes place onsite.

Dry Cleansing Materials may clog the pit and prevent water from infiltrating into the soil and so it should be collected separately and transferred for Surface Disposal (D12).

Alternatively, the blackwater can be directed towards an Anaerobic Biogas Reactor (S12). The reactor will function better if animal manure and organic waste are also added; liquid inputs like Greywater should be kept to a minimum. The Biogas that is generated (not shown) can be used for cooking, and the Treated Sludge can be used as a soil amendment.

For the Use and/or Disposal component of the System Template, the Application of Sludge (D11) Technology is utilized. Effluent from the Twin Pits for Pour Flush (S6) is directly Infiltrated into the soil (D10) onsite from each pit. Therefore, this system should only be installed where there is a low groundwater table that is not at risk of contamination from these pits.

**Considerations** Depending on the Collection and Storage/Treatment technology chosen, the system will depend on different criteria. In the case of the double pits, the system will depend on soil which can continually and adequately absorb moisture; clayey or densely packed soils are not appropriate. The material that is removed should be in a safe, useable form, although the task of removing, transporting and using it may not be favourable in some circumstances. The use of a household biogas digester is best suited to peri-urban or rural areas where there is a source of organic and/or animal waste material and a need for the digested sludge. The piping system for the gas must be well maintained to prevent leaks and potential explosions. This system is well-suited for anal cleansing with water. Dry cleansing materials should be disposed of separately because they could easily clog the pit or the reactor (D12).

# Sanitation System 4:

# Waterless System with Urine Diversion

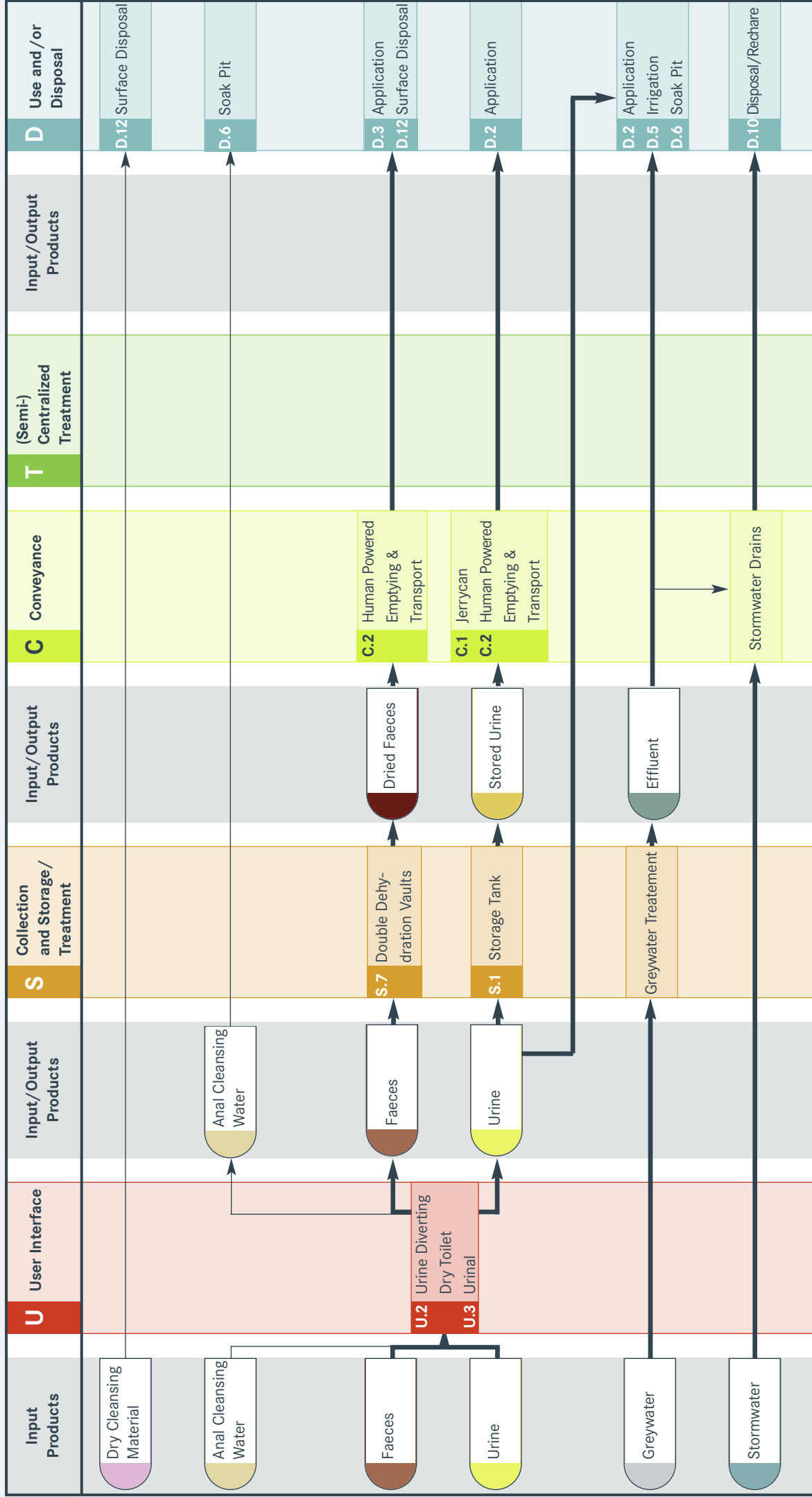

## System 4: Waterless System with Urine Diversion

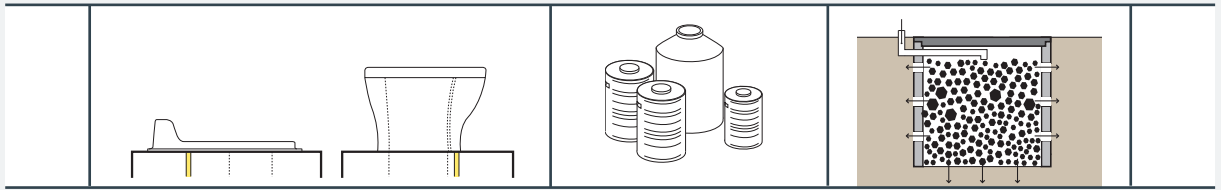

This system is designed to separate Urine and Faeces to allow Faeces to dehydrate and/or recover the Urine for beneficial use. This system can be used anywhere, but it is especially appropriate for rocky areas where digging is difficult, where there is a high groundwater table, or in water-scarce regions.

The inputs to the system can include Faeces, Urine, Anal Cleansing Water and Dry Cleansing Materials.

There are two User Interface Technologies for this system; a Urine Diverting Dry Toilet (UDDT) (U2) or a Urinal (U3). UDDTs with a third diversion for Anal Cleansing Water are not common, but can be manufactured locally or ordered depending on local washing customs. Dry cleansing materials will not harm the system, but they should be collected separately from the UDDT (U2) and directly transferred for Surface Disposal (D12).

Double Dehydration Vaults (S7) are used for the Collection and Storage/Treatment Technology for Faeces. Anal Cleansing Water should never be put into Dehydration Vaults, but it can be diverted and put into a Soak Pit (D6). When storing the Faeces in chambers, they should be kept as dry as possible to encourage dehydration and hygienization. Therefore, the chambers should be watertight and care should be taken to ensure that no water is introduced during cleaning.

Also important is a constant supply of ash, lime, or dry earth to cover the Faeces to minimize odours and provide a barrier between the Faeces and potential vectors (flies). The pH increase will also help to kill organisms. A separate Greywater system is required since it should not be introduced into the Dehydration Vaults and preferably not into the pits.

Urine can be disposed of easily and without risk to the environment because it is generated in relatively small volumes and is nearly sterile. The Urine can be diverted directly to the ground for Use and/or Disposal as Land Application (D2), Irrigation (D5) or soil infiltration through a Soak Pit (D6). Storage Tanks (S1) can be used for the Collection Storage/Treatment of Urine.

The Dried Faeces that are generated from the Collection and Storage/Treatment Technology can be removed and transported for Use and/or Disposal. The Conveyance Technology that can be used is Human Powered E&T (C2). The Dried Faeces pose little human

health risk. Stored Urine can be transported for Use and/or Disposal using either the Jerrycan (C1) or Motorized E&T (C3) Technologies.

Guidelines for the safe use of Excreta, Faecal Sludge and Urine have been published by the World Health Organization (WHO) and are referenced on the relevant Technology Information Sheets.

**Considerations** The success of this system depends on the efficient separation of urine and faeces as well as the use of a suitable drying agent; a dry, hot climate can also contribute considerably to the rapid dehydration of the faeces. The system can be used regardless of the users' acceptance to Urine use; it can be adapted to suit the agricultural and cultural needs of the users.

All types of solid cleansing materials can be used, although they should be discarded separately. Anal Cleansing Water must be separated from the Faeces although it can be mixed with the Urine before it is transferred to the Soak Pit (not shown in the System Template). If Urine is used in agriculture, Anal Cleansing Water should be kept separate and treated along with Greywater.

# Sanitation System 5: Blackwater Treatment System with Infiltration

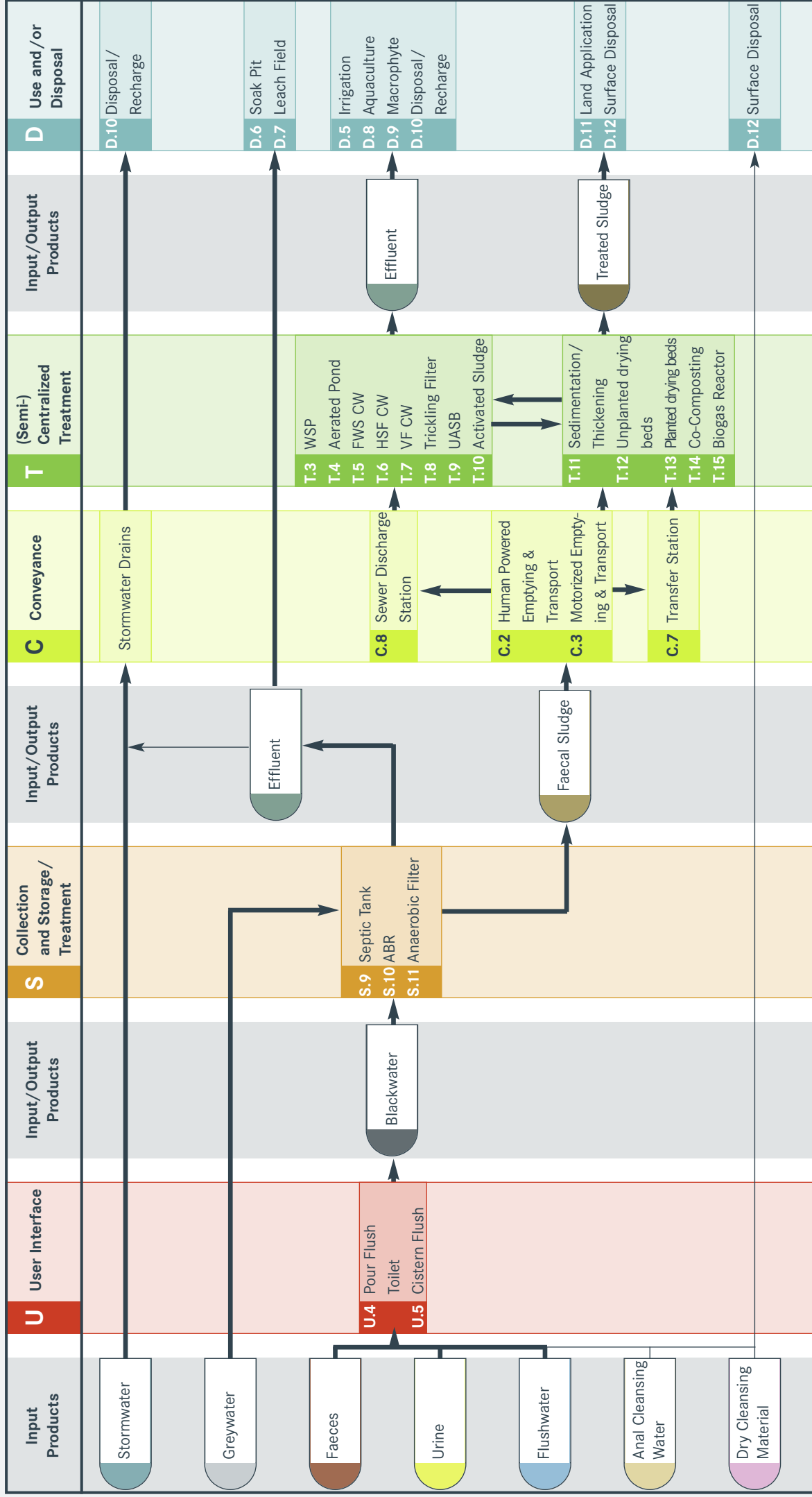

## System 5: Blackwater Treatment System with Infiltration

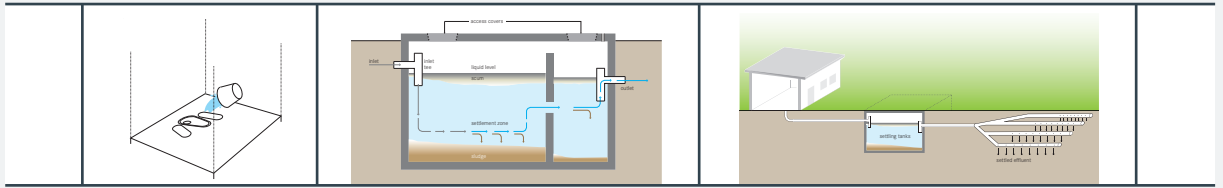

This is a water-based system that requires a flush toilet and a Collection & Storage/Treatment Technology that is appropriate for storing large quantities of water.

The inputs to the system can include Faeces, Urine, Flushwater, Anal Cleansing Water, Dry Cleansing Materials and Greywater.

There are two User Interface Technologies that could be used for this system: a Pour Flush Toilet (U4) or a Cistern Flush Toilet (U5). In the event that Dry Cleansing Materials are collected separately from the flush toilets, they can be directly transferred for Surface Disposal (D12).

The User Interface is directly connected to a Collection and Storage/Treatment Technology for the Blackwater generated: either a Septic Tank (S9), a Anaerobic Baffled Reactor (ABR) (S10), or an Anaerobic Filter (S11) may be used. The anaerobic processes reduce the organic and pathogen load, but the Effluent is still not suitable for direct use. Greywater should be treated along with Blackwater in the same Collection & Storage/Treatment Technology, but if there is a need for water-recovery, it can be treated separately (not shown on the System Template).

Effluent generated from the Collection and Storage/Treatment can be diverted directly to the ground for Use and/or Disposal through a Soak Pit (D6) or a Leach Field (D7). For these Technologies to work there must be sufficient space available and the soil must have a suitable capacity to absorb the Effluent. If this is not the case, refer to System 6: Blackwater Treatment System with Sewerage. Although it is not recommended, the Effluent can also be discharged into the Stormwater Drainage network for Use and/or Disposal as Groundwater Recharge (D10). This should only be considered if the quality of the Effluent is high and there is not capacity for onsite infiltration or transportation offsite.

The Faecal Sludge that is generated from the Collection and Storage/Treatment Technology must be removed and transported for further treatment. The Conveyance Technologies that can be used include Human Powered E&T (C2) or Motorized E&T (C3). As the Faecal Sludge is highly pathogenic prior to treatment, human contact and direct agricultural applications should be avoided.

Faecal Sludge that is removed can be transported to a dedicated Faecal Sludge treatment facility (Technologies T11 to T15). In the event that the treatment facility is not easily accessible, the Faecal Sludge can be discharged to either a Sewer Discharge Station (C8) or a Transfer Station (C7). From the Sewer Discharge Station, the Faecal Sludge is transported by the sewer and is co-treated with the Blackwater flowing in the sewer network (Technologies T1 to T10). The Faecal Sludge from the Sewer Discharge station is released either directly into the sewer or at timed intervals (to optimize the performance of the (Semi-) Centralized Treatment facility). If sludge is introduced directly into a sewer, there must be enough water to adequately dilute and transport the sludge to the treatment facility. From the Transfer Station, the Faecal Sludge must be transported to a dedicated Faecal Sludge treatment facility by a motorized vehicle (Technologies T11 to T15).

All (Semi-) Centralized Treatment Technologies, T1 to T15, produce both Effluent and Faecal Sludge, which require further treatment prior to Use and/or Disposal. Technologies for the Use and/or Disposal of the treated Effluent include Irrigation (D5), Aquaculture (D8), Macrophyte Pond (D9) or Discharge to a water body or Recharge to groundwater (D10). Technologies for the Use and/or Disposal of the treated Faecal Sludge include Land Application (D11) or Surface Disposal (D12).

**Considerations** This system is only appropriate in areas where desludging services are available and affordable and where there is an appropriate way to dispose of the sludge. This system can be adapted for use in colder climates, even where there is ground frost. The system requires a constant source of water. The capital investment for this system is considerable (excavation and installation of an onsite storage Technology), but the costs can be shared by a number of households if the system is designed for a larger number of users.

This water-based system is suitable for Anal Cleansing Water, and since the solids are settled and digested onsite, easily degradable Dry Cleansing Materials can also be used.



# Sanitation System 6: Blackwater Treatment System with Sewerage

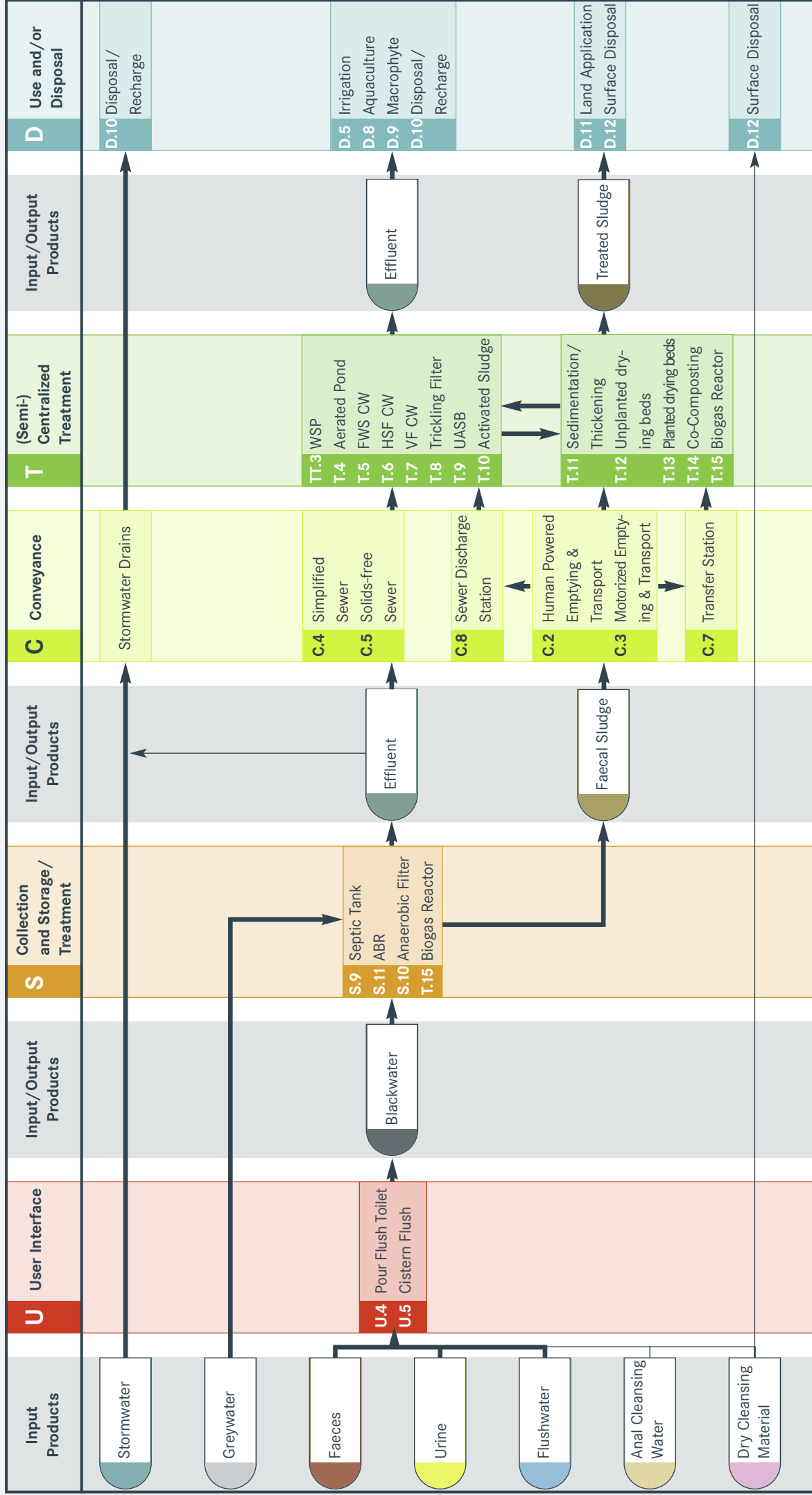

## System 6: Blackwater Treatment System with Sewerage

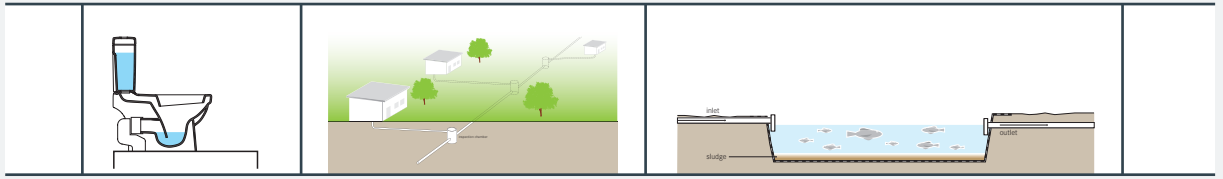

This system is characterized by the use of a household-level Technology to remove and digest settleable solids from the Blackwater, and a simplified or settled sewer system to transport the Effluent to a (Semi-) Centralized Treatment facility.

The inputs to the system can include Faeces, Urine, Flushwater, Anal Cleansing Water, Dry Cleansing Materials and Greywater. This system is comparable to System 5: Blackwater Treatment System with Infiltration except the management and processing of the Effluent generated during Collection and Storage /Treatment of the Blackwater is different. As such, please refer to System Template for System 5: Blackwater Treatment System with Infiltration, for a detailed description of the components.

There are two transport pathways for the Effluent generated from the Collection and Storage/Treatment of the Blackwater. Similar to System 5, Effluent can be discharged into the Stormwater Drainage network for Use and/or Disposal as Groundwater Recharge (D10), although this is not the recommended approach. The Effluent should be transported from a Collection and Storage/Treatment facility to a (Semi-) Centralized Treatment facility via a Simplified Sewer network (C4) or a Solids-Free Sewer network (C5). An interceptor tank is required before the Effluent enters the sewer, or alternatively, this system can be used as a way of upgrading under-performing onsite Technologies (e.g. septic tanks) by providing improved, (Semi-) Centralized Treatment. Effluent transported to a (Semi-) Centralized Treatment facility is treated using one of the Technologies T1 to T10.

All (Semi-) Centralized Treatment Technologies, T1 to T15, produce both Effluent and Faecal Sludge, which require further treatment prior to Use and/or Disposal. Technologies for the Use and/or Disposal of the treated Effluent include Irrigation (D5), Aquaculture (D8), Macrophyte Pond (D9) or Discharge to a water body or Recharge to Groundwater (D10). Technologies for the Use and/or Disposal of the treated Faecal Sludge include Land Application (D11) or Surface Disposal (D12).

**Considerations** With the offsite transport of the Effluent to a (Semi-) Centralized Treatment facility, the capital investment for this system is moderate to considerable. Excavation and installation of the onsite storage technology as well as the infrastructure required for the simplified sewer network may be costly (although costs would be considerably less than the design and installation of a conventional sewer network). As well, if there is no pre-existing treatment facility, one must be built to ensure that discharge from the sewer is not directly input to a water body.

The success of this system depends on high user commitment to operation and maintenance of the sewer network; alternatively, a person or organization can be made responsible on behalf of the users. There must be an accessible, affordable and systematic method for desludging the interceptor (or septic) tanks since one user's improperly kept tank could adversely impact the entire community. Also important is a well-functioning and properly managed Centralized Treatment facility; in some cases this will be managed at the municipal /regional level, but in the case of a more local solution (e.g. wetland), there must also be a well-defined structure for operation and maintenance.

This system is especially appropriate for dense, urban settlements where there is little or no space for onsite storage technologies or emptying. Since the sewer network is shallow and (ideally) watertight, it is also applicable for areas with high groundwater tables.

This water-based system is suitable for Anal Cleansing Water inputs, and, since the solids are settled and digested in one of the Collection and Storage/Treatment Technologies, easily degradable Dry Cleansing Materials can also be used. However, durable materials (e.g. leaves, rags) could clog the system and cause problems with emptying and therefore, should not be used.

# Sanitation System 7: (Semi-) Centralized Treatment System

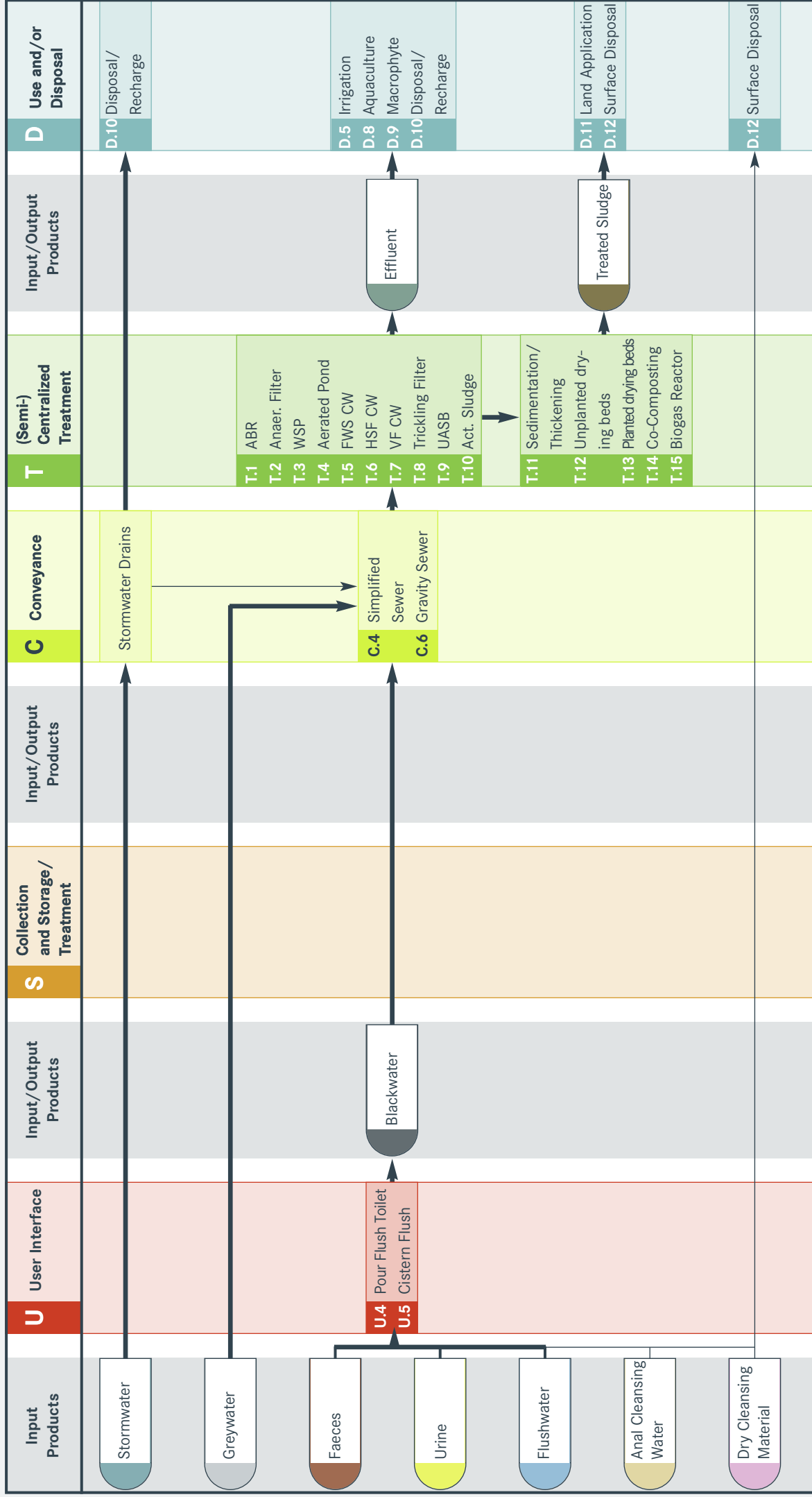

## System 7: (Semi-) Centralized Treatment System

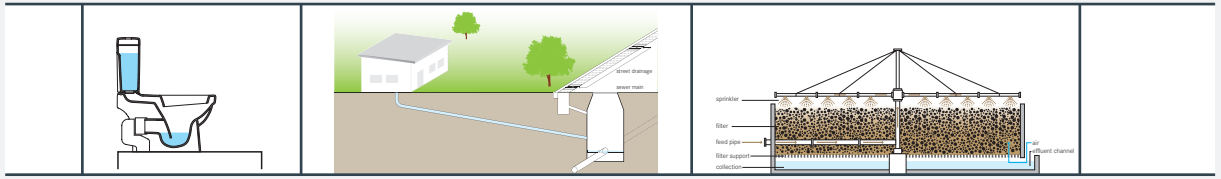

This is a water-based sewer system in which Blackwater is transported to a centralized treatment facility. The important characteristic of this system is that there is no Collection and Storage/Treatment.

The inputs to the system include Faeces, Urine, Flushwater, Anal Cleansing Water, Dry Cleansing Materials, Stormwater, and Greywater.

There are two User Interface Technologies that can be used for this system, a Pour Flush Toilet (U4) or a Cistern Flush Toilet (U5). Dry Cleansing Materials can be handled by the system or they can be collected separately and directly transferred for Surface Disposal (D12).

The Blackwater generated at the User Interface is directly connected to a (Semi-) Centralized Treatment facility by a Simplified Sewer network (C4) or a Gravity Sewer network (C6). Greywater is co-treated with the Blackwater. Stormwater collected within the Stormwater drains can be input to the Gravity Sewer network, although Stormwater overflows are required.

As there is no Collection and Storage/Treatment, all of the Blackwater is transported to a (Semi-) Centralized Treatment facility. The inclusion of Greywater in the Conveyance Technology helps to prevent solids from accumulating in the sewers. One of the Technologies T1 to T10 is required for the treatment of the transported Blackwater. The Faecal Sludge generated from the treatment of the Technologies T1 to T10 must be further treated in a dedicated Faecal Sludge treatment facility (Technologies T11 to T15) prior to Use and/or Disposal.

All (Semi-) Centralized Treatment Technologies, T1 to T15, produce both Effluent and Faecal Sludge. Technologies for the Use and/or Disposal of the treated Effluent include Irrigation (D5), Aquaculture (D8), Macrophyte Pond (D9) or Discharge to a water body or Recharge to groundwater (D10). Technologies for the Use and/or Disposal of the treated Faecal Sludge include Land Application (D11) or Surface Disposal (D12).

**Considerations** The capital investment for this system can be high; gravity sewers require extensive excavation and installation can be expensive, whereas Simplified Sewers are generally less expensive if the site conditions permit a condominal design. This system is only appropriate when there is a high willingness to pay for the capital investment and maintenance costs and where there is a pre-existing treatment facility that has the capacity to accept additional flow.

Depending on the type of sewers used, this system can be adapted for both dense urban and peri-urban areas. It is not well-suited to rural areas. There must be a constant supply of water to ensure that the sewers do not become blocked. Users may be required to pay user-fees to pay for the centralized treatment and maintenance.

Depending on the sewer type and management structure (simplified vs gravity, city-run vs community operated) there are varying degrees of operation or maintenance responsibilities for the homeowner.

# Sanitation System 8: Sewerage System with Urine Diversion

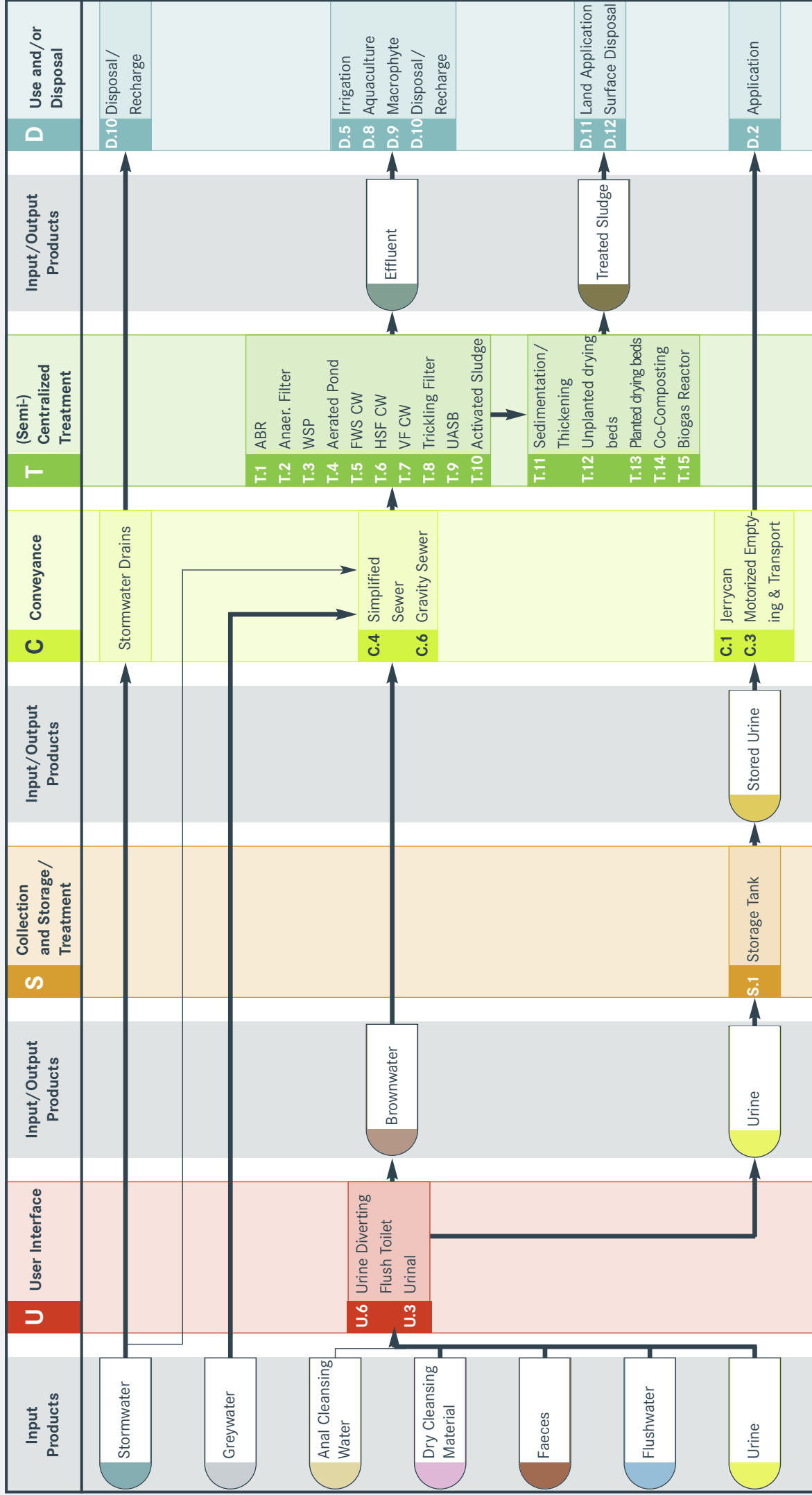

## System 8: Sewerage System with Urine Diversion

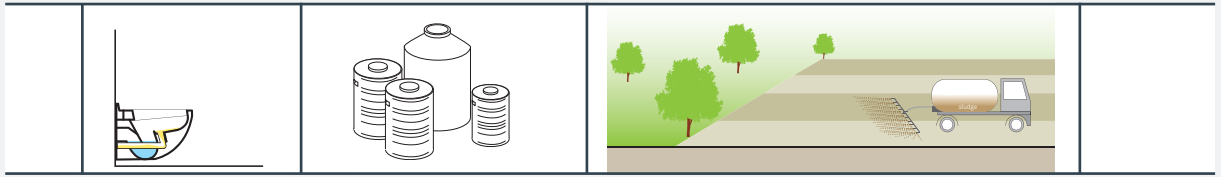

This is a water-based sewer system that requires a Urine Diverting Flush Toilet (UDFT). The UDFT is a special User Interface that allows for the separation and collection of Urine without water, but that also uses water to flush Faeces.

The inputs to the system can include, Faeces, Urine, Flushwater, Anal Cleansing Water, Dry Cleansing Material, Stormwater, and Greywater.

There are two User Interface Technologies that can be used for this system, a UDFT (U6) and a Urinal (U3). The Urinal however, should be used in conjunction with the UDFT, as an alternative for men who do not wish to sit on the pedestal.

Both Brownwater and Urine are separated at the User Interface. Brownwater bypasses a Collection and Storage/Treatment facility and is conveyed directly to a (Semi-) Centralized Treatment facility using a Simplified Sewer network (C4) or a Gravity Sewer network (C6). Greywater is also transported in the sewer and is not treated separately. In some circumstances, Stormwater can be connected to a Gravity Sewer network, although Stormwater overflows are required.

Urine separated at the User Interface is directly linked to a Storage Tank (S1). The Stored Urine is transferred for Use and/or Disposal using a Jerrycan (C1) or Motorized E&T (C3) for Urine Application to agricultural lands (D2).

Brownwater is treated at a (Semi-) Centralized Treatment facility using one of the Technologies T1 to T10. The Faecal Sludge generated from the treatment of the Technologies T1 to T10 must be further treated in a dedicated Faecal Sludge treatment facility (Technologies T11 to T15) prior to using the Land Application (D11) or Surface Disposal (D12) Use and/or Disposal technologies. Technologies for the Use and/or Disposal of the treated Effluent collected from one of the Technologies T1 to T10 include Irrigation (D5), Aquaculture (D8), Macrophyte Pond (D9) or Discharge to a water body or Recharge to Groundwater (D10).

**Considerations** UDFTs are not common and the capital cost for this system can be high. This is partly due to the fact that there is limited competition in the market and also because high quality plumbing is required for the dual plumbing system. The Gravity Sewers require extensive excavation and installation can be expensive, whereas Simplified Sewers are generally less expensive if the site conditions permit a condominium design. This system is only appropriate when there is a need for the separated Urine and/or when there is a desire to limit water consumption by collecting Urine without flushing water. The system still requires a constant source of water and uses significantly more than a waterless system.

Depending on the type of sewers used, this system can be adapted for both dense urban and peri-urban areas. It is not well-suited to rural areas. There must be a constant supply of water to ensure that the sewers do not become blocked. This system is appropriate where there is a need and a desire to collect, transport and use the Urine. There may also be benefits to the treatment plant if it is normally overloaded; the reduced nutrient load (by removing the Urine) could optimize treatment. However, if the plant is currently, underloaded (i.e. the plant has been oversized) then this system could further aggravate the problem.

Depending on the sewer type and management structure (simplified vs gravity, city-run vs community operated) there will be varying degrees of operation or maintenance responsibilities for the homeowner.



### **Reading the Technology Information Sheets**

For each Technology described in the System Templates, there is a Technology Information Sheet which includes a summary of the Technology, appropriate applications and limitations. The page is not intended to be a design manual or technical reference; rather it is a starting point for further detailed design. Moreover, the Technology descriptions are meant to serve as a source of inspiration and discussion amongst engineers and planners who may not have previously considered one or several of the feasible options.

Each Technology Information Sheet is colour coded according to the associated **Functional Group**. The letter code (e.g. U for User Interface) also indicates the Functional Group to which the Technology belongs. Figure 5 on the following page presents and explains an example of a Technology Information Sheet heading.



<b>S.9</b> <b>Septic Tank</b>		Applicable to: <b>System 5, 6</b>
<b>Application Level</b> <input checked="" type="checkbox"/> Household <input checked="" type="checkbox"/> Neighbourhood <input type="checkbox"/> City	<b>Management Level</b> <input checked="" type="checkbox"/> Household <input checked="" type="checkbox"/> Shared <input checked="" type="checkbox"/> Public	<b>Inputs:</b> <input checked="" type="checkbox"/> Blackwater <input type="checkbox"/> Greywater <b>Outputs:</b> <input checked="" type="checkbox"/> Faecal Sludge <input type="checkbox"/> Effluent

Figure 5. Heading and subheading of a Technology Information Sheet

**1) The title with colour, letter and number code.** The colour-code (orange) and the letter (S) indicate that the Technology belongs to the Functional Group ‘Collection and Storage/Treatment (S)’. The number (9) indicates that it is the ninth (9th) technology within that Functional Group. Each Technology description page has a similar colour, letter and number code for easy access and cross-referencing.

**2) Applicable to System 5, 6.** This indicates in which System Template the Technology can be found. In this case, the Septic Tank can be found (and only found) in System 5 and 6. Other Technologies may be found in only one or in several systems.

**3) Application Level.** Three spatial levels are defined under this heading:

- *Household* implies that the technology is appropriate for one or several households
- *Neighbourhood* implies that the technology is appropriate for several up to several hundred households
- *City* implies that the technology is appropriate at the city-wide level (either one unit for the whole city, or many units for each part of the city or household)

Stars are used to indicate how appropriate each level is for the given technology:

- *two stars* means suitable,
- *one star* means less suitable; and
- *no star* means not suitable.

It is up to the Compendium user to decide on the appropriate level for the specific situation that he/she is working on.

The ‘Application Level’ graphic is only meant as a rough guide to be used in the preliminary planning stage.

The technologies within the Functional Group ‘User Interface’ do not include an Application Level since they can only service a limited number of people.

**4) Management Level** describes the organizational style that is best used for the operation and maintenance (O&M) of the given Technology:

- *Household* implies that the household, e.g. the family, is responsible for all O&M
- *Shared* implies that a group of users (e.g. school, market vendors, community-based organization) assumes the O&M themselves either by ensuring that a person or committee is responsible on behalf of all the users. Shared facilities are defined by the fact that the community of users decides who is allowed to use the facility and what their responsibilities are; it is a self-defined group of users.
- *Public* implies institutional or government run facilities. All O&M is assumed by the agency that operates the facility. Usually, only users who can pay for the service are permitted to use public facilities.

The Septic Tank in this example can be managed in all three styles.

The technologies within the Functional Group ‘User Interface’ do not include a Management Level since maintenance is dependent on the subsequent technologies, and not simply the User Interface.



**5) Inputs:** refers to the Products that flow into the given Technology. The icons shown are those Products that can possibly go into the Technology, but not all of them MUST enter the technology. In this example, Blackwater and Greywater can be processed by the Septic Tank

**6) Outputs:** refers to the products that flow out of the given Technology. The icons show those Products that can be expected to flow out of the technology. In this example, the Septic Tank produces Faecal Sludge and Effluent.

This section describes the technologies with which the user interacts. The User Interface is the way in which the sanitation system is accessed.





**Inputs:**  Faeces  Urine  
 Anal Cleansing Water

**Outputs:**  Excreta

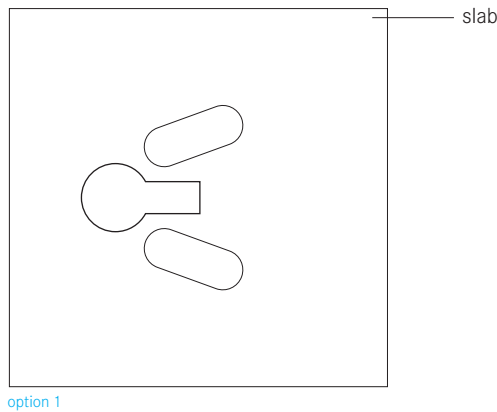

option 1

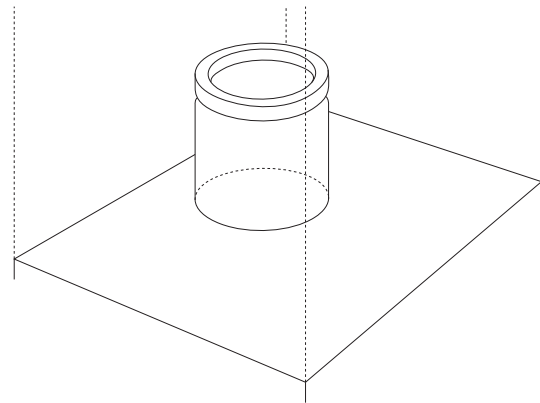

option 2

**A Dry Toilet is a toilet that operates without water. The Dry Toilet may be a raised pedestal that the user can sit on, or a squat pan that the user squats over. In both cases, excreta (both urine and faeces) fall through a drop hole.**

In this Compendium, a Dry Toilet refers specifically to the device that the user sits or squats over. In other literature, a Dry Toilet may refer to a variety of technologies, or combinations of technologies (especially pits).

The Dry Toilet is usually placed over a pit; if two pits are used, the pedestal or slab should be designed in such a way that it can be lifted and moved from one pit to another.

The slab or pedestal base should be well sized to the pit so that it is both safe for the user and prevents stormwater from infiltrating the pit (which may cause it to overflow).

**Adequacy** Dry Toilets are easy for almost everyone to use. Because there is no need to separate urine and faeces, they are often the most physically comfortable and natural option.

Pedestals and squatting slabs can be made locally with concrete (providing that sand and cement are available). Wooden or metal molds can be used to produce several units quickly and efficiently. When dry toilets are made locally, they can be specially designed to meet the needs of the target users (e.g. smaller ones for children). Fibreglass, porcelain and stainless steel versions may also be available. They are appropriate for almost every climate.

**Health Aspects/Acceptance** Squatting is a natural position for many people and so a well-kept squatting slab may be the most acceptable option. Since Dry Toilets do not have a water seal, odours may be a problem depending on the Collection and Storage/Treatment technology to which it is connected.

**Maintenance** The sitting or standing surface should be kept clean and dry to prevent pathogen/disease transmission and to limit odours.

There are no mechanical parts and so the Dry Toilet should not need repairs except in the event that it cracks.

**Pros & Cons:**

- + Does not require a constant source of water
- + Can be built and repaired with locally available materials
- + Low capital and operating costs
- + Suitable for all types of users (sitters, squatters, washers, wipers)
- Odours are normally noticeable (even if the vault or pit used to collect excreta is equipped with a vent pipe).
- The excreta pile is visible, except where a deep pit is used

**References**

- 
- \_ Brandberg, B. (1997). *Latrine Building. A Handbook for Implementation of the Sanplat System*. Intermediate Technology Publications, London. pp 55–77  
(Describes how to build a squatting slab and the moulds for the frame, footrests, spacers, etc.)
  - \_ Morgan, P. (2007). *Toilets That Make Compost: Low-cost, sanitary toilets that produce valuable compost for crops in an African context*. Stockholm Environment Institute, Sweden.  
(Excellent description of how to make support rings and squatting slabs (pages 7–35) and pedestals (39–43) using only sand, cement, plastic sheeting and wire.)  
Available: [www.ecosanres.org](http://www.ecosanres.org)
  - \_ Netherlands Water Partnership (NWP) (2006). *Smart Sanitation Solutions. Examples of innovative, low-cost technologies for toilets, collection, transportation, treatment and use of sanitation products*. NWP, Netherlands.  
(Provides country specific data and links for further information.)

**Inputs:**  Faeces  Urine

 Anal Cleansing Water

**Outputs:**  Faeces  Urine

 Anal Cleansing Water

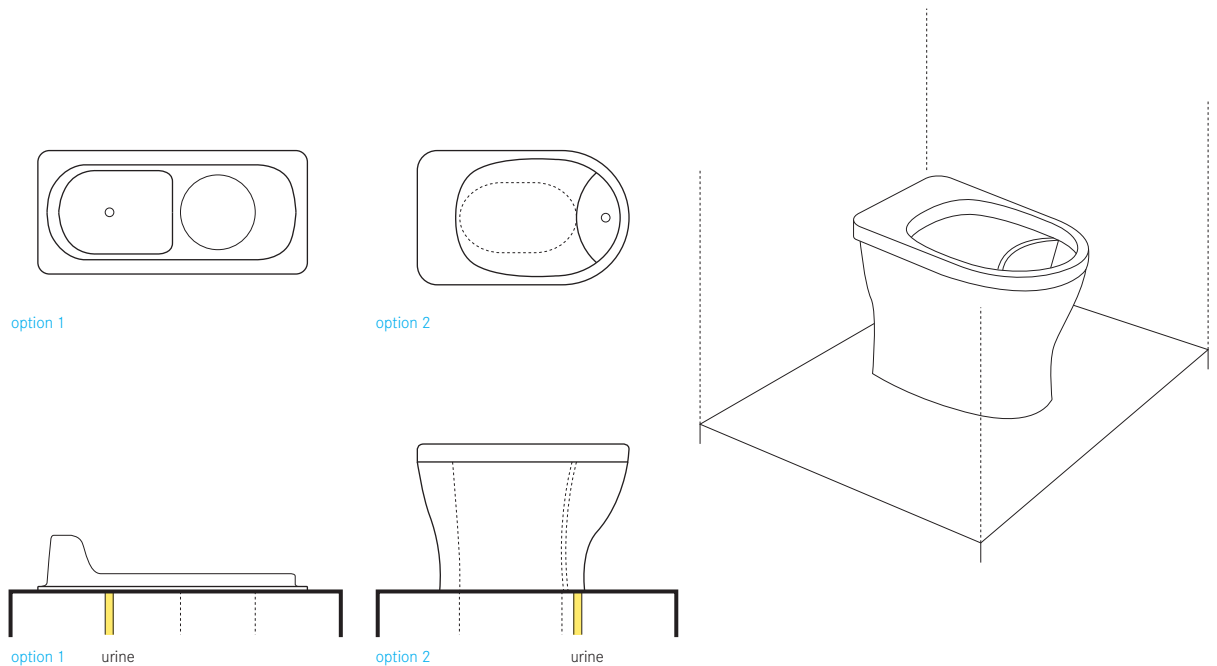

**A Urine Diverting Dry Toilet (UDDT) is a toilet that operates without water and has a divider so that the user, with little effort can divert the urine away from the faeces.**

The UDDT toilet is built such that urine is collected and drained from the front area of the toilet, while faeces fall through a large chute (hole) in the back. Depending on the Collection and Storage/Treatment technology that follows, drying material such as lime, ash or earth should be added into the same hole after defecating.

It is important that the two sections of the toilet are well separated to ensure that a) faeces do not fall into, and clog the urine collection area in the front, and that b) urine does not splash down into the dry area of the toilet.

There are also 3-hole separating toilets that allow anal cleansing water to be separated from the urine and the faeces into a third, dedicated hole. It is important that the faeces remain separate and dry. When the toilet is cleaned with water, care should be taken to ensure that the faeces are not mixed with water.

Both a pedestal and a squat slab can be used to separate urine from faeces depending on user preference.

**Adequacy** The UDDT is simple to design and build using such materials as concrete and wire mesh or plastic. The UDDT design can be altered to suit the needs of specific populations (i.e. smaller for children, people who prefer to squat, etc.) They are appropriate for almost every climate.

**Health Aspects/Acceptance** The UDDT is not intuitive or immediately obvious to some users. At first, users may be hesitant about using it and mistakes (e.g. faeces in the urine bowl) may deter others from accepting this type of toilet as well. Education and demonstration projects are essential in achieving good acceptance with users.

**Maintenance** A UDDT is slightly more difficult to keep clean compared to other toilets because of both the lack of water and the need to separate the solid faeces and liquid urine. For cleaning, a damp cloth may be used to wipe down the seat and the inner bowls. Some toilets are easily removable and can be cleaned more thoroughly. No design will work for everyone and therefore, some users may have difficulty separating both streams perfectly which may result in extra cleaning and maintenance.

Faeces can be accidentally deposited in the urine section, causing blockages and cleaning problems. As well, urine pipes/fittings can become blocked over time and may require occasional maintenance.

This is a waterless technology and water should not be poured down the toilet. As well, urine tends to rust most metals; therefore, metals should be avoided for the construction and piping of the UDDT.



#### **Pros & Cons:**



- + Does not require a constant source of water
- + No real problems with odours and vectors (flies) if used and maintained correctly (i.e. kept dry)
- + Can be built and repaired with locally available materials
- + Low capital and operation costs
- + Suitable for all types of users (sitters, squatters, washers, wipers)
- Requires education and acceptance to be used correctly
- Is prone to clogging with faeces and misuse

#### **References**

---

- \_ Morgan, P. (2007). *Toilets That Make Compost: Low-cost, sanitary toilets that produce valuable compost for crops in an African context*. Stockholm Environment Institute, Sweden. Available: [www.ecosanres.org](http://www.ecosanres.org) (Provides step-by step instruction on how to build a UDDT using a plastic bucket and how to construct a urine diverting squat plate.)
- \_ Netherlands Water Partnership (NWP) (2006). *Smart Sanitation Solutions. Examples of innovative, low-cost technologies for toilets, collection, transportation, treatment and use of sanitation products*. NWP, Netherlands. (Provides country specific data and links for further information.)
- \_ Winblad, U. and Simpson-Herbert, M. (2004). *Ecological Sanitation*. Stockholm Environment Institute, Sweden. Available: [www.ecosanres.org](http://www.ecosanres.org) (Provides a good, general overview of different types of UDDTs – see especially page 59.)

**Inputs:**  Urine  Flushwater

**Outputs:**  Urine  Flushwater

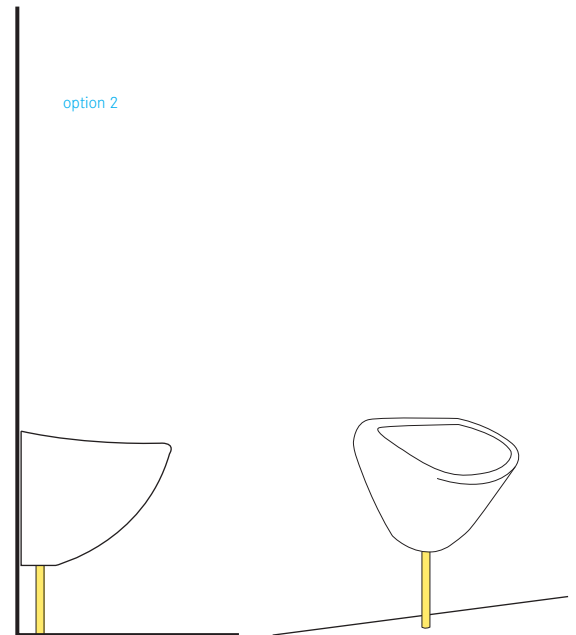
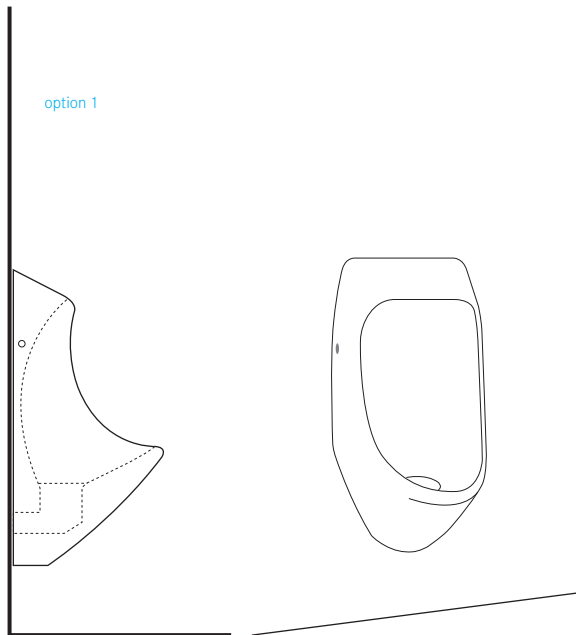

**A Urinal is only used for collecting urine. Urinals are generally for men, although Urinals for women have also been developed.**

Urinals for women consist of raised foot-steps and a sloped channel or catchment area for conducting the urine to a collection technology. For men, Urinals can either be wall-mounted units that are vertical, or squat slabs that the user squats over. Most Urinals use water for flushing, but waterless Urinals are becoming increasingly popular.

**Adequacy** The Urinal can be used with or without water and the plumbing can be developed accordingly. If water is used, it is mainly used for cleaning and limiting odours (with a water-seal). Water-based Urinals use 8 to 12 litres of flushwater, whereas low-flush models use less than 4 litres of flushwater. Because the Urinal is exclusively for urine it is important to also provide another toilet to be used for faeces. Waterless Urinals are available in a range of styles and complexities. Some Urinals come equipped with an odour seal that may have a mechanical closure, a membrane, or a sealing liquid. To minimize odours in simple

Urinal designs, each Urinal should be equipped with a dedicated pipe that is submerged in the collected urine (or tank) to provide a basic water-seal. Portable waterless Urinals have been developed for use at large festivals, concerts and other gatherings, to improve the on-site sanitation facilities and reduce the point load of wastewater discharged at the site. In this way, a large volume of urine can be collected (and either used or discharged at a more appropriate location or time) and the remaining urine/faeces toilets can be reduced or used more efficiently. Urinals can be used in homes as well as within public facilities. By putting a small target, or painted fly near the drain, the amount of spraying or splashing can be reduced; this type of user-guidance can help improve the cleanliness of the facility. Urinals are appropriate for every climate.

**Health Aspects/Acceptance** The Urinal is a comfortable and easily accepted User Interface. In some cases, the provision of a Urinal is useful to prevent the misuse of dry systems (e.g. UDDT). Urinals, although simple in construction and design, can have a large impact on the well-being of a community. When men



have access to a Urinal, they may be encouraged to refrain from urinating in public, which reduces unwanted odours and allows women to feel more comfortable.

Men have generally accepted waterless Urinals, as they do not call for any change of behaviour.

**Maintenance** Maintenance is simple, but should be done frequently. Minerals and salts may build up in pipes and on surfaces where urine is constantly present. To prevent scaling, slightly acidic water and/or hot water can be used to dissolve any minerals that form. All of the surfaces should be cleaned regularly (bowl, slab and steps) to prevent odours and to minimize solids formation.

**Pros & Cons:**

- + Does not require a constant source of water
- + Can be built and repaired with locally available materials
- + Low capital and operating costs
- No real problems with odours if used and maintained correctly

**References**

---

- Austin, A. and Duncker, L. (2002). *Urine-diversion. Ecological Sanitation Systems in South Africa*. CSIR, Pretoria, South Africa.  
(Directions for making a simple Urinal using a 5L plastic container.)
- CREPA (2008). *Promotion de latrines ECOSAN à la 20<sup>e</sup> édition du FESPACO: Ecosan Info No. 8*. Centre Régional pour l'Eau Potable et l'Assainissement à faible coût (CREPA), Burkina Faso.  
Available: [www.reseaucrepa.org](http://www.reseaucrepa.org)
- GTZ (1999). *Technical data sheets for ecosan components: Waterless Urinals*. GTZ, Germany.  
Available: [www.gtz.de](http://www.gtz.de)  
(Information about specialized urinals, which include stench traps and other specialized features.)
- Netherlands Water Partnership (NWP) (2006). *Smart Sanitation Solutions. Examples of innovative, low-cost technologies for toilets, collection, transportation, treatment and use of sanitation products*. NWP, Netherlands.  
(Provides country specific data and links for further information.)

**Inputs:**  Urine  Faeces  
 Flushwater  Anal Cleansing Water

**Outputs:**  Blackwater

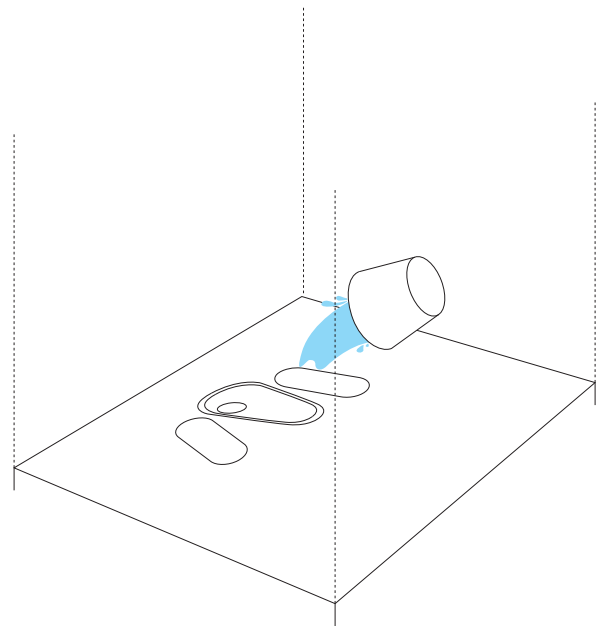
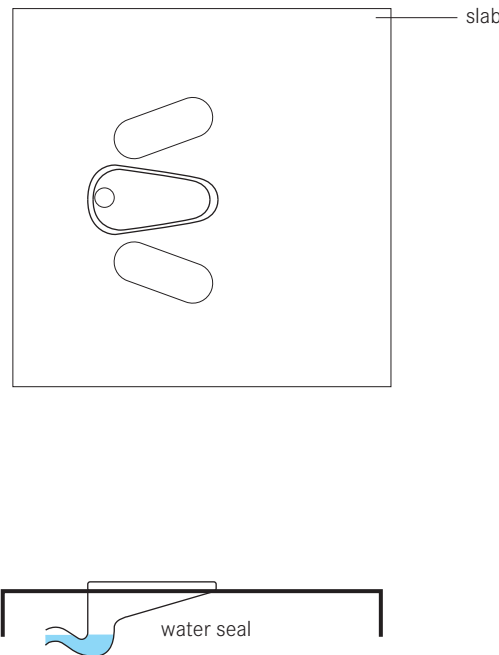

**A Pour Flush Toilet is like a regular Flush Toilet except that instead of the water coming from the cistern above, it is poured in by the user. When the water supply is not continuous, any cistern Flush Toilet can become a Pour Flush Toilet.**

Just like a traditional Flush Toilet, there is a water seal that prevents odours and flies from coming back up the pipe.

Water is poured into the bowl to flush the toilet of excreta; approximately 2 to 3L is usually sufficient. The quantity of water and the force of the water (pouring from a height often helps) must be sufficient to move the excreta up and over the curved water seal.

Both pedestals and squatting pans can be used in the pour flush mode. Due to demand, local manufacturers have become increasingly efficient at mass-producing affordable, Pour Flush Toilets and pans.

The S-shape of the water seal determines how much water is needed for flushing. To reduce water requirements, it is advisable to collect toilet paper or other dry cleansing materials separately.

The water seal at the bottom of the Pour Flush Toilet or pan should have a slope of 25 to 30°. Water seals should

be made out of plastic or ceramic to prevent clogs and to make cleaning easier (concrete may clog more easily if it is rough or textured). The optimal depth of the water seal is approximately 2cm to minimize the water required to flush the excreta. The trap should be approximately 7cm in diameter.

**Adequacy** The water seal is effective at preventing odours and it is appropriate for those who sit or squat (pedestal or slab) as well as those who cleanse with water. It is only appropriate when there is a constant supply of water available. The Pour Flush Toilet requires (much) less water than a traditional cistern Flush Toilet. However, because a smaller amount of water is used, the Pour Flush Toilet may clog more easily and thus, require more maintenance.

If water is available, this type of toilet is appropriate for both public and private applications.

Pour Flush Toilets are adequate for almost all climates.

**Health Aspects/Acceptance** The Pour Flush Toilet (or squatting pan) prevents users from seeing or smelling the excreta of previous users. Thus, it is generally well accepted. Provided that the water seal is working

well, there should be no odours and the toilet should be clean and comfortable to use.

**Maintenance** Because there are no mechanical parts, Pour Flush Toilets are quite robust and rarely require repair.

Despite the fact that water is used continuously in the toilet, it should be cleaned regularly to prevent the build up of organics and or/stains.

To prevent clogging of the Pour Flush Toilet, it is recommended that dry cleansing materials be collected separately and not flushed down the toilet.

#### **Pros & Cons:**

- + The water seal effectively prevents odours
- + The excreta of one user are flushed away before the next user arrives
- + Suitable for all types of users (sitters, squatters, wipers and washers)
- + Low capital costs; operating costs depend on the price of water
- Requires a constant source of water (can be recycled water and/or collected rain water)
- Cannot be built and/or repaired locally with available materials
- Requires some education to be used correctly

#### **References**

---

- \_ Mara, DD. (1996). *Low-Cost Urban Sanitation*. Wiley, Chichester, UK.  
(Provides detailed drawings of Indian glass-fibre squat pan and trap with dimensions and critical design criteria. A description of how to modify a Pour Flush Toilet to a cistern Flush Toilet is included.)
- \_ Roy, AK., et al. (1984). *Manual on the Design, Construction and Maintenance of Low-Cost Pour Flush Waterseal Latrines in India (UNDP Interreg. Project INT/81/047)*. The World Bank + UNDP, Washington.  
(Provides specifications for Pour Flush Toilets and connections.)

**Inputs:**  Urine  Faeces  
 Flushwater  Anal Cleansing Water

**Outputs:**  Blackwater

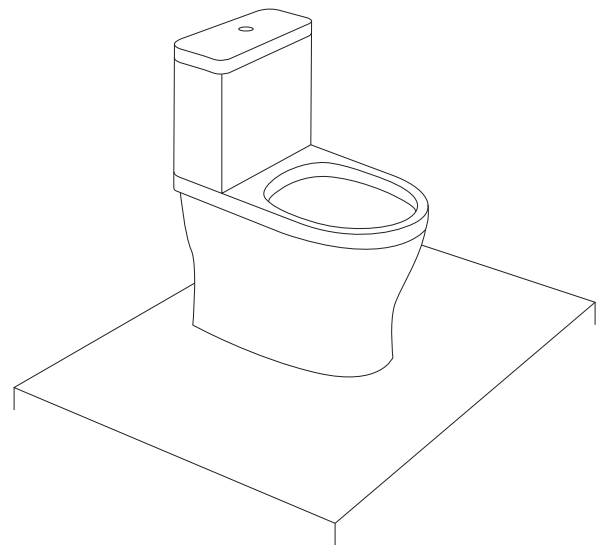
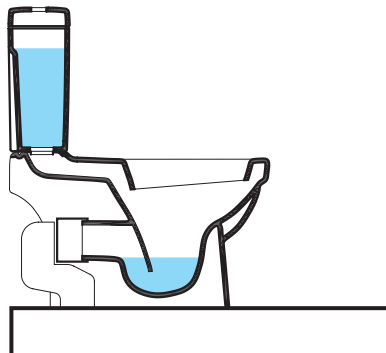
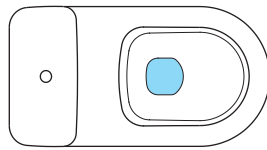

**The Cistern Flush Toilet is usually porcelain and is a mass-produced, factory made User Interface. The Flush Toilet consists of a water tank that supplies the water for flushing the excreta and a bowl into which the excreta are deposited.**

The attractive feature of the Flush Toilet is that it incorporates a sophisticated water seal to prevent odours from coming back up through the plumbing. Depending on the age and design of the toilet, approximately 3 to 20L of water may be used per flush.

Water that is stored in the cistern above the toilet bowl is released by pushing or pulling a lever. This allows the water to run into the bowl, mix with the excreta and carrying them away.

There are different low-volume Flush Toilets currently available that use as little as 3L of water per flush. In some cases, the volume of water used per flush is not sufficient to empty the bowl and consequently the user is forced to use two or more flushes to adequately clean the bowl, which negates the intended water saving.

A good plumber is required to install a Flush Toilet. The plumber will ensure that all valves are connected and sealed properly, therefore minimizing leakage.

**Adequacy** A Cistern Flush Toilet should not be considered unless all of the connections and hardware accessories are available locally.

The Cistern Flush Toilet must be connected to both a constant source of water for flushing and a Collection and Storage/Treatment or Conveyance technology to receive the blackwater.

The Cistern Flush Toilet is suitable for both public and private applications and can be used in every climate.

**Health Aspects/Acceptance** It is a safe and comfortable toilet to use provided it is kept clean.

**Maintenance** Although flushwater continuously rinses the bowl, the toilet should be scrubbed clean regularly. Maintenance is required for the replacement or repair of some mechanical parts or fittings.





**Pros & Cons:**



- + The excreta of one user are flushed away before the next user arrives
- + No real problems with odours if used correctly
- + Suitable for all types of users (sitters, squatters, wipers and washers)
- High capital costs; operating costs depend on the price of water
- Requires a constant source of water
- Cannot be built and/or repaired locally with available materials

**References**

---

- \_ Maki, B. (2005). *Assembling and Installing a New Toilet*. Available: [www.hammerzone.com](http://www.hammerzone.com) (Describes how to install a toilet with full colour photos and step-by-step instructions.)
- \_ Vandervort, D. (2007). *Toilets: Installation and Repair*. HomeTips.com. Available: [http://hometips.com/content/toilets\\_intro.html](http://hometips.com/content/toilets_intro.html) (Describes each part of the toilet in detail as well as providing links to other tools such as how to install a toilet, how to fix a leaking toilet and other toilet essentials.)

**Inputs:**  Urine  Faeces  Flushwater  
 Dry Cleansing Material  Anal Cleansing Water

**Outputs:**  Urine  Brownwater

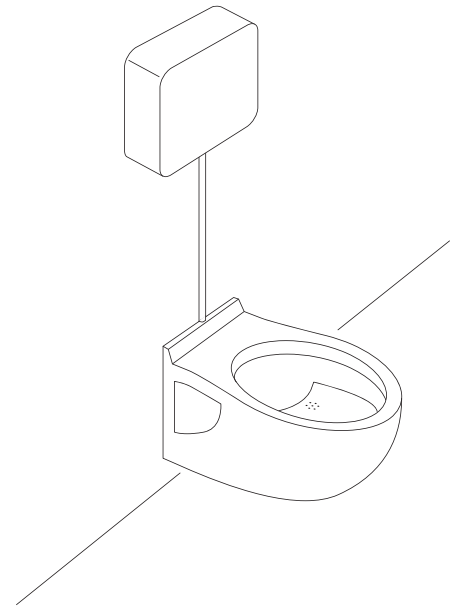
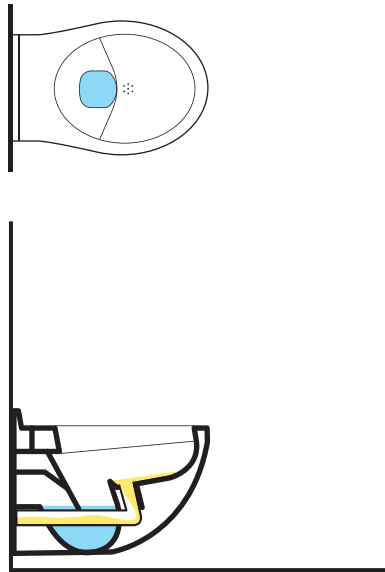

**The Urine Diverting Flush Toilet (UDFT) is similar in appearance to a Cistern Flush Toilet except for the diversion in the bowl. The toilet bowl has two sections so that the urine can be separated from the faeces.**

When the user sits on the toilet, urine is collected in a drain in the front (where there is no water) and faeces are collected in the back (where there is water). The urine is collected without water, but a small amount of water is used to rinse the urine-collection bowl after the user stands up. The urine flows into a storage tank for further use or processing, while the faeces are flushed with water to be treated. The system requires dual plumbing (i.e. plumbing for the urine and for the brownwater).

**Adequacy** The toilet should be installed carefully with an understanding of how and where clogs may occur so that they can be easily removed.

A UDFT is adequate when there is a limited supply of water for flushing, a treatment technology for the brownwater (i.e. faeces, dry cleansing material and flushing water) and a use for the collected urine.

To improve diversion efficiency, Urinals for men are recommended.

UDFTs are suitable for public and private applications although significant education and awareness is required in public settings to ensure proper use and to minimize clogging.

This technology requires dual plumbing (separate for urine and brownwater), which is more complicated than plumbing for Cistern Flush Toilets.

**Health Aspects/Acceptance** Information cards and/or diagrams are essential for ensuring proper use and for promoting acceptance; if users understand why the urine is being separated they will be more willing to use the UDFT properly. Proper plumbing will ensure that there are no odours.

**Maintenance** As with any toilet, proper cleaning is important to keep the bowl(s) clean and prevent organic residues and stains from forming.

Because urine is collected separately, calcium- and magnesium-based minerals can precipitate out and build up in the fittings and pipes. Washing the bowl with a mild acid and/or hot water can prevent the build-up

of mineral deposits; stronger (>24% acetic) acid or a caustic soda solution (2 parts water to 1 part soda) can be used for removing blockages however, some manual removal may be required periodically.

To limit scaling, all connections (pipes) to storage tanks should be kept as short as possible; whenever they exist, pipes should be installed with at least a 1% slope and sharp (90°) angles should be avoided. Larger diameter pipes (75 mm for low maintenance and 50 mm for higher maintenance) should be used.

#### **Pros & Cons:**

- + Requires less water than a traditional Flush Toilet
- + No real problems with odours if used correctly
- + Looks like, and can be used almost like, a Cistern Flush Toilet
- Limited availability; can not be built or repaired locally
- High capital and low to moderate operating costs (depending on parts and maintenance)
- Labour-intensive maintenance
- The toilet is not intuitive; requires education and acceptance to be used correctly
- Is prone to clogging and misuse
- Requires a constant source of water
- Men usually require a separate Urinal for optimum collection of urine.

#### **References**

---



- \_ GTZ (1999). *Technical data sheets for ecosan components: Urine diversion Toilets*. GTZ, Germany.  
Available: [www.gtz.de](http://www.gtz.de)  
(Provides a thorough comparison of the Flush Toilets with Urine diversion currently on the market. Information includes contact information and pricing as well as a description of the installation and maintenance requirements.)
- \_ Kvarnström, E., et al. (2006). *Urine Diversion – One step towards sustainable sanitation. Report 2006-1*. Ecosan Res: Ecosan Publication Series, Stockholm.  
Available: [www.ecosanres.org](http://www.ecosanres.org)

This section describes the technologies that collect and store the intermediate products that are generated at the User Interface. Some of the technologies presented herein are designed specifically for treatment, while others are designed specifically for collection and storage, although they provide some degree of treatment depending on the storage time.







<b>Application Level</b> (★★) Household (★★) Neighbourhood (★) City	<b>Management Level</b> (★★) Household (★★) Shared (★★) Public	<b>Inputs:</b>  Urine
		<b>Outputs:</b>  Stored Urine

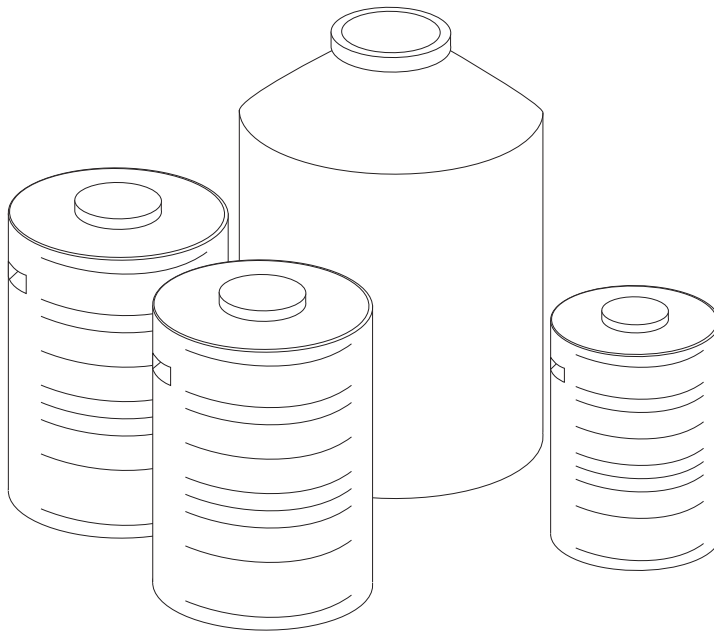

**When urine cannot be used immediately or transported using a Conveyance Technology (i.e. Jerrycans) it can be stored onsite in containers or tanks. The Storage Tank must then be moved or emptied into another container for transport.**

The Storage Tank should be appropriately sized to accommodate the number of users and the time required to sanitise the urine. The storage guidelines for urine correspond to the temperature of storage and the intended crop, but all urine should be stored for at least 1 month (see WHO guidelines for specific storage and application guidelines). Smaller volume Storage Tanks can be used and transported to another, centralized Storage Tank at, or close to, the point of use (i.e. the farm).

Mobile Storage Tanks should be plastic or fibreglass, but permanent Storage Tanks can be made of concrete or plastic. Metal should be avoided as it can be easily corroded by the high pH of stored urine.

With storage time, a layer of organic sludge and precipitated minerals (primarily calcium and magnesium phosphates) will form on the bottom of the tank. Any tank used for urine storage should have an

opening large enough so that it can be cleaned and/or pumped out.

Neither the Storage Tank, nor the collection pipes should be ventilated, but they both need to be pressure equalized. If the Storage Tank is emptied using a vacuum truck, the inflow of air must be maintained at a sufficient rate to ensure that the tank does not implode due to the vacuum.

If the Storage Tank is connected to the toilet or urinal directly with a pipe, care should be taken to minimize the length of the pipe since precipitates will accumulate. If pipes must be used, they should have a steep slope (greater than 1% slope), no sharp angles, large diameters (up to 110 mm for underground pipes) and be easily removable in case of blockages.

To minimize odours, the tank should be filled from the bottom, i.e. the urine should flow down through a pipe and be released near the bottom of the tank; this will prevent the urine from spraying as well as prevent back-flow.

**Adequacy** Long-term storage is the best way to sanitize urine without the addition of chemicals or mechanical processes.

Urine Storage Tanks can be used in virtually every environment; tanks should be well-sealed to prevent leaks, infiltration and evaporation. Urine Storage Tanks can be installed indoors, outdoors, above ground and below ground depending on the climate, space available, and soil.

**Health Aspects/Acceptance** The risk of disease transmission from stored urine is low. Extended storage with storage times greater than 6 months provides near complete sanitation.

**Maintenance** A viscous sludge will accumulate on the bottom of the Storage Tank. When the Storage Tank is emptied, the sludge will usually be emptied along with the urine, but if a tap is used and the tank is never fully emptied, it may require desludging. The desludging period will depend on the composition of the urine and the storage conditions.

Mineral and salt build-up in the tank or on connecting pipes can be manually removed (sometimes with difficulty) or can be dissolved with a strong acid (24% acetic).

**Pros & Cons:**

- + Can be built and repaired with locally available materials
- + No electrical energy required
- + Can be used immediately
- + Small land area required
- + Low capital and operating costs
- Mild to strong odour when opening and emptying tank (depending on storage conditions)

**References**

---

- \_ GTZ (2007). *Technical data sheet, urine diversion: Piping and storage*. GTZ, Germany.  
Available: [www.gtz.de](http://www.gtz.de)
- \_ Kvarnström, E., et al. (2006). *Urine Diversion - One step towards sustainable sanitation. Report 2006-1*. Ecosan Res: Ecosan Publication Series, Stockholm.  
Available: [www.ecosanres.org](http://www.ecosanres.org)
- \_ WHO (2006). *Guidelines for the safe use of wastewater, excreta and greywater- Volume 4: Excreta and greywater use in agriculture*. WHO, Geneva.  
Available: [www.who.int](http://www.who.int)

**Application Level**

- ★★ Household
- ★ Neighbourhood
- City

**Management Level**

- ★★ Household
- ★★ Shared
- Public

**Inputs:** Excreta Faeces  
Anal Cleansing Water

**Outputs:** Excreta Faecal Sludge

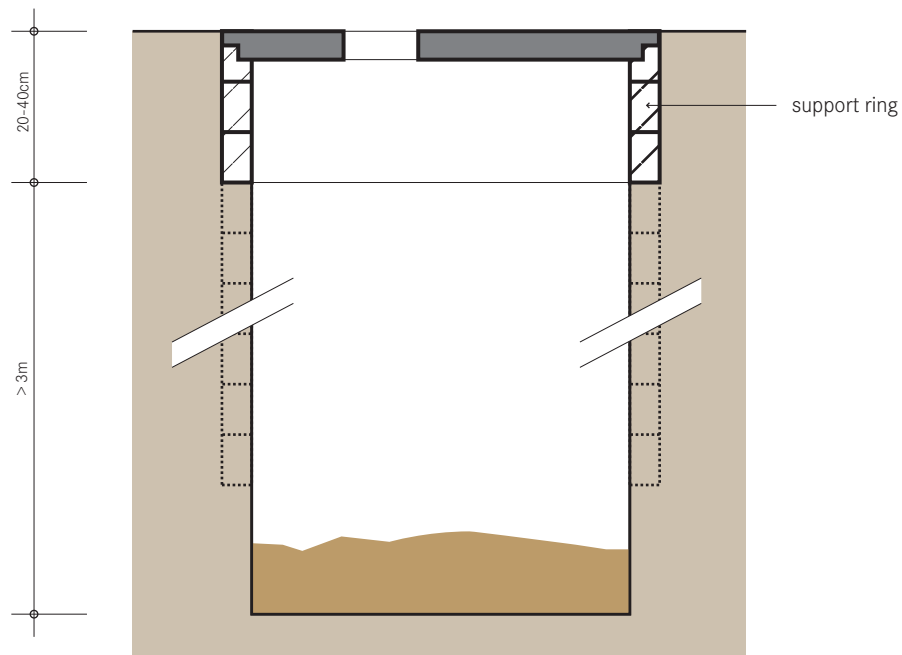

**The Single Pit is one of the most widely used sanitation technologies. Excreta, along with anal cleansing materials (water or solids) are deposited into a pit. Lining the pit prevents it from collapsing and provides support to the superstructure.**

As the Single Pit fills, two processes limit the rate of accumulation: leaching and degradation. Urine and anal cleansing water percolate into the soil through the bottom of the pit and wall while microbial action degrades part of the organic fraction.

On average, solids accumulate at a rate of 40 to 60L per person/year and up to 90L per person/year if dry cleansing materials such as leaves, newspapers, and toilet paper are used. The volume of the pit should be designed to contain at least 1,000L. Ideally the pit should be designed to be at least 3m deep and 1 m in diameter. If the pit diameter exceeds 1.5m there is an increased risk of collapse. Depending on how deep they are dug, some pits may last up to 20 years without emptying. If the pit is to be reused it should be lined. Pit lining materials can include brick, rot-resistant timber, concrete, stones, or mortar plastered onto the soil. If the soil is stable (i.e. no presence of sand or gravel de-

posits or loose organic materials), the whole pit need not be lined. The bottom of the pit should remain unlined to allow the infiltration of liquids out of the pit.

As the effluent leaches from the Single Pit and migrates through the unsaturated soil matrix, faecal organisms are removed. The degree of faecal organism removal varies with soil type, distance travelled, moisture and other environmental factors and thus, it is difficult to estimate the necessary distance between a pit and a water source. A distance of 30m between the pit and a water source is recommended to limit exposure to chemical and biological contamination.

When it is impossible or difficult to dig a deep pit, the depth of the pit can be extending by building the pit upwards with the use of concrete rings or blocks. This adaptation is sometimes referred to as a cesspit. It is a raised shaft on top of a shallow pit with an open bottom that allows for the collection of faecal sludge and the leaching of effluent. This design however, is prone to improper emptying since it may be easier to break or remove the concrete rings and allow the faecal sludge to flow out rather than have it emptied and disposed of properly.

Another variation is the unlined shallow pit that may be appropriate for areas where digging is difficult. When the shallow pit is full, it can be covered with leaves and soil and a small tree can be planted. This concept is called the Arborloo and is a successful way of avoiding costly emptying, while containing excreta, and reforesting an area. The Arborloo is discussed in more detail on the D1: Fill and Cover/Arborloo Technology Information Sheet.

**Adequacy** Treatment processes in the Single Pit (aerobic, anaerobic, dehydration, composting or otherwise) are limited and therefore, pathogen reduction and organic degradation is not significant. However, since the excreta are contained, pathogen transmission to the user is limited.

Single Pits are appropriate for rural and peri-urban areas; Single Pits in urban or dense areas are often difficult to empty and/or have sufficient space for infiltration.

Single Pits are especially appropriate when water is scarce and where there is a low groundwater table. They are not suited for rocky or compacted soils (that are difficult to dig) or for areas that flood frequently.

**Health Aspects/Acceptance** A simple Single Pit is an improvement to open defecation; however, it still poses health risks:

- Leachate can contaminate groundwater;
- Stagnant water in pits may promote insect breeding;
- Pits are susceptible to failure/overflowing during floods.

Single Pits should be constructed at an appropriate distance from homes to minimize fly and odour nuisances and to ensure convenience and safe travel.

**Upgrading** A Ventilated Improved Pit (VIP) is slightly more expensive but greatly reduces the nuisance of flies and odours, while increasing comfort and usability. For more information on the VIP please refer to S3: Single Pit VIP Technology Information Sheet.

When two pits are dug side-by-side, one can be used while the contents of the other pit are allowed to mature for safer emptying. For more information on dual pit technologies refer to S4: Double Pit VIP and S6: Twin Pits for Pour Flush Technology Information Sheets.

**Maintenance** There is no daily maintenance associated with a simple Single Pit. However, when the pit is full it can be a) pumped out and reused or b) the superstructure and squatting plate can be moved to a new pit and the previous pit covered and decommissioned.

#### Pros & Cons:

- + Can be built and repaired with locally available materials
- + Does not require a constant source of water
- + Can be used immediately after construction
- + Low (but variable) capital costs depending on materials
- Flies and odours are normally noticeable
- Sludge requires secondary treatment and/or appropriate discharge
- Costs to empty may be significant compared to capital costs
- Low reduction in BOD and pathogens

#### References

- \_ Brandberg, B. (1997). *Latrine Building. A Handbook for Implementation of the Sanplat System*. Intermediate Technology Publications, London.  
(A good summary of common construction problems and how to avoid mistakes.)
- \_ Franceys, R., Pickford, J. and Reed, R. (1992). *A guide to the development of on-site sanitation*. WHO, Geneva.  
(For information on accumulation rates, infiltration rates, general construction and example design calculations.)
- \_ Lewis, JW., et al. (1982). *The Risk of Groundwater Pollution by on-site Sanitation in Developing Countries*. International Reference Centre for Waste Disposal, Dübendorf, Switzerland.  
(Detailed study regarding the transport and die-off of microorganisms and implications for locating technologies.)
- \_ Morgan, P. (2007). *Toilets That Make Compost: Low-cost, sanitary toilets that produce valuable compost for crops in an African context*. Stockholm Environment Institute, Sweden.  
(Describes how to build a support ring/foundation.)
- \_ Pickford, J. (1995). *Low Cost Sanitation. A Survey of Practical Experience*. Intermediate Technology Publications, London.  
(Information on how to calculate pit size and technology life.)

## S.3 Single Ventilated Improved Pit (VIP)

Applicable to:  
**System 1**

S.3

### Application Level

- ★★ Household
- ★ Neighbourhood
- City

### Management Level

- ★★ Household
- ★★ Shared
- ★ Public

**Inputs:** Excreta Faeces  
Anal Cleansing Water

**Outputs:** Faecal Sludge

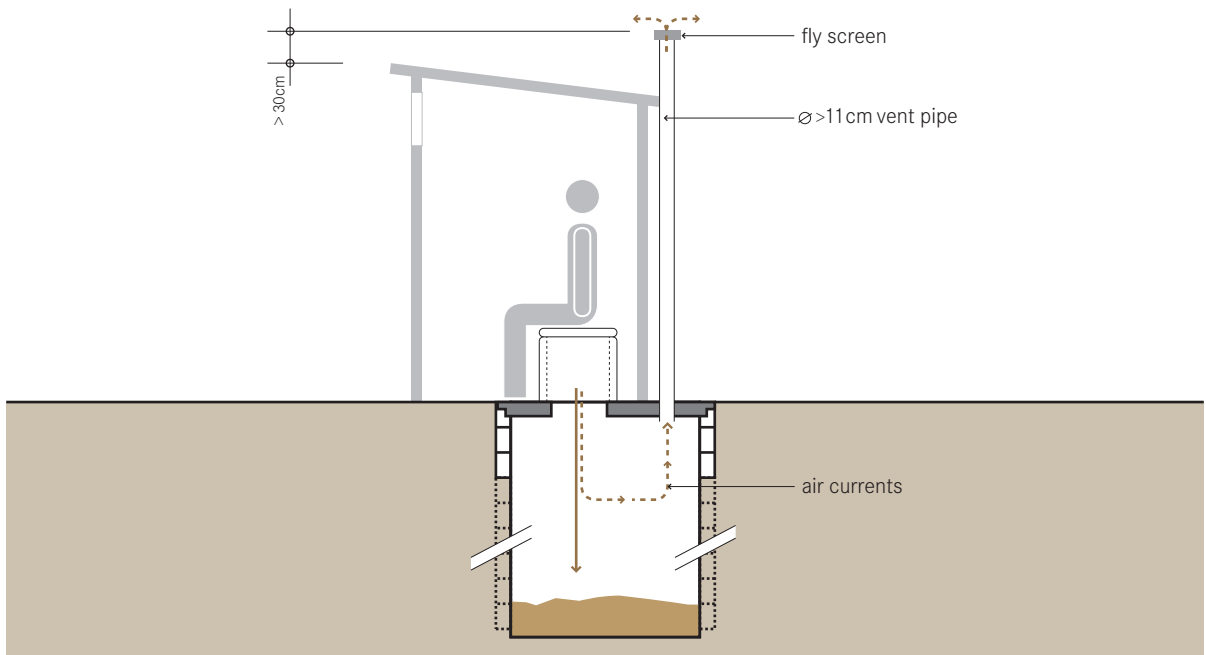

**The Single VIP is a Ventilated, Improved Pit. It is an improvement over the Single Pit because continuous airflow through the ventilation pipe vents odours and acts as a trap for flies as they escape towards the light.**

Despite their simplicity, well-designed Single VIPs can be completely smell free, and be more pleasant to use than some other water-based technologies.

Flies that hatch in the pit are attracted to the light at the top of the ventilation pipe. When they fly towards the light and try to escape they are trapped by the fly-screen and die. The ventilation also allows odours to escape and minimizes the attraction for flies.

The vent pipe should have an internal diameter of at least 110mm to a maximum of 150mm and reach more than 300mm above the highest point of the toilet superstructure. The vent works better in windy areas but where there is little wind, its effectiveness can be improved by painting the pipe black; the heat difference between the pit (cool) and the vent (warm) creates an updraft that pulls the air and odours up and out of the pit. To test the efficacy of the ventilation, a small, smoky fire can be lit in the pit; the smoke should be pulled up and out of the vent pipe and not remain in the pit or the superstructure.

The mesh size of the fly screen must be large enough to prevent clogging with dust and allow air to circulate freely. Aluminium screens, with a hole-size of 1.2 to 1.5 mm have proven to be the most effective.

The top diameter of the Single VIP should be between 1 to 1.5m and be dug at least 3m deep, although the deeper the better. Deep pits can last up to 15, 20, 30 or more years.

As the effluent leaches from the Single VIP and migrates through unsaturated soils, faecal organisms are removed. The degree of faecal organism removal varies with soil type, distance travelled, moisture and other environmental factors and thus, it is difficult to estimate the necessary distance between a pit and a water source. A minimum distance of 30m between the pit and a water source is recommended to limit exposure to chemical and biological contamination.

**Adequacy** Treatment processes in the Single VIP (aerobic, anaerobic, dehydration, composting or otherwise) are limited, and therefore, pathogen reduction and organic degradation is not significant. However, since the excreta are contained, pathogen transmission to the user is limited. This technology is a significant improvement over Single Pits or open defecation.

Single VIPs are appropriate for rural and peri-urban areas; single pits in urban or dense areas are often difficult to empty and/or have insufficient space for infiltration. Depending on the pit depth, depth to the water table, number of users and soil conditions, some pits can be used for 20 years without emptying.

VIPs are especially appropriate when water is scarce and where there is a low groundwater table. They should be located in an area with a good breeze. They are not suited for rocky or compacted soils (that are difficult to dig) or for areas that flood frequently.

**Health Aspects/Acceptance** A Single VIP can be a very clean, comfortable, and well accepted sanitation option. However some health concerns exist:

- Latrine leachate can contaminate groundwater;
- Pits are susceptible to failure/overflowing during floods;
- Health risks from flies are not completely removed by ventilation.

**Upgrading** A Single VIP toilet can be upgraded to a Double VIP, a Urine Diverting Dry Toilet (UDDT) if there is a use for urine, or a water-based Pour Flush Toilet if water is available. A Double VIP has the addition of an extra pit so that while one pit is in use, the contents of the full pit are draining, maturing and undergoing degradation. Pathogens are destroyed much more thoroughly in a Double VIP and therefore, the contents are less hazardous to remove from the pit, although because the contents are so solid, the contents cannot be pumped, but rather, must be manually emptied.

**Maintenance** To keep the Single VIP free of flies and odours, regular cleaning and maintenance is required. Dead flies, spider webs, dust and other debris should be removed from the ventilation screen to ensure a good flow of air.

**Pros & Cons:**

- + Flies and odours are significantly reduced (compared to non-ventilated pits)
- + Does not require a constant source of water
- + Suitable for all types of user (sitters, squatters, washers and wipers)

- + Can be built and repaired with locally available materials
- + Can be used immediately after construction
- + Low (but variable) capital costs depending on materials and pit depth
- + Small land area required
- Sludge requires secondary treatment and/or appropriate discharge
- Costs to empty may be significant compared to capital costs
- Low reduction in BOD and pathogens

**References**

- Mara, D.D. (1996). *Low-Cost Urban Sanitation*. Wiley, Chichester, UK. (Provides detailed design information.)
  - Mara D.D. (1984). *The Design of Ventilated Improved Pit Latrines (UNDP Interreg. Project INT/81/047)*. The World Bank + UNDP, Washington.
  - Morgan, P.R. (1977). *The Pit Latrine – Revived*. *Central African Journal of Medicine*, 23(1).
  - Morgan, P.R. (1979). *A Ventilated Pit Privy*. *Appropriate Technology*, 6 (3).
  - Morgan P.R. and Mara, D.D. (1982). *Ventilated Improved Pit Latrines: Recent Developments in Zimbabwe*. World Bank Technical Paper no.3. Available: [www.worldbank.org](http://www.worldbank.org)
  - Morgan P.R. (1990). *Rural Water Supplies and Sanitation*. Blair Research Laboratory & Ministry of Health + MacMillan, Harare, Zimbabwe.
- General Information:
- Franceys, R., Pickford, J. and Reed, R. (1992). *A guide to the development of on-site sanitation*. WHO, Geneva.
  - Lewis, J.W., et al. (1982). *The Risk of Groundwater Pollution by on-site Sanitation in Developing Countries*. International Reference Centre for Waste Disposal, Dübendorf, Switzerland. (A detailed study regarding the transport and die-off of microorganisms and implications for locating technologies.)
  - The World Bank (1986). *Information and Training for Low-Cost Water Supply and Sanitation (UNDP Project INT/82/002)*. The World Bank, Washington.

Application Level	Management Level	Inputs:
<ul style="list-style-type: none"> <li>★★ Household</li> <li>★ Neighbourhood</li> <li>□ City</li> </ul>	<ul style="list-style-type: none"> <li>★★ Household</li> <li>★★ Shared</li> <li>★ Public</li> </ul>	<ul style="list-style-type: none"> <li>Excreta</li> <li>Faeces</li> <li>Anal Cleansing Water</li> </ul>
		<b>Outputs:</b> Compost/EcoHumus

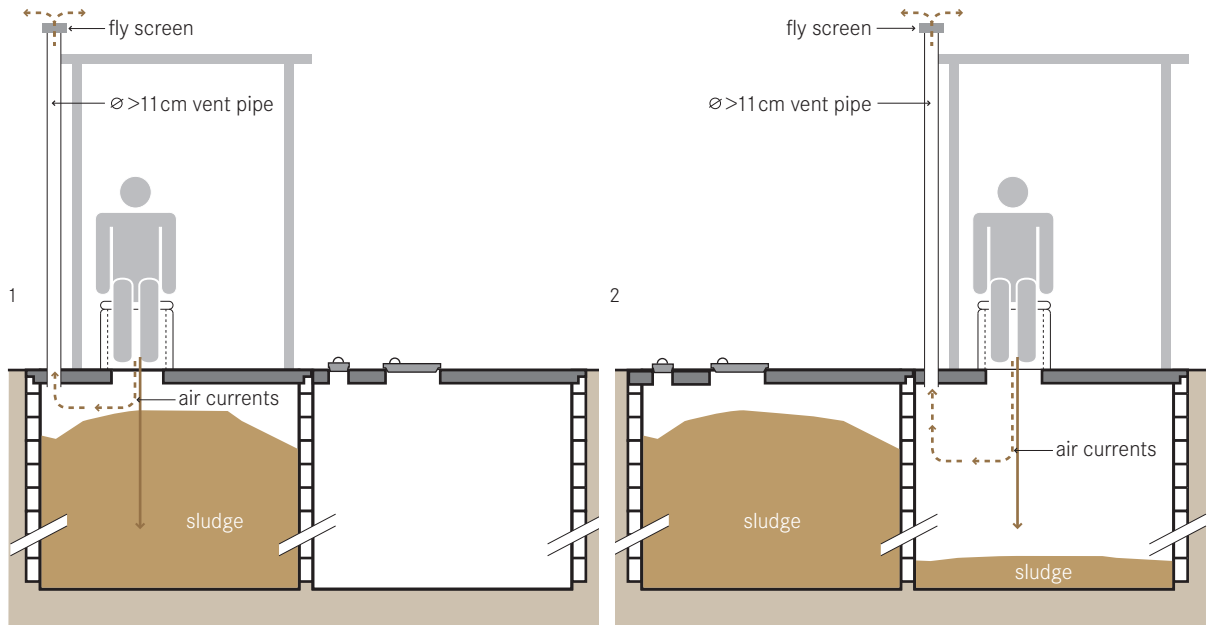

**The Double VIP has almost the same design as the Single VIP (S3) with the added advantage of a second pit that allows the technology to be used continuously and allows for safer and easier emptying.**

By using two pits, one pit can be used while the contents of the second pit rests, drains, reduces in volume, and degrades. When the second pit is almost full (the excreta is 50cm from the top of the pit), it is covered, and the contents of the first pit are removed. Due to the extended resting time (at least 1 year of filling/resting) the material within the pit should be sanitized and humus-like. The Double VIP is similar to the Fossa Alterna (S5) technology with the exception that the Fossa Alterna is specifically designed to produce humus and as such, it requires regular additions of soil, ash and/or leaves.

The superstructure may either extend over both holes or it may be designed to move from one pit to the other. In either case, the pit that is not being filled should be fully covered and sealed to prevent water, garbage and animals (and/or people) from falling into the pit. The ventilation of the two pits can be accomplished using one ventilation pipe moved back and forth between the pits or each pit can be equipped with its own dedicated

pipe. The two pits in the Double VIP are continually used and should be well lined and supported to ensure longevity.

**Adequacy** The Double VIP is more appropriate than the Single VIP for denser, peri-urban areas. The material is manually emptied (it is dug out, not pumped out), so vacuum truck access to the pits is not necessary. The users can remove the pit material after a sufficient resting time of one or more years even though the treatment processes in the pit are not complete and the material is not entirely hygienic. The Double VIP technology will only work properly if the two pits are used sequentially and not concurrently. Therefore, an adequate cover for the out of service pit is required. Double VIPs are especially appropriate when water is scarce and where there is a low groundwater table. They should be located in an area with a good breeze. They are not suited for rocky or compacted soils (that are difficult to dig) or for areas that flood frequently.

**Health Aspects/Acceptance** The Double VIP can be a very clean, comfortable and well accepted sanitation option, in some cases even more so than a water-



based technology. However some health concerns exist:

- Latrine leachate can contaminate groundwater;
- Pits are susceptible to failure/overflowing during floods; and
- Health risks from flies are not completely removed by ventilation.

**Maintenance** To keep the Double VIP free of flies and odours, regular cleaning and maintenance is required. Dead flies, spider webs, dust and other debris should be removed from the ventilation screen to ensure a good flow of air. The out of service pit should be well sealed to reduce water infiltration and a proper alternating schedule must be maintained.

**Pros & Cons:**

- + Longer life than Single VIP (indefinite if maintained)
- + Potential for use of stored faecal material as soil conditioner
- + Flies and odours are significantly reduced (compared to non-ventilated pits)
- + Does not require a constant source of water
- + Suitable for all types of user (sitters, squatters, washers and wipers)
- + Can be built and repaired with locally available materials
- + Can be used immediately after construction
- + Small land area required
- Low/moderate reduction in pathogens
- Higher capital cost than Single VIP; reduced operating costs if self-emptied

**References**

---

- \_ Mara DD. (1984). *The Design of Ventilated Improved Pit Latrines (UNDP Interreg. Project INT/81/047)*. The World Bank+ UNDP, Washington. (A good reference for detailed Double Pit VIP design information.)
  - \_ Mara, DD. (1996). *Low-Cost Urban Sanitation*. Wiley, Chichester, UK. (General description of VIPs with a focus on the ventilation system.)
- General Information:
- \_ Franceys, R., Pickford, J. and Reed, R. (1992). *A guide to the development of on-site sanitation*. WHO, Geneva.
  - \_ Lewis, JW., et al. (1982). *The Risk of Groundwater Pollution by on-site Sanitation in Developing Countries*. International Reference Centre for Waste Disposal, Dübendorf, Switzerland. (Detailed study regarding the transport and die-off of microorganisms and implications for locating technologies.)
  - \_ The World Bank (1986). *Information and Training for Low-Cost Water Supply and Sanitation (UNDP Project INT/82/002)*. The World Bank, Washington.

<b>Application Level</b> (★★) Household (★) Neighbourhood ( ) City	<b>Management Level</b> (★★) Household (★★) Shared (★) Public	<b>Inputs:</b> Excreta (brown square), Organics (green square) Anal Cleansing Water (yellow square)
		<b>Outputs:</b> Compost/EcoHumus (green square)

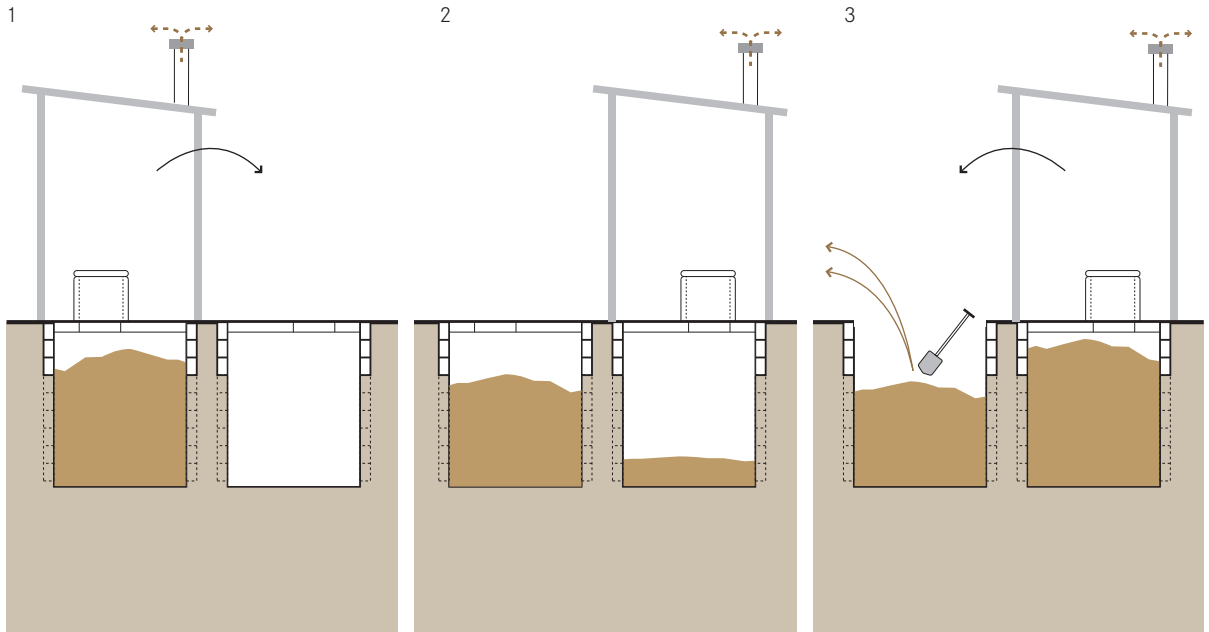

**The Fossa Alterna is an alternating, waterless (dry) double pit technology. Compared to the Double VIP which is just designed to collect, store and partially treat excreta, the Fossa Alterna is designed to make EcoHumus. The Fossa Alterna is dug to a maximum depth of 1.5 m and requires a constant input of soil.**

One of the Fossa Alterna pits should fill over a period of 12–24 months depending on the size of the pit and the number of users. The full pit degrades during the period of time that the second pit is filling, which, ideally, should take one year. The material in the full pit will degrade into a dry, earth-like mixture that can be easily removed manually.

Soil, ash, and/or leaves should be added to the pit after defecation (not urination). The soil and leaves introduce a variety of organisms like worms, fungi and bacteria which help in the degradation process. Also, the pore space is increased, which allows for anaerobic conditions. Additionally, the ash helps to control flies, reduce odours and make the mix slightly more alkaline.

The Fossa Alterna should be used for urine, but water should not be added (small amounts of anal cleansing water can be tolerated). Water encourages the develop-

ment of vectors and pathogens but it also fills the pore-spaces and deprives the aerobic bacteria of the oxygen that is required for degradation. The choice of User Interface will determine the material that enters the pit. Since bulking material is used to continuously cover the excreta, smells are reduced but the addition of a ventilation pipe can reduce the smells even further.

The Fossa Alterna pits are relatively shallow with a depth of 1.5m. Even though the pits are shallow, this should be more than enough space to accommodate a family of 6 for one year. To optimize the space, the material that mounds in the centre of the pit (underneath the toilet) should be pushed to the sides periodically. Unlike a simple or ventilated pit which will be covered or emptied, the material in the Fossa Alterna is meant to be reused. Therefore, it is extremely important that no garbage is put into the pit as it will reduce the quality of the material recovered, and may even make it unusable.

Emptying the Fossa Alterna is easier than emptying other pits: the pits are shallower and the addition of soil means that the material is less compact. The material that is removed is not offensive and presents a reduced threat of contamination.

**Adequacy** The Fossa Alterna is appropriate for rural and peri-urban areas. It is especially adapted to water-scarce environments. It is a useful solution for areas that have poor soil and could benefit from the composted humic material as a soil amendment. A constant source of soil, ash and/or leaves is required.

The Fossa Alterna is not appropriate for greywater as the pit is shallow and the conditions must remain aerobic for degradation. Another greywater treatment system must be used in parallel. A UDDT can be used with the Fossa Alterna, but only in circumstances when the soil cannot sufficiently absorb the urine or when urine is highly valued for application.

The material is manually emptied from the Fossa Alterna (it is dug out, not pumped out), so vacuum truck access to the pits is not necessary.

The Fossa Alterna technology will only work properly if the two pits are used sequentially and not concurrently. Therefore, an adequate cover for the out of service pit is required.

The Fossa Alterna is especially appropriate when water is scarce. It is not suited for rocky or compacted soils (that are difficult to dig) or for areas that flood frequently.

**Health Aspects/Acceptance** By covering faeces with soil/ash, flies and odours are kept to a minimum. Users may not understand the difference between the Fossa Alterna and a Double VIP, although if given the opportunity to use one, people should have a good appreciation of the advantages. Demonstration units can be used to show how easily one can empty a Fossa Alterna in comparison to emptying a Double Pit. Keeping the contents sealed in the pit for the duration of at least one year makes the material safer and easy to handle. The same precautions that are taken when handling compost should be taken with the humus derived from the Fossa Alterna.

**Maintenance** When the first pit is put into use, a layer of leaves should be put into the bottom of the pit.

Periodically, more leaves should be added to increase the porosity and oxygen availability. Following the addition of faeces to the pit, a small amount of soil or ash should be added. To lengthen the filling time of the pit soil is not added to the pit following urination. Occasionally, the mounded material beneath the toilet hole should be pushed to the sides of the pit for an even distribution of materials.

Depending on the dimensions of the pits, materials should be emptied every year.

#### **Pros & Cons:**

- + Can be built and repaired with locally available materials
- + Because double pits are used alternately, their life is virtually unlimited
- + Excavation of humus is easier than faecal sludge
- + Potential for use of stored faecal material as soil conditioner
- + Flies and odours are significantly reduced (compared to non-ventilated pits)
- + Does not require a constant source of water
- + Suitable for all types of user (sitters, squatters, washers and wipers)
- + Low (but variable) capital costs depending on materials; no or low operating costs if self-emptied
- + Small land area required
- + Significant reduction in pathogens
- Requires constant source of cover material (soil, ash, leaves, etc.)
- Garbage may ruin reuse opportunities of Compost/EcoHumus

#### **References**

- 
- Morgan, P. (2007) *Toilets That Make Compost: Low-cost, sanitary toilets that produce valuable compost for crops in an African context*. Stockholm Environment Institute, Sweden. Available: [www.ecosanres.org](http://www.ecosanres.org) (Step-by-step guide for building a Fossa Alterna.)

<b>Application Level</b> (★★) Household (★) Neighbourhood ( ) City	<b>Management Level</b> (★★) Household (★★) Shared (★) Public	<b>Inputs:</b> ( ) Blackwater ( ) Greywater ( ) Anal Cleansing Water
		<b>Outputs:</b> ( ) Compost/EcoHumus

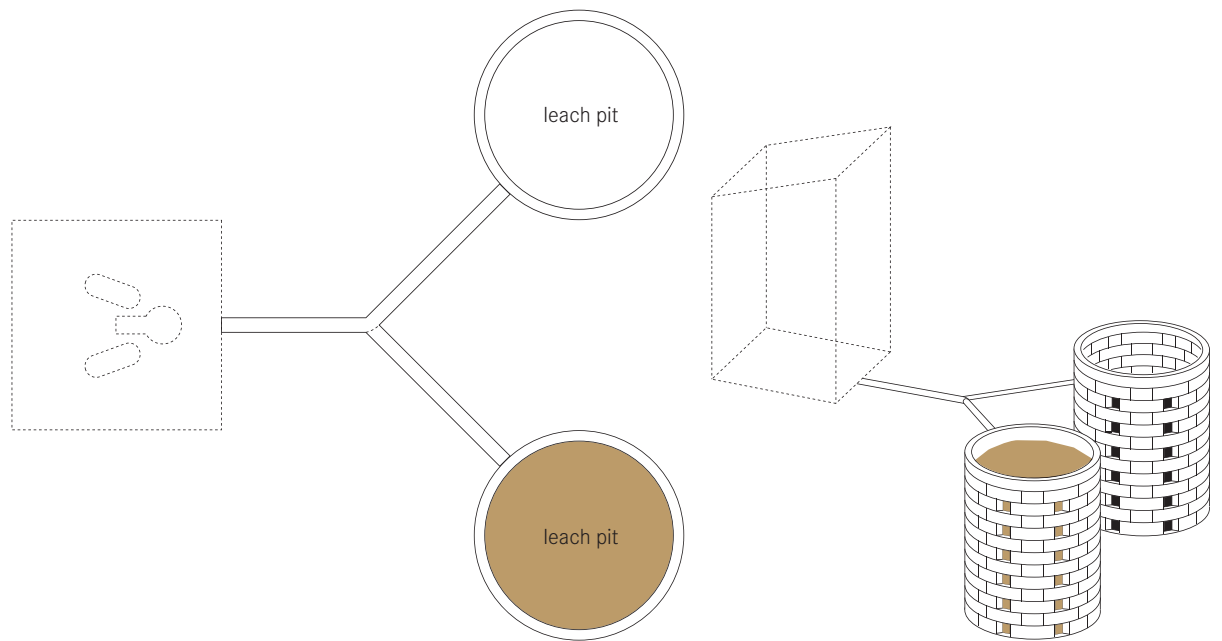

**This technology consists of two alternating pits connected to a Pour Flush Toilet. The blackwater (and greywater) is collected in the pits and allowed to slowly infiltrate into the surrounding soil. With time, the solids are sufficiently dewatered and can be manually removed with a shovel.**

The superstructure, toilet and pits, for the Twin Pits with Pour Flush technology can be designed in various ways: the toilet can be located directly over the pits or at a distance from the pits. The superstructure can be permanently constructed over both pits or it can move from side to side depending on which pit is in use. No matter how the system is designed, only one pit is used at a time. In this way, a continuous cycle of alternating pits means that they can be used indefinitely.

While one pit is filling with excreta, cleansing water and flushing water, the other full pit is resting. The pits should be an adequate size to accommodate a volume of waste generated over one or two years. This allows the contents of the full pit enough time to transform into a safe, inoffensive, soil-like material that can be excavated manually. The difference between this technology and the Double VIP or Fossa Alterna is that it

allows for the addition of water and does not include the addition of soil or organic material. As this is a water-based (wet) technology, the full pits require a longer retention time to degrade the material before it can be excavated safely. A retention time of 2 years is recommended. The degraded material is too solid to be removed with a vacuum truck.

As the effluent leaches from the pit and migrates through an unsaturated soil matrix, faecal organisms are removed. The degree of faecal organism removal varies with soil type, distance travelled, moisture and other environmental factors. There is a risk of groundwater pollution whenever there is a high or variable water table, fissures and/or cracks in the bedrock. Viruses and bacteria can travel hundreds of metres in saturated conditions. As soil and groundwater properties are often unknown, it is difficult to estimate the necessary distance between a pit and a water source. A minimum distance of 30m should be maintained between the pit and a water source to limit exposure to chemical and biological contamination.

It is recommended that the Twin Pits be constructed 1 m apart from each other to minimize cross-contamination between the maturing pit and the one in use. It

is also recommended that the pits be constructed over 1 m from any structural foundation as leachate can negatively impact structural supports.

Water within the pit can impact the structural stability of the pit. Therefore, all walls should be lined up to the full depth of the pit to prevent collapse and the top 30 cm should be fully mortared to prevent direct infiltration and ensure that the superstructure is supported.

**Adequacy** The Twin Pits with Pour Flush is a permanent technology that is appropriate for areas where it is not appropriate to continuously move a pit latrine. It is a water-based technology and is only appropriate where there is a constant supply of water for flushing (e.g. recycled greywater or rainwater). Greywater can be co-managed along with the blackwater in the twin pits.

This technology is not appropriate for areas with a high groundwater table or areas that are frequently flooded. In order for the pits to drain properly, the soil must have a good absorptive capacity; clay, tightly packed or rocky soils are not appropriate.

As long as water is available, the Twin Pits with Pour Flush technology is appropriate for almost every type of housing density. However, too many wet pits in a small area is not recommended as there may not be sufficient capacity to absorb the liquid into the soil matrix from all of the pits and the ground may become water-logged (oversaturated).

The material is manually emptied from the Twin Pits (it is dug out, not pumped out), so vacuum truck access to the pits is not necessary.

The Twin Pits with Pour Flush technology will only work properly if the two pits are used sequentially and not concurrently. Therefore, an adequate cover for the out of service pit is required.

**Health Aspects/Acceptance** The waterseal provides a high level of comfort and cleanliness, with few odours. It is a commonly accepted sanitation option, however some health concerns exist:

- Latrine leachate can contaminate groundwater;
- Stagnant water in pits may promote insect breeding;
- Pits are susceptible to failure/overflowing during floods.

**Maintenance** The pits must be emptied regularly and care must be taken to ensure that they do not flood during rainy seasons. After a recommended two year resting time, the pits should be emptied manually using long handled shovels and proper personal protection. If the pits are self-emptied there are no operational costs except for any replacements to the structure or slab in the event of damage.

#### Pros & Cons

- + Can be built and repaired with locally available materials
- + Because double pits are used alternately, their life is virtually unlimited
- + Excavation of humus is easier than faecal sludge
- + Potential for use of stored faecal material as soil conditioner
- + Flies and odours are significantly reduced (compared to pits without a waterseal)
- + Low (but variable) capital costs depending on materials; no or low operating costs if self-emptied
- + Moderate reduction in pathogens
- Excreta require manual removal
- Clogging is frequent when bulky cleansing materials are used

#### References

##### Detailed Design information:

- Roy, A.K., et al. (1984). *Manual on the Design, Construction and Maintenance of Low-Cost Pour Flush Waterseal Latrines in India*. (UNDP Interreg. Project INT/81/047). The World Bank + UNDP, Washington.

##### General Information:

- Franceys, R., Pickford, J. and Reed, R. (1992). *A guide to the development of on-site sanitation*. WHO, Geneva.
- Mara, D.D. (1996). *Low-Cost Urban Sanitation*. Wiley, Chichester, UK.
- The World Bank (1986). *Information and Training for Low-Cost Water Supply and Sanitation*. (UNDP Project INT/82/002). The World Bank, Washington.

<b>Application Level</b> (★★) Household (★) Neighbourhood (□) City	<b>Management Level</b> (★★) Household (★★) Shared (★) Public	<b>Inputs:</b> <span style="display:inline-block; width:10px; height:10px; background-color: #8B4513; border: 1px solid black;"></span> Faeces
		<b>Outputs:</b> <span style="display:inline-block; width:10px; height:10px; background-color: #8B4513; border: 1px solid black;"></span> Dried Faeces

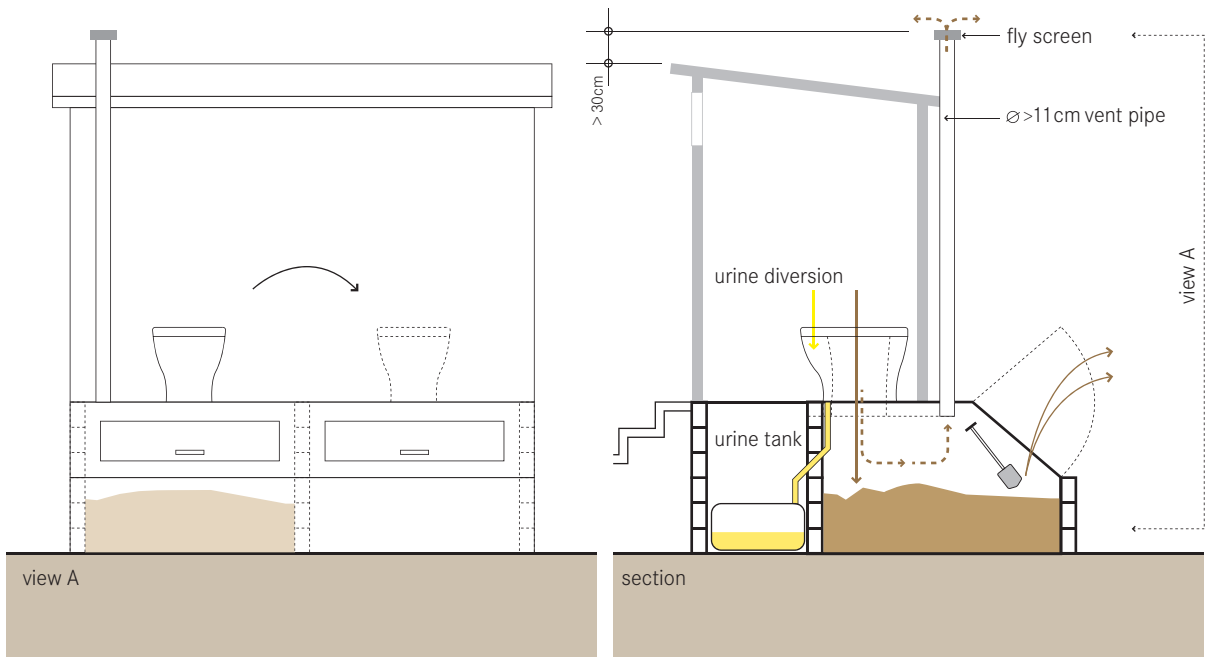

**Dehydration vaults are used to collect, store and dry (dehydrate) faeces. Faeces will only dehydrate when the vaults are watertight to prevent external moisture from entering and when urine and anal cleansing water are diverted away from the vaults.**

When urine is separated from faeces, the faeces dry quickly. In the absence of moisture, organisms cannot grow and as such, smells are minimized and pathogens are destroyed. Vaults used for drying faeces in the absence of urine have various local names. One of the most common names for this technology is the Vietnamese Double Vaults.

A family of 6 will produce 500L of faeces in approximately six months. For design purposes it is recommended to assume that one person will require almost 100L of faeces storage space every six months. The vaults should be slightly oversized to account for airflow, visitors and the non-even distribution of faeces in the chamber. Each vault is sized to accommodate six months of faeces accumulation which in turn, results in a six month drying time in the out-of-service vault.

Two alternating vaults allow the faeces to dehydrate in one vault while the other vault fills. When one vault is full

it is sealed with a lid and the UDDT (U2) is moved to the second vault. While the second vault fills up, the faeces in the first vault slowly dry and decrease in volume. When the second vault is full, it is sealed, the dry material from the first vault is removed and the first vault is then put back into service.

The vaults must be watertight to keep the faeces as dry as possible. Chambers should be constructed of sealed block or formed concrete to ensure that rainwater, surface run-off, greywater and urine are prevented from entering the vaults. Urine can be collected in a bucket and discharge to the ground (garden) or stored in a tank for future transport and use.

A vent is required to help keep the vaults dry and control flies and odours.

**Adequacy** Dehydration Vaults can be installed in almost every setting from rural to dense urban because of the small land area required, the minimal odours and the ease of use. They are especially appropriate for water scarce and rocky areas. In areas that are frequently flooded, Dehydration Vaults are appropriate because they are constructed to be watertight. Furthermore, where there is no plot of land available, the vaults

can be installed indoors, which also makes this technology applicable for colder climates (where leaving the house is less desirable).

**Health Aspects/Acceptance** Dehydration Vaults can be a clean, comfortable, and easy-to-use technology. When users are well educated and understand how the technology works they may be more willing to accept it as a viable sanitation solution.

When the vaults are kept dry, there should be no problems with flies or odours. Faeces from the double vaults should be very dry and relatively safe to handle provided they were continuously covered with material and not allowed to get wet.

There is a low health risk for those whom have to empty or change the urine container. Faeces that have been dried for over one year also pose a low health risk.

**Upgrading** There is a risk however when using single vaults, that the top portion of the faeces will not be fully dried and/or hygienized. Single vaults are not recommended (because of the need to handle fresh faeces) and should, whenever possible be upgraded to a double vault.

**Maintenance** To prevent flies, minimize odours and encourage drying, a small amount of ash, soil, or lime should be used to cover faeces after each use. Care should be taken to ensure that no water or urine gets into the Dehydration Vault. If this happens, extra soil, ash, lime, or sawdust can be added to help absorb the liquid.

Because the faeces are not actually degraded (just dried), dry cleansing materials must not be added to the Dehydration Vaults as they will not decompose. Occasionally, the mounded faeces beneath the toilet hole should be pushed to the sides of the pit for an even drying.

Where water is used for cleansing, an appropriate User Interface should be installed to divert and collect it separately. To empty the vaults, a shovel, gloves and possibly a face mask (cloth) should be used to limit contact with the dried faeces.

#### Pros & Cons:

- + Can be built and repaired with locally available materials
- + Because double pits are used alternately, their life is virtually unlimited
- + Good in rocky and/or flooded areas
- + Excavation of dried faeces is easier than faecal sludge
- + No real problems with flies or odours if used correctly
- + Does not require a constant source of water
- + Suitable for all types of user (sitters, squatters, washers and wipers)
- + Low (but variable) capital costs depending on materials; no or low operating costs
- + Small land area required
- Requires education and acceptance to be used correctly
- Requires constant source of ash, sand or lime
- Requires a use/discharge point for urine and faeces
- Urine and faeces require manual removal

#### References

- \_ (-) *Manual del Sanitario Ecologico Seco*. Available: [www.zoomzap.com](http://www.zoomzap.com)  
(A very comprehensive manual on dry chamber construction including detailed instruction and material lists. In Spanish.)
- \_ GTZ (2005). *Urine diverting dry toilets programme dissemination (data sheet)*. GTZ, Germany. Available: [www.gtz.de](http://www.gtz.de)  
(General overview of Dehydration Chambers with some dimensioning and materials lists.)
- \_ Winblad, U., and Simpson-Herbert, M. (eds.) (2004). *Ecological Sanitation - revised and enlarged edition*. SEI, Stockholm, Sweden.  
(A general description of various designs and adaptations, especially Chapter 3.)
- \_ Women in Europe for a Common Future (2006). *Urine diverting Toilets: Principles, Operation and Construction*. Available: [www.wecf.de](http://www.wecf.de)  
(Photos and explanation of how to build a double vault and superstructure.)

<b>Application Level</b> <input checked="" type="checkbox"/> Household <input checked="" type="checkbox"/> Neighbourhood <input type="checkbox"/> City	<b>Management Level</b> <input checked="" type="checkbox"/> Household <input checked="" type="checkbox"/> Shared <input checked="" type="checkbox"/> Public	<b>Inputs:</b> <input type="checkbox"/> Organics <input type="checkbox"/> Excreta
		<b>Outputs:</b> <input type="checkbox"/> Compost/EcoHumus

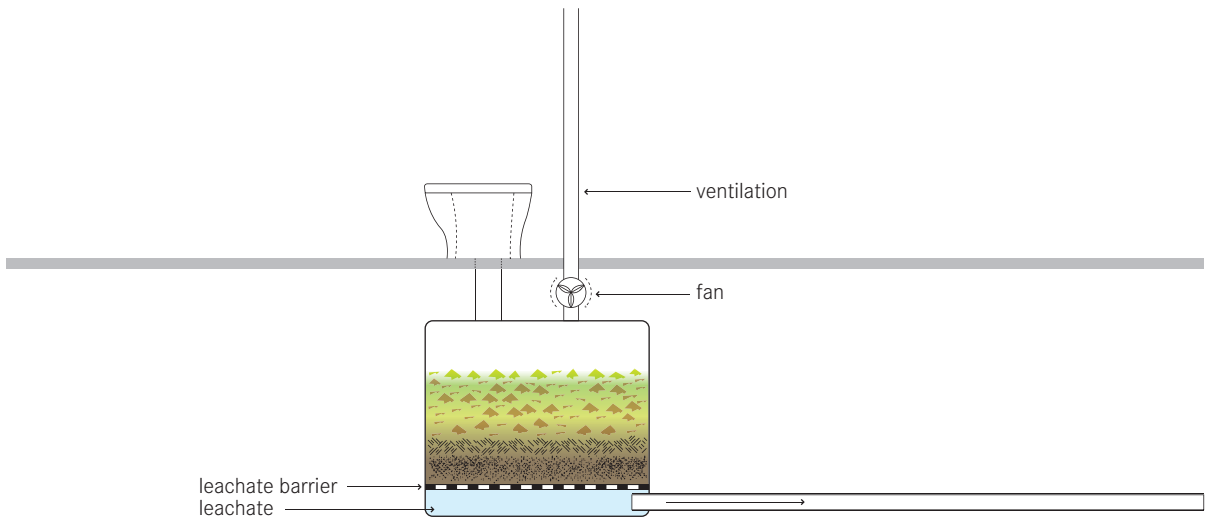

**Composting refers to the process by which biodegradable components are biologically decomposed under aerobic conditions by microorganisms (mainly bacteria and fungi). A Composting Chamber converts excreta and organics into Compost. Compost is a stable, inoffensive product that can be handled safely and used as a soil conditioner.**

This technology usually requires four main parts:

- 1) a reactor (storage chamber);
- 2) a ventilation unit to provide oxygen and allow gases (CO<sub>2</sub>, water vapour) to escape;
- 3) a leachate collection system ; and
- 4) an access door to remove the mature product.

A Composting Chamber can be designed in various configurations and constructed above or below ground. UDDT can be used as a User Interface for specifically designed Composting Chambers. Anal Cleansing Water should not be added to the composting chamber as it could cause anaerobic conditions, foul smells and reduced collection capacity.

There are four factors that will ensure the good functioning of the system:

- a) sufficient air (oxygen), provided by active aeration (pumped air) or passive aeration;
- b) proper moisture (ideally moisture content should be between 45–70%);
- c) internal (heap) temperature of 40–50° C (can be controlled with proper chamber dimensioning); and
- d) a 25:1 carbon to nitrogen ratio (theoretically) which can be adjusted by adding an external source of carbon such as toilet paper, wood chips, and/or vegetable scraps.

It is appropriate to assume a design value of 300L/person/year to calculate the required chamber volume.

**Adequacy** Although simple in theory, Composting Chambers are not always easy to operate. The moisture must be controlled to prevent anaerobic conditions, the ratio of carbon and nitrogen must be well balanced and the volume of the unit must be such that the temperature of the compost pile remains between 40 to 50° C. However, once the composting process is well established, the system is quite robust.

Depending on the design, Composting Chambers can be used indoors with the comfort and convenience of a flush toilet.



This technology is appropriate to almost all areas, but since it is compact and waterless, it is especially suited to warm climates and to areas where land and water are limited. In colder climates, a Composting Chamber can also be used indoors to ensure that low temperatures do not impede the composting process. A Composting Chamber cannot be used for the Collection and Storage/Treatment of anal cleansing water or greywater; if the reactor becomes too wet, anaerobic conditions will form and there will be problems with odour and improper degradation.

**Health Aspects/Acceptance** If the Composting Chamber is well designed and constructed, there should be no reason for the users to handle the material for at least the first year, and thus, little opportunity to come in contact with pathogens.

A well functioning Composting Chamber should not produce odours, and should be easy to maintain. If there is ample cover/bulking material there should not be problems with flies or insects.

**Upgrading** A simple Composting Chamber can be upgraded to include a small ventilation fan, a mechanical mixer, or multiple compartments to allow for increased storage and degradation time.

**Maintenance** Depending on the design, the Composting Chamber should be emptied every 2 to 10 years. Only the completely mature compost should be removed. With time, salt or other solids may build up in the tank or in the leachate-collecting system, which can be dissolved with hot water and/or scraped out.

A squeeze test can be used to check the moisture level within the Composting Chamber. A squeeze test requires the user to squeeze a handful of compost. The compost should not crumble and feel dry, nor should it feel like a wet sponge. Rather, the compost should only leave a few drops of water in the user's hand.

#### Pros & Cons:

- + The compost that is removed is safe to handle and can be used as a soil conditioner
- + Can help reduce the volume of solid waste generated by diverting organic material into the composting unit
- + Can be built and repaired with locally available materials
- + Long service life
- + No real problems with flies or odours if used correctly
- + Low-moderate capital costs depending on emptying; low operating costs
- + High reduction of pathogens
- + Does not require constant source of water
- Leachate requires secondary treatment and/or appropriate discharge
- Requires expert design and construction supervision
- May require some specialized parts
- May require long start up time

#### References

- Del Porto, D. and Steinfeld, C. (1999). *The Composting Toilet System Book. A Practical Guide to Choosing, Planning and Maintaining Composting Toilet Systems, a Water-Saving, Pollution-Preventing Alternative*. The Center for Ecological Pollution Prevention (CEPP), Concord, Massachusetts. (Comprehensive installation and maintenance for pre-fabricated units.)
- Drescher, S., Zurbrügg, C., Enayetullah, I. and Singha, MAD. (2006). *Decentralised Composting for Cities of Low- and Middle-Income Countries – A User's Manual*. Eawag/Sandec and Waste Concern, Dhaka. Available: [www.sandec.ch](http://www.sandec.ch)
- Jenkins, J. (1999). *The Humanure Handbook-2nd Edition*. Jenkins Publishing, Grove City, PA, USA. Available: [www.jenkinspublishing.com](http://www.jenkinspublishing.com) (Theory, history, and do-it-yourself guide to composting toilets.)
- USEPA (1999). *Water Efficiency Technology Fact Sheet: Composting Toilets- EPA 832-F-99-066*. US Environmental Protection Agency, Washington. Available: [www.epa.gov/owm/mtb/comp.pdf](http://www.epa.gov/owm/mtb/comp.pdf) (Information related to microbial die off rates and risks.)

## S.9 Septic Tank

Applicable to:  
**System 5, 6**

S.9

### Application Level

- ★★ Household
- ★★ Neighbourhood
- City

### Management Level

- ★★ Household
- ★★ Shared
- ★★ Public

**Inputs:**  Blackwater  Greywater

**Outputs:**  Faecal Sludge  Effluent

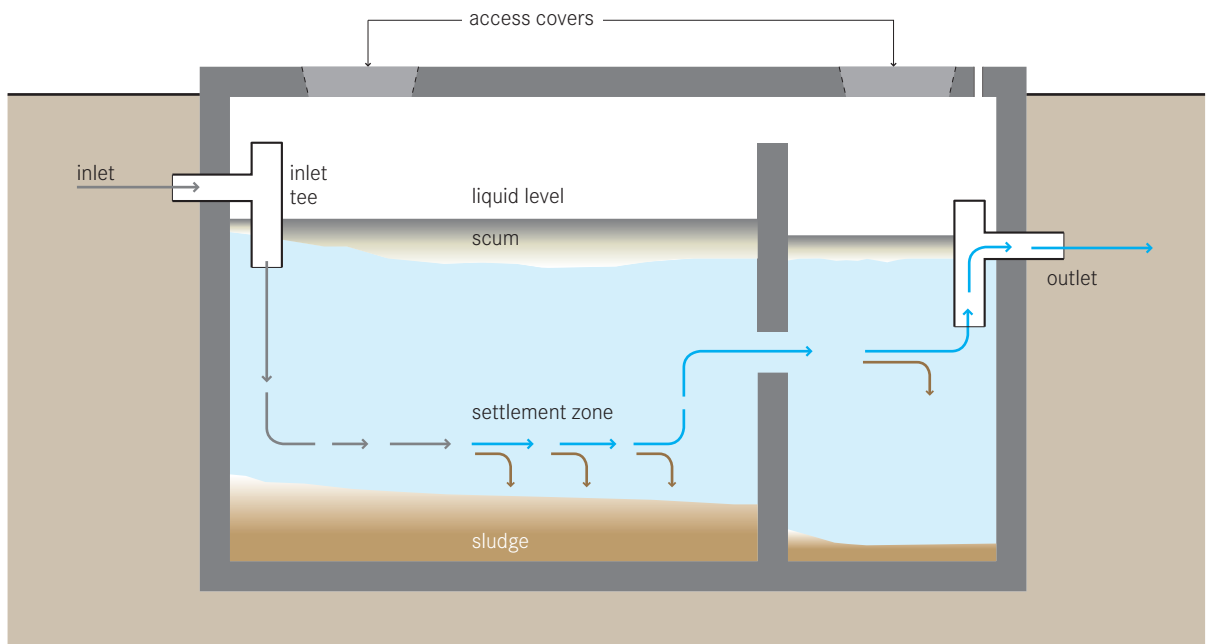

**A Septic Tank is a watertight chamber made of concrete, fibreglass, PVC or plastic, for the storage and treatment of blackwater and greywater. Settling and anaerobic processes reduce solids and organics, but the treatment is only moderate.**

A Septic Tank should typically have at least two chambers. The first chamber should be at least 50% of the total length and when there are only two chambers, it should be 2/3 of the total length. Most of the solids settle out in the first chamber. The baffle, or the separation between the chambers, is to prevent scum and solids from escaping with the effluent. A T-shaped outlet pipe will further reduce the scum and solids that are discharged.

Liquid flows into the tank and heavy particles sink to the bottom, while scum (oil and fat) floats to the top. With time, the solids that settle to the bottom are degraded anaerobically. However, the rate of accumulation is faster than the rate of decomposition, and the accumulated sludge must be removed at some point. Generally, Septic Tanks should be emptied every 2 to 5 years, although they should be checked yearly to ensure proper functioning.

The design of a Septic Tank depends on the number of users, the amount of water used per capita, the average annual temperature, the pumping frequency and the characteristics of the wastewater. The retention time should be designed for 48 hours to achieve moderate treatment.

A variation of the Septic Tank is called an aquaprivy, which is a simple storage and settling tank located directly below the toilet, so that the excreta fall into the tank. To prevent odours from surfacing, a waterseal must be maintained but it may not completely prevent smells and the tank must be frequently desludged.

The effluent must be dispersed by using a Soak Pit (D6) or Leach Field (D7) or by transporting the effluent to another treatment technology via a Simplified Sewer (C4) or Solids-Free (C5).

**Adequacy** A Septic Tank is appropriate where there is a way of dispersing or transporting the effluent.

Because the Septic Tank must be desludged regularly, a vacuum truck should be able to access the location. Often Septic Tanks are installed in the home, under the kitchen or bathroom which makes emptying difficult.

If Septic Tanks are used in densely populated areas,

onsite infiltration should not be used otherwise the ground will become oversaturated and excreta may rise up to the surface posing a serious health risk. Instead, the Septic Tank should be connected to a sewer and the effluent should be transported to a subsequent treatment or disposal site. Larger, multi-chamber Septic Tanks can be designed for groups of houses and/or public buildings (i.e. schools).

Generally, the removal of 50% of solids, 30 to 40% of biochemical oxygen demand (BOD) and a 1-log removal of *E.coli* can be expected in a well designed Septic Tank although efficiencies vary greatly depending on operation and maintenance and climactic conditions.

Septic Tanks can be installed in every type of climate although the efficiency will be affected in colder climates. Even though the Septic Tank is watertight, it should not be constructed in areas with high groundwater tables or where there is frequent flooding.

Aquaprivies can be built indoors and above ground and are appropriate for rocky or flood-prone areas where pits or other technologies would not be appropriate. However, because they require frequent emptying and constant maintenance, they are only recommended for very specific applications.

**Health Aspects/Acceptance** Although the removal of pathogens is not high, the entire tank is below the surface so users do not come in contact with any of the wastewater.

Users should be careful when opening the tank because noxious and flammable gases may be released. Septic Tanks should have a vent.

A vacuum truck should be used to empty the sludge from the Septic Tank. Users should not attempt to empty the pit themselves except with a manual technology like the Gulper (C2).

**Upgrading** A Septic Tank that is connected to a Leach Field (D7) or a Soak Pit (D6) can later be connected to a Solids-Free Sewer (C5) if/when one is installed.

**Maintenance** Septic Tanks should be checked to ensure that they are watertight and the levels of the

scum and sludge should be monitored to ensure that the tank is functioning well. Because of the delicate ecology, care should be taken not to discharge harsh chemicals into the Septic Tank.

The sludge should be removed annually using a vacuum truck to ensure proper functioning of the Septic Tank.

#### **Pros & Cons:**

- + Can be built and repaired with locally available materials
- + Long service life
- + No real problems with flies or odours if used correctly
- + Low capital costs, moderate operating costs depending on water and emptying
- + Small land area required
- + No electrical energy required
- Low reduction in pathogens, solids and organics
- Effluent and sludge require secondary treatment and/or appropriate discharge
- Requires constant source of water

#### **References**

##### Detailed Design Information:

- Mara, D.D. (1996). *Low-Cost Urban Sanitation*. Wiley, Chichester, UK.  
(Sizing, volume and emptying calculations and example design solutions, Chapter 6.)
- Polprasert, C. and Rajput, V.S. (1982). *Environmental Sanitation Reviews: Septic Tank and Septic Systems*. Environmental Sanitation Information Center, Bangkok, AIT, Thailand. pp 68–74. (Comprehensive design manual)
- Sasse, L. (1998). *DEWATS. Decentralised Wastewater Treatment in Developing Countries*. BORDA, Bremen Overseas Research and Development Association, Bremen, Germany.  
(Excel® Spreadsheet codes for sizing septic tanks.)

##### General Information:

- Crites, R. and Tchobanoglous, G. (1998). *Small and Decentralized Wastewater Management Systems*. WCB and McGraw-Hill, New York, USA.

<b>Application Level</b> (★★) Household (★★) Neighbourhood ( ) City	<b>Management Level</b> (★★) Household (★★) Shared (★★) Public	<b>Inputs:</b> ( ) Blackwater ( ) Greywater
		<b>Outputs:</b> ( ) Faecal Sludge ( ) Effluent

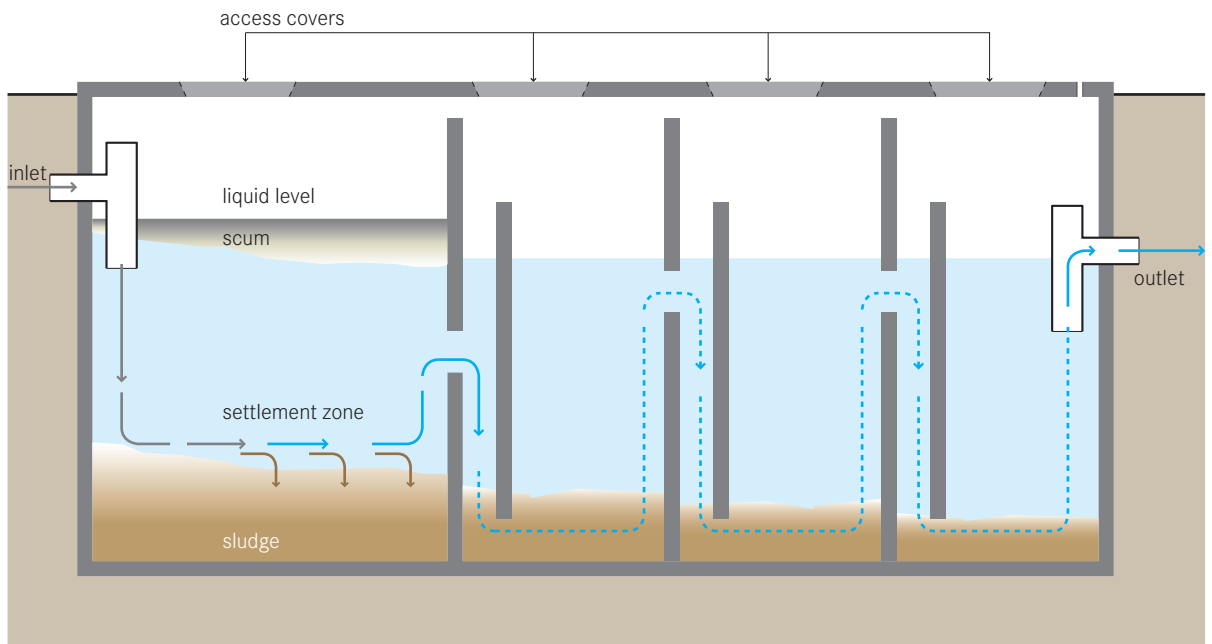

**An Anaerobic Baffled Reactor (ABR) is an improved septic tank because of the series of baffles under which the wastewater is forced to flow. The increased contact time with the active biomass (sludge) results in improved treatment.**

The majority of settleable solids are removed in the sedimentation chamber at the beginning of the ABR, which typically represents 50% of the total volume. The up-flow chambers provide additional removal and digestion of organic matter: BOD may be reduced by up to 90%, which is far superior to that of a conventional septic tank. As sludge is accumulating, desludging is required every 2 to 3 years. Critical design parameters include a hydraulic retention time (HRT) between 48 to 72 hours, up-flow velocity of the wastewater less than 0.6 m/h and the number of up-flow chambers (2 to 3).

**Adequacy** This technology is easily adaptable and can be applied at the household level or for a small neighbourhood (refer to Technology Information Sheet T1: Anaerobic Baffled Reactor for information about applying an Anaerobic Baffled Reactor at the community level).

An ABR can be designed for a single house or a group of houses that are using a considerable amount of water for clothes washing, showering, and toilet flushing. It is mostly appropriate if water use and supply of wastewater are relatively constant.

This technology is also appropriate for areas where land may be limited since the tank is installed underground and requires a small area. It should not be installed where there is a high groundwater table as infiltration will affect the treatment efficiency and contaminate the groundwater.

Typical inflows range from 2,000 to 200,000L/day. The ABR will not operate at full capacity for several months after installation because of the long start up time required for the anaerobic digestion of the sludge. Therefore, the ABR technology should not be used when the need for a treatment system is immediate. To help the ABR to start working more quickly, it can be 'seeded', i.e. active sludge can be introduced so that active bacteria can begin working and multiplying immediately. Because the ABR must be emptied regularly, a vacuum truck should be able to access the location. ABRs can be installed in every type of climate although the efficiency will be affected in colder climates.

**Health Aspects/Acceptance** Although the removal of pathogens is not high, the ABR is contained so users do not come in contact with any of the wastewater or disease causing pathogens. Effluent and sludge must be handled with care as they contain high levels of pathogenic organisms.

To prevent the release of potentially harmful gases, the tank should be vented.

**Maintenance** ABR tanks should be checked to ensure that they are watertight and the levels of the scum and sludge should be monitored to ensure that the tank is functioning well. Because of the delicate ecology, care should be taken not to discharge harsh chemicals into the ABR.

The sludge should be removed annually using a vacuum truck to ensure proper functioning of the ABR.

**Pros & Cons:**

- + Resistant to organic and hydraulic shock loads
- + No electrical energy required
- + Greywater can be managed concurrently
- + Can be built and repaired with locally available materials
- + Long service life
- + No real problems with flies or odours if used correctly
- + High reduction of organics
- + Moderate capital costs, moderate operating costs depending on emptying; can be low cost depending on number of users
- Requires constant source of water
- Effluent requires secondary treatment and/or appropriate discharge
- Low reduction pathogens
- Requires expert design and construction
- Pre-treatment is required to prevent clogging

**References**

---

- \_ Bachmann, A., Beard, V.L. and McCarty, P.L. (1985). Performance Characteristics of the Anaerobic Baffled Reactor. *Water Research* 19 (1): 99-106.
- \_ Foxon, K.M., Pillay, S., Lalbahadur, T., Rodda, N., Holder, F. and Buckley, CA. (2004). The anaerobic baffled reactor (ABR): An appropriate technology for on-site sanitation. *Water SA* 30 (5) (Special edition). Available: [www.wrc.org.za](http://www.wrc.org.za)
- \_ Sasse, L. (1998). *DEWATS: Decentralised Wastewater Treatment in Developing Countries*. BORDA, Bremen Overseas Research and Development Association, Bremen, Germany. (Design summary including and Excel-based design program.)

<b>Application Level</b> (★★) Household (★★) Neighbourhood ( ) City	<b>Management Level</b> (★★) Household (★★) Shared (★★) Public	<b>Inputs:</b> ( ) Blackwater ( ) Greywater
		<b>Outputs:</b> ( ) Faecal Sludge ( ) Effluent

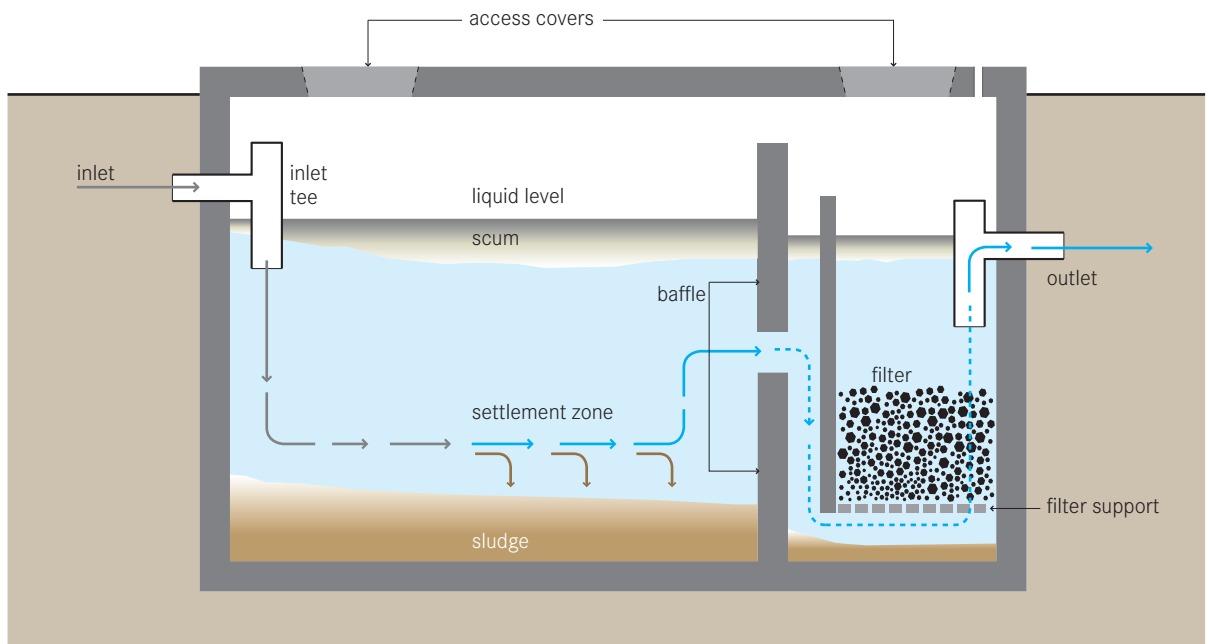

**An Anaerobic Filter is a fixed-bed biological reactor. As wastewater flows through the filter, particles are trapped and organic matter is degraded by the biomass that is attached to the filter material.**

This technology consists of a sedimentation tank (or septic tank) followed by one or more filter chambers. Filter material commonly used includes gravel, crushed rocks, cinder, or specially formed plastic pieces. Typical filter material sizes range from 12 to 55 mm in diameter. Ideally, the material will provide between 90 to 300m<sup>2</sup> of surface area per 1 m<sup>3</sup> of reactor volume. By providing a large surface area for the bacterial mass, there is increased contact between the organic matter and the active biomass that effectively degrades it.

The Anaerobic Filter can be operated in either upflow or downflow mode. The upflow mode is recommended because there is less risk that the fixed biomass will be washed out. The water level should cover the filter media by at least 0.3m to guarantee an even flow regime.

Studies have shown that the HRT is the most important design parameter influencing filter performance. An HRT of 0.5 to 1.5 days is a typical and recommended.

A maximum surface-loading (i.e. flow per area) rate of 2.8m/d has proven to be suitable. Suspended solids and BOD removal can be as high as 85% to 90% but is typically between 50% and 80%. Nitrogen removal is limited and normally does not exceed 15% in terms of total nitrogen (TN).

**Adequacy** This technology is easily adaptable and can be applied at the household level or a small neighbourhood (refer to Technology Information Sheet T2: Anaerobic Filter for information about applying an Anaerobic Filter at the community level).

An Anaerobic Filter can be designed for a single house or a group of houses that are using a lot of water for clothes washing, showering, and toilet flushing. It is only appropriate if water use is high, ensuring that the supply of wastewater is constant.

The Anaerobic Filter will not operate at full capacity for six to nine months after installation because of the long start up time required for the anaerobic biomass to stabilize. Therefore, the Anaerobic Filter technology should not be used when the need for a treatment technology is immediate. Once working at full capacity it is a stable technology that requires little attention.

The Anaerobic Filter should be watertight but it should still not be constructed in areas with high groundwater tables or where there is frequent flooding.

Depending on land availability and the hydraulic gradient of the sewer (if applicable), the Anaerobic Filter can be built above or below ground. It can be installed in every type of climate, although the efficiency will be affected in colder climates.

**Health Aspects/Acceptance** Because the Anaerobic Filter unit is underground, users do not come in contact with the influent or effluent. Infectious organisms are not sufficiently removed, so the effluent should be further treated or discharged properly. The effluent, despite treatment, will still have a strong odour and care should be taken to design and locate the facility such that odours do not bother community members.

To prevent the release of potentially harmful gases, the Anaerobic Filters should be vented.

The desludging of the filter is hazardous and appropriate safety precautions should be taken.

**Maintenance** Active bacteria must be added to start up the Anaerobic Filter. The active bacteria can come from sludge from a septic tank that has been sprayed onto the filter material. The flow should be gradually increased over time, and the filter should be working at maximum capacity within six to nine months.

With time, the solids will clog the pores of the filter. As well, the growing bacterial mass will become too thick and will break off and clog pores. A sedimentation tank before the filter is required to prevent the majority of settleable solids from entering the unit. Some clogging increases the ability of the filter to retain solids. When the efficiency of the filter decreases, it must be cleaned. Running the system in reverse mode to dislodge accumulated biomass and particles cleans the filters. Alternatively, the filter material can be removed and cleaned.

#### Pros & Cons:

- + Resistant to organic and hydraulic shock loads
- + No electrical energy required
- + Can be built and repaired with locally available materials
- + Long service life
- + Moderate capital costs, moderate operating costs depending on emptying; can be lowered depending on the number of users
- + High reduction of BOD and solids
- Requires constant source of water
- Effluent requires secondary treatment and/or appropriate discharge
- Low reduction of pathogens and nutrients
- Requires expert design and construction
- Long start up time

#### References

- \_ Morel, A. and Diener, S. (2006). *Greywater Management in Low and Middle-Income Countries, Review of different treatment systems for households or neighbourhoods*. Swiss Federal Institute of Aquatic Science and Technology (Eawag), Dübendorf, Switzerland. (Short summary including case studies, page 28.)
- \_ Polprasert, C. and Rajput, V.S. (1982). *Environmental Sanitation Reviews: Septic Tank and Septic Systems*. Environmental Sanitation Information Center, AIT, Bangkok, Thailand. pp 68-74. (Short design summary.)
- \_ Sasse, L. (1998). *DEWATS: Decentralised Wastewater Treatment in Developing Countries*. BORDA, Bremen Overseas Research and Development Association, Bremen, Germany. (Design summary including Excel-based design program.)
- \_ von Sperlin, M. and de Lemos Chernicharo, CA. (2005). *Biological Wastewater Treatment in Warm Climate Regions. Volume One*. IWA, London. pp 728-804. (Detailed design instructions.)
- \_ Vigneswaran, S., et al. (1986). *Environmental Sanitation Reviews: Anaerobic Wastewater Treatment-Attached growth and Sludge blanket process*. Environmental Sanitation Information Center, AIT Bangkok, Thailand. (Design criteria and diagrams in Chapter 2.)

**Application Level**

- (★★) Household
- (★★) Neighbourhood
- (★★) City

**Management Level**

- (★★) Household
- (★★) Shared
- (★★) Public

**Inputs:**  Faecal Sludge  Organics  
 Blackwater

**Outputs:**  Treated Sludge  Effluent  
 Biogas

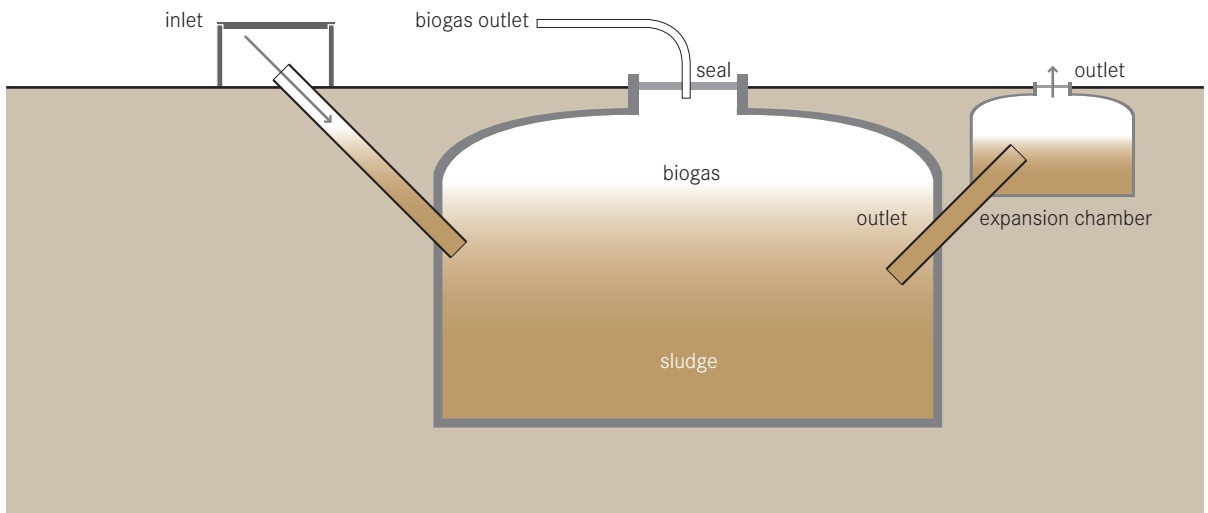

**An Anaerobic Biogas Reactor is an anaerobic treatment technology that produces (a) a digested slurry to be used as a soil amendment and (b) biogas which can be used for energy. Biogas is a mix of methane, carbon dioxide and other trace gasses that can be easily converted to electricity, light and heat.**

An Anaerobic Biogas Reactor is a chamber or vault that facilitates the anaerobic degradation of blackwater, sludge, and/or biodegradable waste. It also facilitates the separation and collection of the biogas that is produced. The tanks can be built above or below ground. Prefabricated tanks or brick-constructed chambers can be built depending on space, resources and the volume of waste generated.

The hydraulic retention time (HRT) in the reactor should be a minimum of 15 days in hot climates and 25 days in temperate climates. For highly pathogenic inputs, a HRT of 60 days should be considered. Normally, Anaerobic Biogas Reactors are not heated, but to ensure pathogen destruction (i.e. a sustained temperature over 50°C) the reactor should be heated (although in practice, this is only found in the most industrialized countries).

Once waste products enter the digestion chamber, gases

are formed through fermentation. The gas forms in the sludge but collects at the top of the reactor, mixing the slurry as it rises. Biogas reactors can be built as fixed dome or floating dome reactors. In the fixed dome reactor the volume of the reactor is constant. As gas is generated it exerts a pressure and displaces the slurry upward into an expansion chamber. When the gas is removed, the slurry will flow back down into the digestion chamber. The pressure generated can be used to transport the biogas through pipes. In a floating dome reactor, the dome will rise and fall with the production and withdrawal of gas. Alternatively, the dome can expand (like a balloon).

Most often biogas reactors are directly connected to indoor (private or public) toilets with an additional access point for organic materials. At the household level, reactors can be made out of plastic containers or bricks and can be built behind the house or buried underground. Sizes can vary from 1,000L for a single family up to 100,000L for institutional or public toilet applications.

The slurry that is produced is rich in organics and nutrients, but almost odourless and partly disinfected (complete pathogen destruction would require thermophilic conditions). Often, a biogas reactor is used as an alter-



native to a conventional septic tank, since it offers a similar level of treatment, but with the added benefit of biogas. Depending on the design and the inputs, the reactor should be emptied once every 6 months to 10 years.

**Adequacy** This technology is easily adaptable and can be applied at the household level or a small neighbourhood (refer to Technology Information Sheet T15: Anaerobic Biogas Reactor for information about applying it at the community level).

Biogas reactors are best used for concentrated products (i.e. rich in organic material). If they are installed for a single household that is using a significant amount of water, the efficiency of the reactor can be improved significantly by also adding animal manure and biodegradable organic waste.

Depending on the soil, location, and size required, the reactor can be built above or below ground (even below roads). For more urban applications, small biogas reactors can be installed on the rooftops or in a courtyard. To minimize distribution losses, the reactors should be installed close to where the gas can be used.

Biogas reactors are less appropriate for colder climates as gas production is not economically feasible below 15°C.

**Health Aspects/Acceptance** The digested slurry is not completely sanitized and still carries a risk of infection. There are also dangers associated with the flammable gases that, if mismanaged, could be harmful to human health.

The Anaerobic Biogas Reactor must be well built and gas tight for safety. If the reactor is properly designed, repairs should be minimal. To start the reactor, active sludge (e.g. from a septic tank) should be used as a seed. The tank is essentially self-mixing, but it should be manually stirred once a week to prevent uneven reactions.

Gas equipment should be cleaned carefully and regularly so that corrosion and leaks are prevented.

Grit and sand that has settled to the bottom should be

removed once every year. Capital costs for gas transmission infrastructure can increase the project cost. Depending on the quality of the output, the gas transmission capital costs can be offset by long-term energy savings.

#### **Pros & Cons:**

- + Generation of a renewable, valuable energy source
- + Low capital costs; low operating costs
- + Underground construction minimizes land use
- + Long life span
- + Can be built and repaired with locally available materials
- + No electrical energy required
- + Small land area required (most of the structure can be built underground)
- Requires expert design and skilled construction
- Gas production below 15°C is not economically feasible
- Digested sludge and effluent still requires treatment

#### **References**

- \_ Food and Agriculture Organization (FAO) (1996). *Biogas Technology: A Training Manual for Extension*. Consolidated Management Services, Kathmandu. Available: [www.fao.org](http://www.fao.org)
- \_ ISAT (1998). *Biogas Digest Vols. I-IV*. ISAT and GTZ, Germany. Available: [www.gtz.de](http://www.gtz.de)
- \_ Koottatep, S., Ompont, M. and Joo Hwa, T. (2004). *Biogas: A GP Option For Community Development*. Asian Productivity Organization, Japan. Available: [www.apo-tokyo.org](http://www.apo-tokyo.org)
- \_ Rose, GD. (1999). *Community-Based Technologies for Domestic Wastewater Treatment and Reuse: options for urban agriculture*. IDRC, Ottawa. pp 29-32. Available: <http://idrinfo.idrc.ca>
- \_ Sasse, L. (1998). *DEWATS: Decentralised Wastewater Treatment in Developing Countries*. BORDA, Bremen Overseas Research and Development Association, Bremen, Germany.

## Conveyance

C

The technologies in this section are responsible for moving or transporting Products from an onsite Collection and Storage/Treatment technology to a subsequent offsite treatment, use or disposal technology.

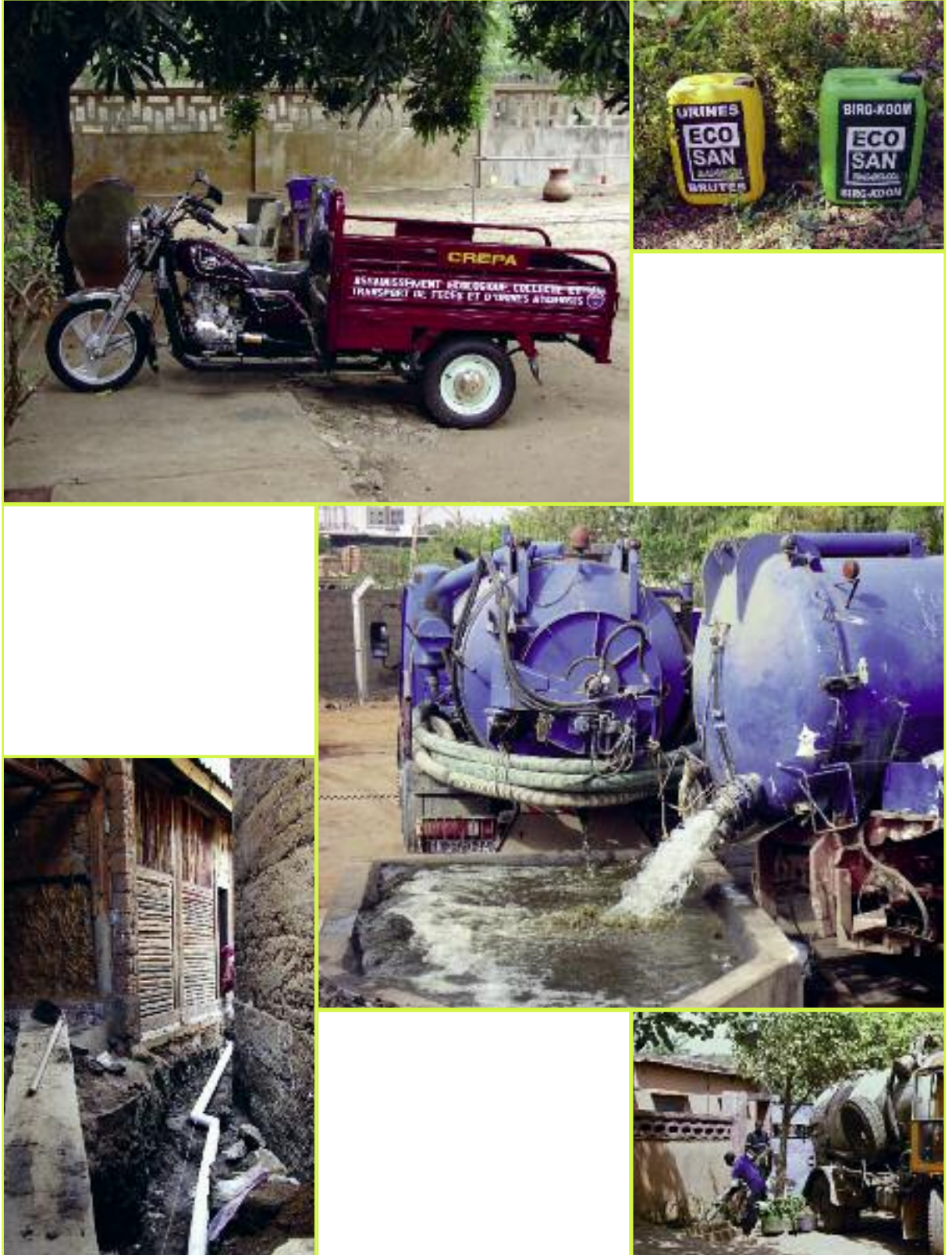



Application Level	Management Level	Inputs/Outputs:
<input checked="" type="checkbox"/> Household <input type="checkbox"/> Neighbourhood <input type="checkbox"/> City	<input checked="" type="checkbox"/> Household <input checked="" type="checkbox"/> Shared <input checked="" type="checkbox"/> Public	<input type="checkbox"/> Urine <input checked="" type="checkbox"/> Stored Urine

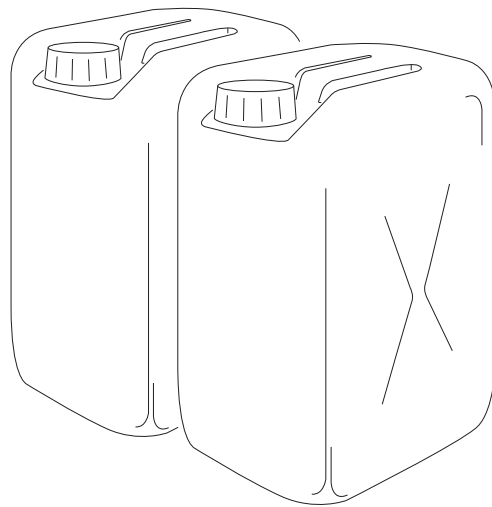

**Jerrycans are light, plastic containers that can be easily carried by one person and are readily available. When sealed, they can be used to store or transport urine easily and without spills. In case separated urine cannot be used near the point of production, it can be transported in a Jerrycan or tank to a central collection/storage facility or to agricultural land for application.**

On average, a person generates 1.5L of urine a day although this quantity may vary significantly depending on the climate and fluid consumption. A family of 5 can be expected to fill a 20L Jerrycan with urine in approximately two days. The urine can then be either stored on site or transported immediately.

For compounds or communities that all have urine diverting systems, it may be more appropriate to have a larger, semi-centralized storage tank that can be transported by other means. Where urine-diversion systems are common, a micro-enterprise may specialize in the collection and transport of Jerrycans using a bicycle, wagon or donkey and cart.

**Adequacy** A well-sealed Jerrycan is an effective way of transporting urine short distances. It is inexpensive, easy to clean and re-useable. This type of transport is only appropriate for areas where the points of generation and use (i.e. home and field) are close together, otherwise a more formalized collection and distribution system is necessary.

Jerrycans can be used in cold environments (where urine freezes) as long as they are not completely filled. Stored frozen urine can be then used in warmer months when it is needed for agriculture.

Because of safety concerns and difficulty with transport, no other liquids (blackwater or greywater) should be transported in Jerrycans

**Health Aspects/Acceptance** There should not be any health risks to those carrying a Jerrycan as urine is generally sterile and the Jerrycans seal well. While carrying a Jerrycan may not be the most pleasant activity, it is likely more convenient and less costly emptying a pit.

In some locations, urine has an economic value and it may be collected from the household for free. Families who invest the time to transport and use their own urine

may be rewarded with increased agricultural production improving the families health and/or increasing their income.

**Upgrading** If urine is viewed as a commodity, locally run businesses may collect and transport it for free or for a small fee.

**Maintenance** To minimize bacterial growth, sludge accumulation and unpleasant odours, Jerrycans should be washed frequently.

#### Pros & Cons

- + Very low capital and operating costs
- + Potential for local job creation and income generation
- + Easy to clean and reusable
- + Low risk of pathogen transmission
- Heavy to carry
- Spills may happen

#### References

- \_ Austin, A. and Duncker L. (2002). *Urine-diversion. Ecological Sanitation Systems in South Africa*. CSIR, Pretoria, South Africa.
- \_ GTZ (2005). *Technical data sheets for ecosan components-01 Urine Diversion-Piping and Storage*. GTZ, Germany. Available: [www.gtz.de](http://www.gtz.de)
- \_ Morgan, P. (2007). *Toilets that make compost*. Stockholm Environment Institute, Stockholm, Sweden. Available: [www.ecosanres.org](http://www.ecosanres.org)
- \_ Morgan, P. (2004). *An Ecological Approach to Sanitation in Africa: A Compilation of Experiences*. Aquamor, Harare, Zimbabwe. Chapter 10: The usefulness of Urine. Available: [www.ecosanres.org](http://www.ecosanres.org)
- \_ NWP (2006). *Smart Sanitation Solutions. Examples of innovative, low-cost technologies for toilets, collection, transportation, treatment and use of sanitation products*. Netherlands Water Partnership, Netherlands.
- \_ Schonning, C. and Stenstrom, TA. (2004). *Guidelines for the Safe Use of Urine and Faeces in Ecological Sanitation Systems-Report 2004-1*. EcosanRes, Stockholm Environment Institute, Stockholm, Sweden. Available: [www.ecosanres.org](http://www.ecosanres.org)
- \_ Winblad, U. and Simpson-Herbert, M. (eds.) (2004). *Ecological Sanitation - revised and enlarged edition*. Stockholm Environment Institute, Stockholm, Sweden. Available: [www.ecosanres.org](http://www.ecosanres.org)
- \_ WHO (2006). *Guidelines for the safe use of wastewater, Excreta and Greywater- Volume 4: Excreta and Greywater use in agriculture*. WHO, Geneva. Available: [www.who.int](http://www.who.int)

### Application Level

- ★★ Household
- ★★ Neighbourhood
- City

### Management Level

- ★★ Household
- ★★ Shared
- ★★ Public

### Inputs/Outputs:

- Faecal Sludge
- Dried Faeces
- Compost/EcoHumus
- Blackwater

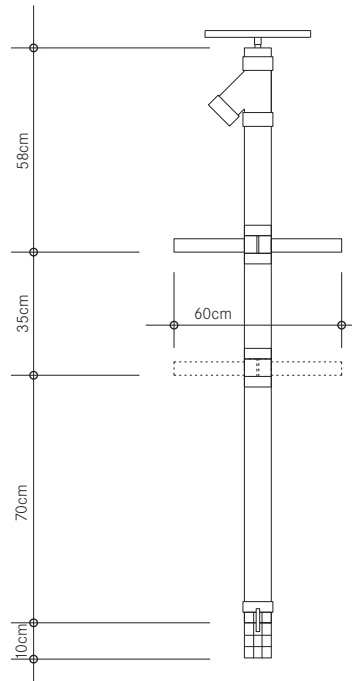

**Human-powered Emptying and Transport refers the different ways in which people can manually empty and/or transport sludge and septage.**

Human-powered Emptying and Transport of pits and tanks can mean one of three things:

- 1) using buckets and shovels;
- 2) using a hand-pump specially designed for sludge (e.g. the Pooh Pump or the Gulper); and
- 3) using a portable, manually operated pump (e.g. MAPET: MAnual Pit Emptying Technology).

Some sanitation technologies can only be emptied manually, for example, the Fossa Alterna (S5) or Dehydration Vaults (S7). These technologies must be emptied with a shovel because the material is solid and cannot be removed with a vacuum or a pump. When sludge is viscous or watery it should be emptied with a hand-pump, a MAPET or a vacuum truck, and not with buckets because of the high risk of collapsing pits, toxic fumes, and exposure to the unsanitized sludge. The type of emptying that can, and should be employed, is very specific to the technology that needs emptying.

Manual sludge pumps like the Pooh Pump or the Gulper are relatively new inventions and have shown promise

as being low-cost, effective solutions for sludge emptying where, because of access, safety or economics, other sludge emptying techniques are not possible. The pump works on the same concept as a water pump: the handle is pumped, the liquid (sludge) rises up through the bottom of the pump and is forced out of a tap (sludge spout). Hand-pumps can be made locally with steels rods and valves in a PVC casing. The bottom of the pipe is lowered down into the pit/tank while the operator remains at the surface to operate the pump, thus removing the need for someone to enter the pit. As the operator pushes and pulls the handle, the sludge is pumped up through the main shaft and is then discharged through the V-shaped discharge spout. The sludge that is discharged can be collected in barrels, bags or carts, and removed from the site with little mess or danger to the operator.

A MAPET consists of a hand pump connected to a vacuum tank mounted on a pushcart. A hose is connected to the tank and is used to suck sludge from a pit. When the hand pump is turned, air is sucked out of the vacuum tank and sludge is sucked up into the tank. Depending on the consistency of the sludge, the MAPET can pump up to a height of 3m.

**Adequacy** Hand-pumps are appropriate for areas that are either not served by vacuum trucks, where vacuum-truck emptying is too costly, or where narrow streets and poor roads may limit the ability of a vacuum truck to access the site. The hand-pump is a significant improvement over the bucket method and could prove to be a sustainable business opportunity in some regions. The MAPET is also well suited to dense, urban and informal settlements, although in both cases, the distance to a suitable sludge discharge point is a limiting factor. These technologies are more feasible when there is a Transfer Station (C7) or Sewage Discharge Station (C8) nearby. One government-run emptying programme implemented a manual emptying scheme with great success by providing employment to community members with adequate protection and an appropriate wage.

**Health Aspects/Acceptance** Depending on cultural factors and political support, manual emptiers may be viewed as providing an important service to the community. Government-run programmes should strive to legitimize the work of the labourer and help improve the social climate by providing permits, licences and helping to legalize the practice of manually emptying latrines. The most important aspect of manual emptying is ensuring that workers are adequately protected with gloves, boots, overalls and facemasks. Regular medical exams and vaccinations should be required for everyone working with sludge.

**Upgrading** To save time, vacuum trucks can be used rather than manual labour if it is appropriate and/or available.

**Maintenance** The MAPET and Sludge Pumps require daily maintenance (cleaning, repairing and disinfection). Workers that manually empty latrines should clean and maintain their protective clothing and tools to prevent contact with the sludge. If manual access to the contents of a pit require breaking open the slab, it may be more cost effective to use a Gulper to empty the latrine. The Gulper cannot empty the entire pit and therefore, emptying may be required

more frequently (once a year), however, this may be a cheaper alternative than replacing a broken slab.

#### Pros & Cons:

- + Potential for local job and income generation
- + Gulper can be built and repaired with locally available materials
- + Low to moderate capital; variable operating costs depending on discharge point (sludge transport over 0.5 km is impractical)
- + Provides service to unsewered areas/communities
- + Easy to clean and reusable
- Spills may happen
- Time consuming: can take several hours/days depending on the size of the pit
- MAPET requires some specialized repair (welding)

#### References

- \_ Eales, K. (2005). *Bringing pit emptying out of the darkness: A comparison of approaches in Durban, South Africa, and Kibera, Kenya*. Building partnerships for Development in Water and Sanitation, UK. Available: [www.bpd-waterandsanitation.org](http://www.bpd-waterandsanitation.org) (A comparison of two manual emptying projects.)
- \_ Ideas at Work (2007). *The 'Gulper' - a manual latrine/drain pit pump*. Ideas at Work, Cambodia. Available: [www.ideas-at-work.org](http://www.ideas-at-work.org)
- \_ Muller, M. and Rijnsburger, J. (1994). *MAPET. Manual Pit-latrine Emptying Technology Project. Development and pilot implementation of a neighbourhood based pit emptying service with locally manufactured handpump equipment in Dar es Salaam, Tanzania. 1988-1992*. WASTE Consultants, Netherlands.
- \_ Oxfam (n.d.). *Manual Desludging Hand Pump (MDHP) Resources*. Oxfam, UK. Available: <http://desludging.org>
- \_ Pickford, J. and Shaw, R. (1997). *Emptying latrine pits. Waterlines*, 16(2): 15-18. (Technical Brief, No. 54). Available: [www.lboro.ac.uk](http://www.lboro.ac.uk)
- \_ Sugden, S. (n.d.). *Excreta Management in Unplanned Areas*. London School of Hygiene and Tropical Medicine, London, UK. Available: <http://siteresources.worldbank.org>

### Application Level

- ★★ Household
- ★★ Neighbourhood
- ★ City

### Management Level

- Household
- ★ Shared
- ★★ Public

### Inputs/Outputs:

- Urine
- Faecal Sludge
- Blackwater

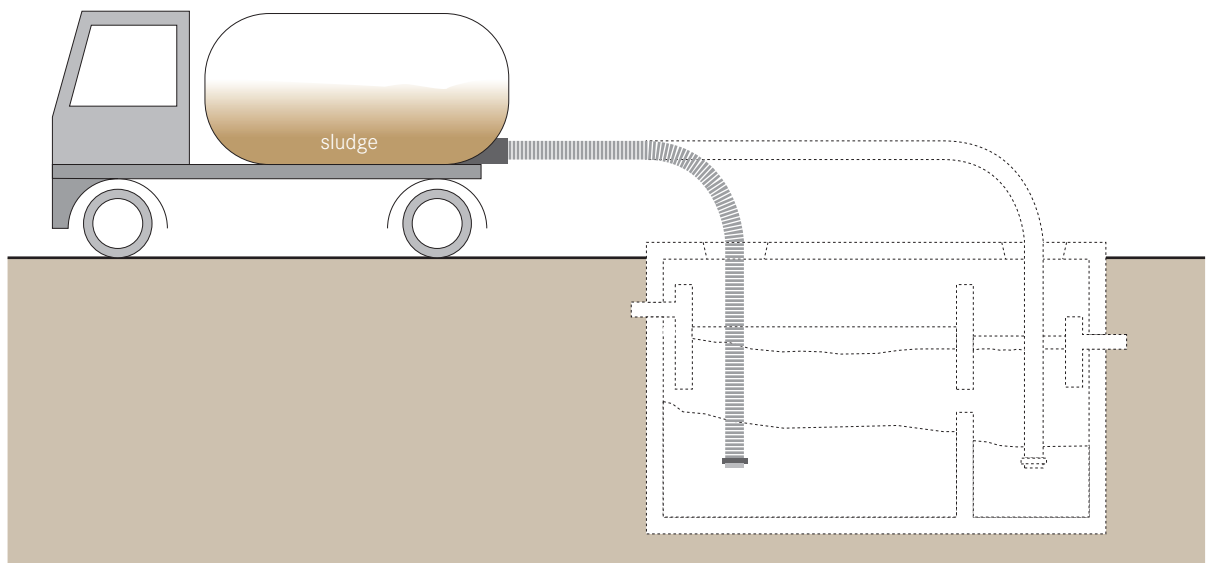

**Motorized Emptying and Transport** refers to a vacuum truck or another vehicle equipped with a motorized pump and a storage tank for emptying and transporting faecal sludge, septage and urine. Humans are required to operate the pump and manoeuvre the hose, but they do not lift or transport the sludge.

The pump is connected to a hose that is lowered down into a constructed tank (e.g. septic tank or aquaprivy) or pit, and the sludge is pumped up into the holding tank on the truck. Generally the storage capacity of a vacuum tanker is between 3,000 and 10,000L. Multiple truckloads may be required for large septic tanks.

Both the agencies responsible for sewerage and private entrepreneurs may operate vacuum trucks, although the price and level of service may vary significantly. Some public operators may not service informal settlements, whereas some private operators may offer a reduced price, but can only afford to do so if they do not empty the sludge at a certified facility. The cost of hiring a vacuum truck can sometimes be the most expensive part of operating a sanitation system for some homeowners.

The UN-HABITAT Vacutug Project was conceived in 1995 with the goal of developing 'fully sustainable system for emptying pit latrines in unplanned, peri-urban areas and refugee camps in the developing countries'. The Vacutug consists of a 0.5 m<sup>3</sup> steel vacuum tank connected to vacuum pump which is connected to a gasoline engine. On level ground, the vehicle is capable of around 5km/h. The waste sludge can be discharged under gravity or by slight pressurization from the pump. Recent results indicate that under certain circumstances (constant number of pits, transfer station, short transfer distance, etc.) the Vacutug can be sustainable and cover its operating and maintenance costs.

**Adequacy** Although smaller more mobile vehicles have been developed, large vacuum trucks remain the norm for municipalities and sanitation authorities. Unfortunately, large trucks cannot access all pits/septic tanks especially in areas with narrow or non-driveable roads. Also, vacuum trucks can rarely make trips to peri-urban or rural areas since the income generated from emptying, may not offset the cost of fuel and time.



Depending on the collection or treatment technology, the material that needs to be pumped can be so dense that it cannot be pumped easily. In these situations it is necessary to thin the solids with water so that they flow more easily, but this may be inefficient and costly. If water is not available, it may be necessary for the waste to be manually removed. In general, the closer the vacuum can be to the pit, the easier it is to empty. The critical velocity of the sludge required for pumping is dependent on the distance from, and strength of, the vacuum pump; sludge is extremely site specific. Garbage and sand also makes emptying the pit much more difficult.

**Health Aspects/Acceptance** The use of a vacuum tanker for emptying a pit latrine or septic tank presents two health improvements: (1) emptying maintains the Collection and Storage/Treatment technology and reduces the risk of overflows and (2) the use of a tanker reduces the need for manual emptying, which is quite unsafe and unhygienic. Still, those who operate vacuum trucks may be demonized by the community and may face difficulties with finding appropriate locations to dump and treat the collected sludge.

**Maintenance** Maintenance is a crucial part of vacuum truck operation. Trucks are not usually brand new and they often require constant attention to prevent breakdowns. The lack of preventive maintenance is often the cause for major repairs.

Most pump trucks are manufactured in North America or Europe. As such, it is difficult to locate spare truck parts and a local mechanic to repair broken pumps and trucks. New trucks are difficult to obtain, very expensive and thus rarely purchased. Local trucks are commonly adapted to serve as vacuum trucks by equipping them with holding tanks and vacuums.

Maintenance accounts for at least one quarter of the costs incurred by the operator of a vacuum truck. Fuel and oil account for another quarter of the total operating costs. Owners/operators must be conscientious to save money for the purchase of expensive replacement parts, tires and equipment, whose replacement could be essential to the working of the vacuum truck.

#### Pros & Cons:

- + Fast, and generally efficient
- + Potential for local job creation and income generation
- + Provides essential service to unsewered areas
- Cannot pump thick dried sludge (must be manually removed or thinned with water)
- Garbage in pits may block hose
- Very high capital costs; variable operating costs depending on use and maintenance
- Pumps can usually only suck down to a depth of 2 to 3m and the pump must be located within 30m of the pit
- Not all parts and materials may be available locally
- May have difficulties with access

#### References

- Brikké, F. and Bredero, M. (2003). *Linking technology choice with operation and maintenance in the context of community water supply and sanitation: A reference document for planners and project staff*. WHO and IRC Water and Sanitation Centre, Geneva.  
Available: [www.who.int](http://www.who.int)  
(Chapter 8 provides an assessment of vacuum emptying.)
- Boesch, A. and Schertenleib, R. (1985). *Pit Emptying On-Site Excreta Disposal Systems. Field Tests with Mechanized Equipment in Gaborone (Botswana)*. IRCWD, Switzerland.  
Available: [www.sandec.ch](http://www.sandec.ch)  
(Comprehensive summary of technical components, performance with different sludge types, and maintenance.)
- Issaias, I. (2007). *UN-HABITAT Vacutug Development Project: Technical report of field trials 2003-2006*. Water, Sanitation and Infrastructure Branch, UN-HABITAT, Nairobi, Kenya.

**Application Level**

- Household
- Neighbourhood
- City

**Management Level**

- Household
- Shared
- Public

**Inputs/Outputs:**

- Blackwater
- Greywater

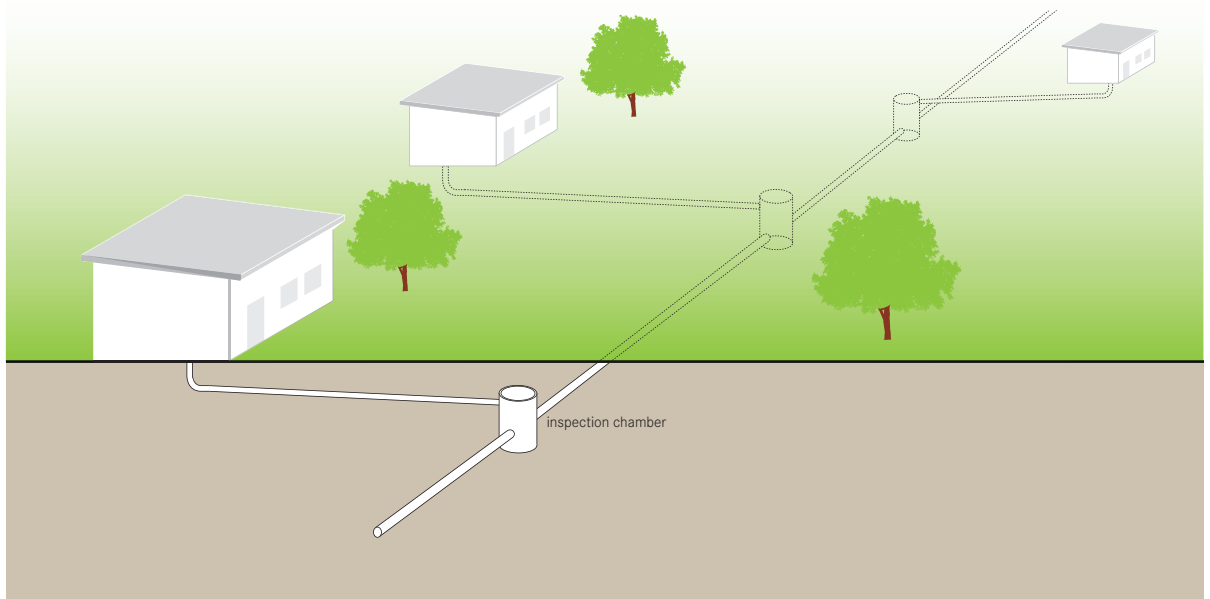

**Simplified Sewers describe a sewerage network that is constructed using smaller diameter pipes laid at a shallower depth and at a flatter gradient than conventional sewers. The Simplified Sewer allows for a more flexible design associated with lower costs and a higher number of connected households.**

Expensive manholes are replaced with simple inspection chambers. Each discharge point is connected to an interceptor tank to prevent settleable solids and trash from entering the sewer. As well, each household should have a grease trap before the sewer connection. Another key design feature is that the sewers are laid within the property boundaries, rather than beneath the central road. Because the sewers are more communal, they are often referred to as condominium sewers. Oftentimes, the community will purchase, and connect to, a single legal connection to the main sewer; the combined effluent of the condominium sewer network flows into the main sewer line.

Because simplified sewers are laid on or around the property of the users, higher connection rates can be achieved, fewer and shorter pipes can be used and less excavation is required as the pipes will not be subject-

ed to heavy traffic loads. However, this type of Conveyance technology requires careful negotiation between stakeholders since design and maintenance must be jointly coordinated.

All greywater should be connected to the Simplified Sewer to ensure adequate hydraulic loading. Inspection chambers also function to attenuate peak discharges into the system. For example, a 100 mm diameter sewer laid at a gradient of 1 m in 200 m (0.5%) will serve around 200 households of 5 people (10,000 users) with a wastewater flow of 80 L/person/day.

Although watertight sewers are the ideal, they may be difficult to achieve, and therefore the sewers should be designed to take into account the extra flow that may result from stormwater infiltration.

Blocks of community-based Simplified Sewers are connected to an existing Conventional Gravity Sewer or routed to a Simplified Sewer main constructed with pipes of a larger diameter. A Simplified Sewer main can still be placed at a shallow depth providing it is placed away from traffic.

**Adequacy** Where the ground is rocky or the ground-water table is high, the excavation of trenches for pipes may be difficult. Under these circumstances, the cost of installing sewers is significantly higher than in favourable conditions. Regardless, Simplified Sewerage is less expensive than Conventional Gravity Sewerage because of its shallow installation depth.

Simplified Sewers can be installed in almost all types of settlements and are especially appropriate for dense, urban settlements. To prevent clogging and maintain the sewers, good pre-treatment is required. It is recommended that the scum from greywater, heavy solids and garbage be removed from the wastewater prior to entering the sewer.

**Health Aspects/Acceptance** If constructed and maintained well, sewers are a safe and hygienic means of transporting wastewater. Users must be well educated about the health risks associated with maintaining/cleaning blockages and inspection chambers.

**Upgrading** Household inspection chambers can be upgraded to septic tanks so that fewer solids enter the Simplified Sewer network, but this will increase maintenance costs associated with emptying the septic tank.

**Maintenance** Pre-treatment with interceptor tanks and a grease trap is essential. The homeowner must maintain the interceptor tanks and the grease trap. Ideally, households will also be responsible for the maintenance of the sewers, however in practice this may not be feasible. Alternatively, a private contractor or users committee can be hired to assume responsibility for the maintenance as inexperienced users may not detect problems before they become severe, and therefore, more costly to repair. A related problem is that households may drain stormwater into the sewer. This practice should be discouraged whenever possible. Blockages can usually be removed by opening the sewer and forcing a length of rigid wire through the sewer. Inspection chambers must be emptied periodically to prevent grit overflowing into the system.

#### Pros & Cons:

- + Can be built and repaired with locally available materials
- + Construction can provide short-term employment to local labourers
- + Capital costs are between 50 and 80% less than Conventional Gravity Sewers; operating costs are low
- + Can be extended as a community changes and grows
- Requires expert design and construction supervision
- Requires repairs and removals of blockages more frequently than a Conventional Gravity Sewer
- Effluent and sludge (from interceptors) requires secondary treatment and/or appropriate discharge

#### References

- \_ Azevedo Netto, MM. and Reid, R. (1992). *Innovative and Low Cost Technologies Utilized in Sewerage*. Technical Series No. 29, Environmental Health Program. Pan American Health Organization, Washington DC. (Refer to Chapters 3 and 4 for component diagrams and design formulae.)
- \_ Bakalian, A., Wright, A., Otis, R. and Azevedo Netto, J. (1994). *Simplified sewerage: design guidelines*. Water and Sanitation Report No. 7. The World Bank + UNDP, Washington. (Design guidelines for manual calculations.)
- \_ HABITAT (1986). *The design of Shallow Sewer Systems*. United Nations Centre for Human Settlements (HABITAT), Nairobi, Kenya. (Detailed design tools and practical examples.)
- \_ Mara, DD. (1996). *Low-Cost Urban Sanitation*. Wiley, Chichester, UK. pp 109-139. (Comprehensive summary including design examples.)
- \_ Mara, DD. (1996). *Low-Cost Sewerage*. Wiley, Chichester, UK. (Assessment of different low-cost systems and case studies.)
- \_ Mara, DD., et al. (2001). *PC-based Simplified Sewer Design*. University of Leeds, England. (Comprehensive coverage of theory and design including a program to be used as a design aid.)
- \_ Watson, G. (1995). *Good Sewers Cheap? Agency-Customer Interactions in Low-Cost Urban Sanitation in Brazil*. The World Bank, Water and Sanitation Division, Washington, DC. (A summary of large scale projects in Brazil.)

**Application Level**

- Household
- Neighbourhood
- City

**Management Level**

- Household
- Shared
- Public

**Inputs/Outputs:**

- Effluent

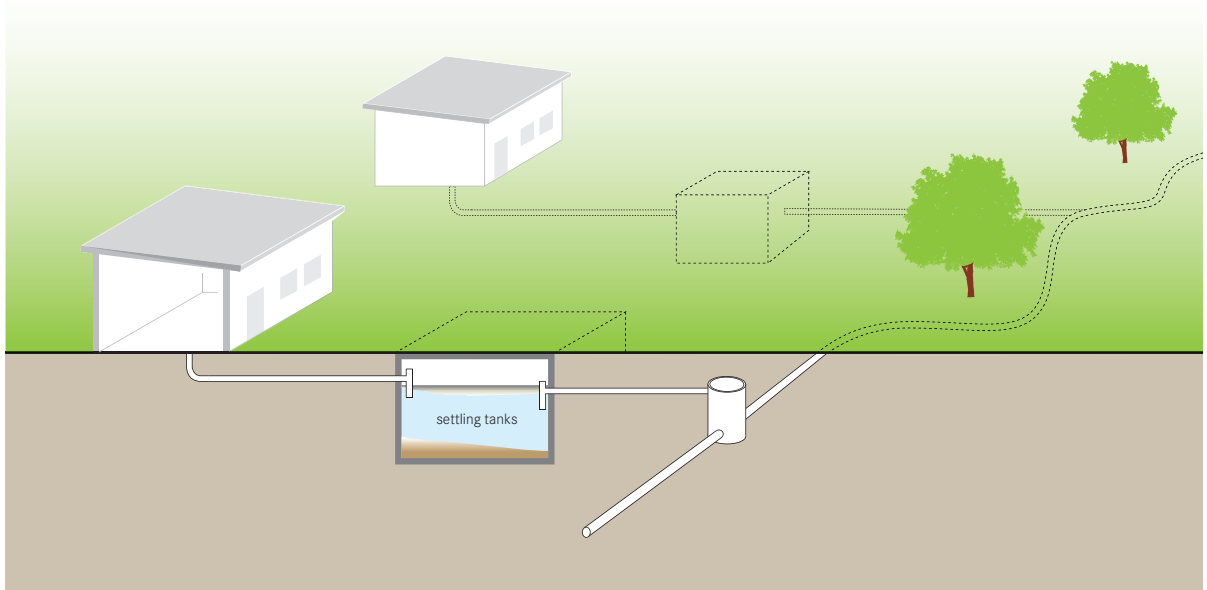

**A Solids-Free Sewer is a network of small diameter pipes that transports solids-free or pre-treated wastewater (such as septic tank or settling tank effluent) to a treatment facility for further treatment or to a discharge point. Solids-Free Sewers are also referred to as settled, small-bore, small-diameter, variable-grade gravity, or septic tank effluent gravity sewers.**

A precondition for Solids-Free Sewer networks is efficient pre-treatment at the household level. The interceptor, septic or settling tank removes settleable particles that could clog small pipes. A grease trap should also be added. Because there is little risk of clogging, the sewers do not have to be self-cleaning (i.e. no minimum flow velocity) and can therefore be laid at shallow depths, can have fewer inspection points (manholes), can follow the topography more closely and have inflective gradients (i.e. negative slope). When the sewer roughly follows the ground contours, the flow in the sewer is allowed to vary between open channel flow and pressure (full-bore) flow. However, care should be taken with negative slopes as they may lead to surging above the ground level during peak flows. Inspection

points should be provided at major connection points or when the size of the pipe changes.

Despite the presence of inflective gradients, the downstream end of the sewer must be lower than the upstream end. When choosing a pipe diameter (at least 75 mm), the depth of water in the pipe during peak flow within each section must be less than the diameter of the pipe. In sections where there is pressure flow, the invert of any interceptor tank outlet must higher than the hydraulic head within the sewer just prior to the point of connection otherwise the liquid will backflow into the tank. If this condition is not met, then either select the next larger pipe diameter for the sewer or increase the depth at which the sewer is laid.

**Adequacy** Solids-Free Sewers are appropriate for both full and partially filled flows. Although a constant supply of water is required, less water is needed compared to the Simple Sewer because self-cleansing velocities are not required.

Septic Tanks and Solids-Free Sewers can be built for new areas, or a Solids-Free Sewer can be connected to an existing primary treatment technology where

local infiltration is inappropriate. A Solids-Free Sewer can be built for 20% to 50% less than Conventional Gravity Sewerage.

This technology must be connected to an appropriate (Semi-) Centralized Treatment technology that can receive the wastewater. It is appropriate for densely populated areas where there is no space for a Soak Pit (D6) or Leach Field (D7). This type of sewer is best suited to urban and less appropriate in low-density or rural areas.

**Health Aspects/Acceptance** This technology requires regular maintenance on the part of the users and is therefore, not as passive as Conventional Gravity Sewers. Users must assume some level of responsibility for the technology and accept that some potentially unpleasant maintenance may be required. Also, users should be aware that, because the system is community based, they may have to work with and/or coordinate maintenance activities with other users. The system will provide a high level of service and may offer a significant improvement to non-functioning Leach Fields (D7).

**Upgrading** Solids-Free Sewers are good upgrading options for Leach Fields (D7) that have become clogged and/or saturated with time as well as for rapidly growing areas that would not accommodate more Septic Tanks with Leach Fields.

**Maintenance** The septic/interceptor tank must be regularly maintained and desludged to insure optimal performance of the Solids-Free Sewer network. If the pre-treatment is efficient, the risk of clogging in the pipes is low, but some maintenance will be required periodically. The sewers should be flushed once a year as part of the regular maintenance regardless of their performance.

#### Pros & Cons:

- + Greywater can be managed at the same time
- + Can be built and repaired with locally available materials
- + Construction can provide short-term employment to local labourers
- + Capital costs are less than Conventional Gravity Sewers; low operating costs
- + Can be extended as a community changes and grows
- Requires expert design and construction supervision
- Requires repairs and removals of blockages more frequently than a Conventional Gravity Sewer
- Requires education and acceptance to be used correctly
- Effluent and sludge (from interceptors) requires secondary treatment and/or appropriate discharge

#### References

- Azevedo Netto, MM. and Reid, R. (1992). *Innovative and Low Cost Technologies Utilized in Sewerage*. Environmental Health Program, Technical Series No. 29. Pan American Health Organization, Washington DC. (A Short summary and component diagrams-Chapter 5.)
- Crites, R. and Tchobanoglous, G. (1998). *Small and Decentralized Wastewater Management Systems*. WCB and McGraw-Hill, New York, USA. pp 355-364. (A short summary of design and construction considerations.)
- Mara, DD. (1996). *Low-Cost Sewerage*. Wiley, Chicheser, UK. (Assessment of different low-cost systems and case studies.)
- Mara, DD. (1996). *Low-Cost Urban Sanitation*. Wiley, Chichester, UK. pp 93-108. (Comprehensive summary including design examples.)
- Otis, RJ. and Mara, DD. (1985). *The Design of Small Bore Sewer Systems (UNDP Interreg. Project INT/81/047)*. TAG Technical Note No.14. United Nations Development Programme + World Bank, Washington. Available: [www.wds.worldbank.org](http://www.wds.worldbank.org) (Comprehensive summary of design, installation and maintenance.)

Application Level	Management Level	Inputs/Outputs:
<input type="checkbox"/> Household	<input type="checkbox"/> Household	<input checked="" type="checkbox"/> Blackwater <input type="checkbox"/> Greywater
<input checked="" type="checkbox"/> Neighbourhood	<input type="checkbox"/> Shared	<input checked="" type="checkbox"/> Brownwater <input type="checkbox"/> Stormwater
<input checked="" type="checkbox"/> City	<input checked="" type="checkbox"/> Public	

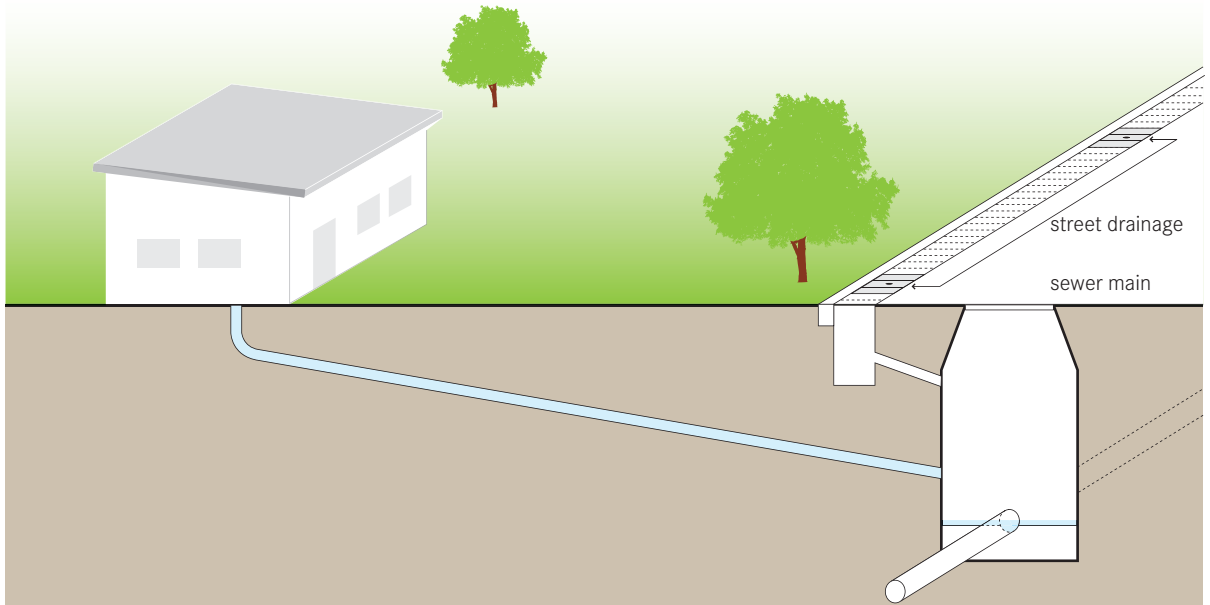

**Conventional Gravity Sewers are large networks of underground pipes that convey blackwater, greywater and stormwater from individual households to a centralized treatment facility using gravity (and pumps where necessary).**

The Conventional Gravity Sewer system is designed with many branches. Typically, the network is subdivided into primary (main sewer lines along main roads), secondary, and tertiary networks (network at the neighbourhood and household level).

Conventional Gravity Sewers do not require onsite pre-treatment or storage of the wastewater. Because the waste is not treated before it is discharged, the sewer must be designed to maintain self-cleansing velocity (i.e. a flow that will not allow particles to accumulate). A self-cleansing velocity is generally 0.6–0.75 m/s. A constant downhill gradient must be guaranteed along the length of the sewer to maintain self-cleaning flows. When a downhill grade cannot be maintained, a pump station must be installed. Primary sewers are laid beneath roads, and must be laid at depths of 1.5 to 3 m to avoid damages caused by traffic loads. Access manholes are placed at set intervals along the

sewer, at pipe intersections and at changes in pipeline direction (vertically and horizontally). The primary network requires rigorous engineering design to ensure that a self-cleansing velocity is maintained, that manholes are placed as required and that the sewer line can support the traffic weight. As well, extensive construction is required to remove and replace the road above.

**Adequacy** Because they carry so much volume, Conventional Gravity sewers are only appropriate when there is a centralized treatment facility that is able to receive the wastewater (i.e. smaller, decentralized facilities could easily be overwhelmed).

Planning, construction, operation and maintenance require expert knowledge. Conventional Gravity Sewers are expensive to build and, because the installation of a sewer line is disruptive and requires extensive coordination between the authorities, construction companies and the property owners, a professional management system must be in place.

When stormwater is also carried by the sewer (called a Combined Sewer), sewer overflows are required. Sewer overflows are needed to avoid hydraulic surcharge of treatment plants during rain events. Infiltration into the

sewer in areas where there is a high water table may compromise the performance of the Conventional Gravity Sewer.

Conventional Gravity Sewers can be constructed in cold climates as they are dug deep into the ground and the large and constant water flow resists freezing.

**Health Aspects/Acceptance** This technology provides a high level of hygiene and comfort for the user at the point of use. However, because the waste is conveyed to an offsite location for treatment, the ultimate health and environmental impacts are determined by the treatment provided by the downstream facility.

**Maintenance** Manholes are installed wherever there is a change of grade or alignment and are used for inspection and cleaning. Sewers can be dangerous and should only be maintained by professionals although, in well-organised communities, the maintenance of tertiary networks might be handed over to a well-trained group of community members.

#### **Pros & Cons:**

- + Stormwater and greywater can be managed at the same time
- + Construction can provide short-term employment to local labourers
- A long time required to connect all homes
- Not all parts and materials may be available locally
- Difficult and costly to extend as a community changes and grows
- Requires expert design and construction supervision
- Effluent and sludge (from interceptors) requires secondary treatment and/or appropriate discharge
- High capital and moderate operation cost

#### **References**

---

- ASCE (1992). *Gravity Sanitary Sewer Design and Construction, ASCE Manuals and Reports on Engineering Practice No. 60, WPCF MOP No. FD-5*. American Society of Civil Engineers, New York.  
(A standard design text used in North America although local codes and standards should be assessed before choosing a design manual.)
- Tchobanoglous, G. (1981). *Wastewater Engineering: Collection and Pumping of Wastewater*. McGraw-Hill, New York.
- Tchobanoglous, G., Burton, F.L. and Stensel, H.D. (2003). *Wastewater Engineering: Treatment and Reuse, 4th Edition*. Metcalf & Eddy, New York.

Application Level	Management Level	Inputs/Outputs:
<input type="checkbox"/> Household <input checked="" type="checkbox"/> Neighbourhood <input checked="" type="checkbox"/> City	<input type="checkbox"/> Household <input checked="" type="checkbox"/> Shared <input checked="" type="checkbox"/> Public	<input checked="" type="checkbox"/> Faecal Sludge

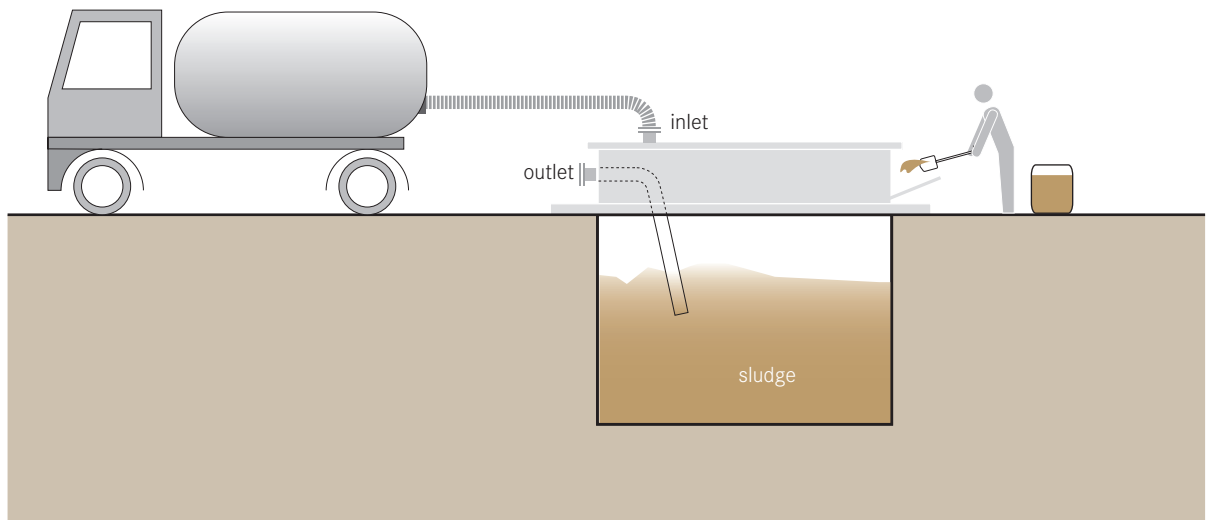

**Sometimes termed Underground Holding Tanks, Transfer Stations act as intermediate dumping points for faecal sludge when it cannot be easily transported to a (Semi-) Centralized Treatment facility. A vacuum truck must empty Transfer Stations when they are full.**

Manual, or small scale sludge emptiers who use the MAPET or the Gulper, for example, dump the sludge in a local transfer station rather than either a) dumping it illegally or b) trying to travel to a distant collection point.

When the Transfer Station is full, a vacuum truck empties the contents and takes the sludge to a suitable treatment facility. If the municipality or sewerage authority is operating the Transfer Station they may charge for permits to dump in the Transfer Station to offset the cost of maintaining the facility.

The Transfer Station consists of a parking place for the vacuum truck or sludge cart, a connection point for the discharge hose, and a storage tank. The dumping point at the Transfer Station should be built low enough to minimize spills when labourers are manually emptying their sludge carts. Additionally, the Transfer Station should

include a vent, a trash screen to remove large debris (garbage) and a washing facility for vehicles.

A variation is the Sewer Discharge Station (SDS), which is like a Transfer station, but is directly connected to a Conventional Gravity Sewer main (for more information, refer to Technology Information Sheet C8: Sewer Discharge Stations). Sludge emptied into the SDS is released either directly or at timed intervals into the sewer main to optimize the performance of the sewer and the wastewater treatment plant, and/or reduce peak loads.

**Adequacy** Transfer Stations are especially appropriate for dense, urban areas where there is no alternative discharge point (e.g. faecal sludge thickening pond). Multiple Transfer Stations in a city may help to reduce the incidence of illegal sewage dumping. The quality and quantity of the faecal sludge will significantly affect the treatment technology that is subsequently required.

Transfer stations are adequate when there are many locations where small-scale sludge emptying is practiced. The construction of a Transfer Station may also stimulate the independent-emptying market. The site for the Transfer Station should be easily accessible, conveniently located, and easy to use. The underground holding tank must be



well constructed to prevent leaching and/or surface water infiltration. Depending on the maintenance of the facility, odours can be unappealing to local residents. However, the benefits gained compared to open-air dumping would likely offset the odour nuisance.

The system for issuing permits or charging access fees must be carefully designed so that those who most need the service are not excluded because of high costs, while still generating enough income to be sustainable and well-maintained.

**Health Aspects/Acceptance** Transfer Stations have the potential to significantly increase the health of a community by providing an inexpensive, local solution to faecal sludge and septage disposal. By providing a Transfer Station, independent or small-scale emptiers are no longer forced to dump sludge illegally; homeowners are more motivated to have their pits emptied. Transfer Stations can be a low-cost, effective Conveyance technology for faecal sludge. When pits are emptied regularly and illegal dumping is minimized, the overall health of a community can be improved significantly. The location must be carefully chosen to maximize efficiency, while minimizing odours and disturbances to nearby residents.

**Upgrading** Transfer stations are relatively common in North America. There, they are equipped with digital data recording devices to track quantities, input types and origin, as well as collect data from the individuals who dump there. In this way, the facilitators can collect detailed information and more accurately plan and adapt to the changing loads.

**Maintenance** Racks (screens) must be cleaned frequently to ensure a constant flow and prevent backups. Sand and grit must also be periodically removed from the holding tank. There should be a well-organized system for emptying the transfer-station; if the holding tank fills up and overflows it is no better than an overflowing pit. The pad and loading area should be cleaned regularly to minimize odours, flies and other vectors from becoming a nuisance.

#### Pros & Cons:

- + Reduces transport distance and may encourage more community-level emptying solutions
- + May reduce illegal dumping of faecal sludge
- + Moderate capital and operating costs; can be offset with access permits
- + Potential for local job creation and income generation
- Requires expert design and construction supervision
- Sludge requires secondary treatment and/or appropriate discharge

#### References

- \_ African Development Fund (2005). *Accra sewerage improvement project- appraisal report*. Infrastructure Department Central and West Regions. Available: [www.afdb.org](http://www.afdb.org)
- \_ Boot, NLD. and Scott, RD. (2008). *Faecal Sludge in Accra, Ghana: problems of urban provision*. Proceedings: Sanitation Challenge: New Sanitation Concepts and Models of Governance. Wageningen, The Netherlands.
- \_ USEPA (1994). *Guide to Septage Treatment and Disposal: EPA/625/R-94/002*. United States Environmental Protection Agency, Office of Research and Development, Cincinnati, Ohio, USA. Available: [www.epa.gov](http://www.epa.gov)

Application Level	Management Level	Inputs/Outputs:
<input type="checkbox"/> Household	<input type="checkbox"/> Household	<input checked="" type="checkbox"/> Faecal Sludge
<input checked="" type="checkbox"/> Neighbourhood	<input type="checkbox"/> Shared	
<input checked="" type="checkbox"/> City	<input checked="" type="checkbox"/> Public	

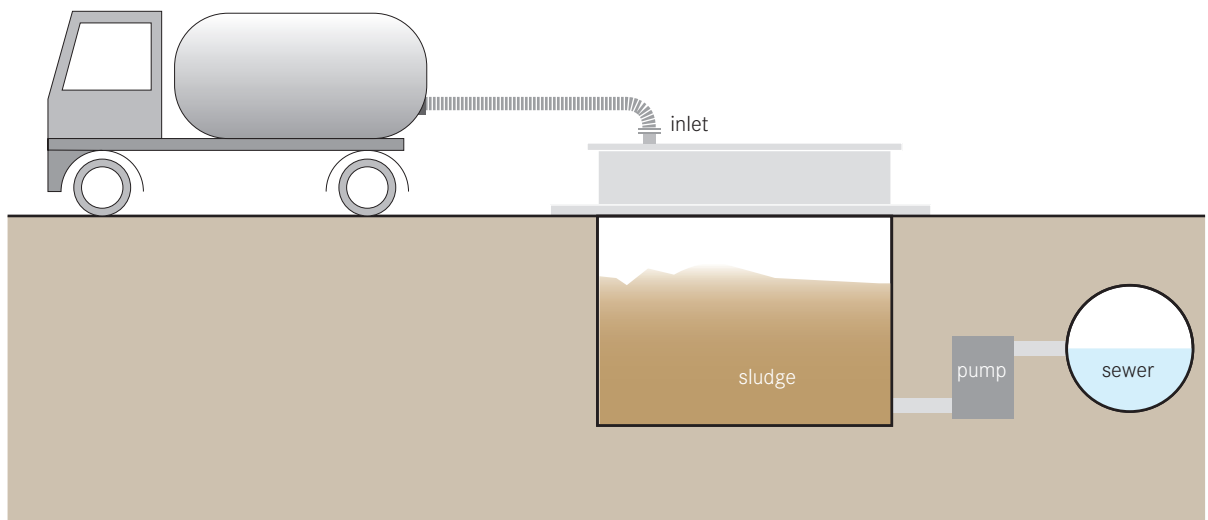

**A Sewer Discharge Station (SDS) is a point along the sewer main that can be legally accessed and used for discharging septage and sludge directly into the sewer so that it can be transported to a (Semi-) Centralized Treatment facility. SDSs are intermediate transfer points for sludge that cannot easily be transported to a dedicated treatment facility. Sludge can be dumped in a local SDS rather than either a) dumping it illegally or b) trying to travel to a distant collection point.**

Sludge is dumped into the SDS and then either released directly to the sewer or held in a temporary storage tank before being released to the sewer at a set time. Timed release can help prevent solids from building up in the sewer line and also help optimize the treatment efficiency of the treatment technology by reducing peak loading.

A SDS consists of a parking place or discharge dock for the vacuum truck or sludge cart and a connection point for the discharge hose. The SDS may also have a storage tank and pumping system. The dumping point should be built low enough to minimize spills when labourers are manually emptying their sludge carts.

Additionally, SDS should include a vent, a trash screen to remove large debris (garbage) and a washing facility for vehicles. The station should be well protected and maintained to prevent random dumping into the sewer and to ensure the safety of the users.

A variation is a stand-alone Transfer Station that is not connected to a sewer main (for more information, refer to C7: Transfer Station (Underground Holding Tank) Technology Information Sheet). When the Transfer Station is full, a vacuum truck must empty the stored contents and take the sludge to a suitable treatment facility. If the municipality or sewerage authority is operating the Transfer Station they may charge for permits to dump in the Transfer Station to offset the cost of maintaining the facility.

**Adequacy** SDSs are especially appropriate for dense, urban areas where there is no alternative discharge point (e.g. faecal sludge thickening pond) and where there is a sewer main. Multiple SDSs in a city may help to reduce the incidence of illegal sewage dumping. The quality and quantity of the faecal sludge will significantly affect the treatment technology that is receiving the sludge.

SDSs are adequate when there are many locations where sludge is manually removed from pit latrines. The construction of an SDS may also stimulate the independent-emptying market. The site for the SDS should be easily accessible, conveniently located, and easy to use. If there is an underground holding tank for timed releases of sludge, it must be well constructed to prevent leaching and/or surface water infiltration. Depending on the maintenance of the facility, odours can be unappealing to local residents. However, the benefits gained compared to open-air dumping would likely offset the odour nuisance.

The system for issuing permits or charging access fees must be carefully designed so that those who most need the service are not excluded because of high costs, while still generating enough income to be sustainable and well-maintained.

**Health Aspects/Acceptance** SDSs have the potential to significantly increase the health of a community by providing an inexpensive, local solution to faecal sludge and septage disposal. Many informal settlements are located near to, if not directly on top of, a sewer line. By building a legitimate access point, the risk of sewer damage and illegal access points may be reduced. When pits are emptied regularly and illegal dumping is minimized, the overall health of a community can be improved significantly.

The location must be carefully chosen to maximize efficiency, while minimizing odours and disturbances to nearby residents.

**Upgrading** SDSs are relatively common in North America, especially in rural communities where septic tanks are common. There, they are equipped with digital data recording devices to track quantities, input types and origin, as well as collect data from the individuals who dump there. In this way, the facilitators can collect detailed information and more accurately plan and adapt to the changing loads.

**Maintenance** Racks (screens) must be cleaned frequently to ensure a constant flow and prevent back-ups. Sand and grit must also be periodically removed from the holding tank. The pad and loading area should be cleaned regularly to prevent smells, flies and other vectors from becoming a nuisance.

#### Pros & Cons:

- + Reduces transport distance and may encourage more community-level emptying solutions
- + May reduce illegal dumping of faecal sludge
- + Moderate capital and operating costs; can be offset with access permits
- + Potential for local job creation and income generation
- Requires expert design and construction supervision
- May cause blockages and disrupt sewer flow
- Sludge requires secondary treatment and/or appropriate discharge

#### References

---

- \_ African Development Fund (2005). *Accra sewerage improvement project- appraisal report*. Infrastructure Department Central and West Regions. Available: [www.afdb.org](http://www.afdb.org)
- \_ Boot, NLD. and Scott, RD. (2008). *Faecal Sludge in Accra, Ghana: problems of urban provision*. Proceedings: Sanitation Challenge: New Sanitation Concepts and Models of Governance. Wageningen, The Netherlands.
- \_ USEPA (1994). *Guide to Septage Treatment and Disposal: EPA/625/R-94/002*. United States Environmental Protection Agency, Office of Research and Development, Cincinnati, Ohio, USA. Available: [www.epa.gov](http://www.epa.gov)

## (Semi-) Centralized Treatment

T

This section describes the technologies that can be used for the treatment of faecal sludge and blackwater. These treatment technologies are designed to accommodate increased volumes of flow and provide, in most cases, improved removal of nutrients, organics and pathogens than household-centered storage technologies.





## T.1 Anaerobic Baffled Reactor (ABR)

Applicable to:  
**System 7**

T.1

### Application Level

- ★★ Household
- ★★ Neighbourhood
- City

### Management Level

- ★★ Household
- ★★ Shared
- ★★ Public

**Inputs:**  Blackwater  Greywater

**Outputs:**  Faecal Sludge  Effluent

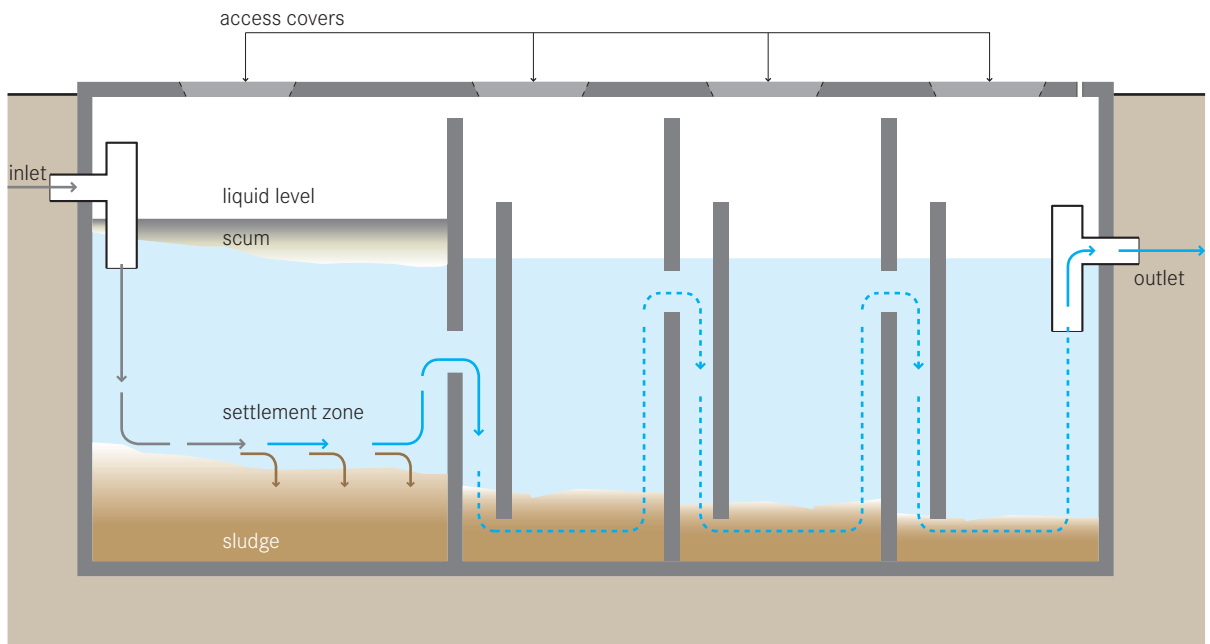

**An Anaerobic Baffled Reactor (ABR) is an improved septic tank because of the series of baffles over which the incoming wastewater is forced to flow. The increased contact time with the active biomass (sludge) results in improved treatment.**

The majority of settleable solids are removed in the sedimentation chamber at the beginning of the ABR, which typically represents 50% of the total volume. The up-flow chambers provide additional removal and digestion of organic matter: BOD may be reduced by up to 90%, which is far superior to that of a conventional septic tank. As sludge is accumulating, desludging is required every 2 to 3 years. Critical design parameters include a hydraulic retention time (HRT) between 48 to 72 hours, up-flow velocity of the wastewater less than 0.6m/h and the number of up-flow chambers (2 to 3).

**Adequacy** This technology is easily adaptable and can be applied at the household level or for a small neighbourhood (refer to Technology Information Sheet S10: Anaerobic Baffled Reactor for information about applying an ABR at the household level).

A (semi-) centralized ABR is appropriate when there is an already existing Conveyance technology, such as a Solids-Free Sewer (C5). This technology is also appropriate for areas where land may be limited since the tank is installed underground and requires a small area. It should not be installed where there is a high groundwater table as infiltration will affect the treatment efficiency and contaminate the groundwater.

This technology can be efficiently designed for a daily inflow of up to 200,000 L/day. The ABR will not operate at full capacity for several months after installation because of the long start up time required for the anaerobic digestion of the sludge. Therefore, the ABR technology should not be used when the need for a treatment system is immediate.

Because the ABR must be emptied regularly, a vacuum truck should be able to access the location. ABRs can be installed in every type of climate although the efficiency will be affected in colder climates.

**Health Aspects/Acceptance** Although the removal of pathogens is not high, the ABR is contained so users do not come in contact with any of the wastewater or disease causing pathogens. Effluent and sludge

must be handled with care as they contain high levels of pathogenic organisms.

To prevent the release of potentially harmful gases, the tank should be vented.

**Maintenance** ABR tanks should be checked to ensure that they are watertight and the levels of the scum and sludge should be monitored to ensure that the tank is functioning well. Because of the delicate ecology, care should be taken not to discharge harsh chemicals into the ABR.

The sludge should be removed annually using a vacuum truck to ensure proper functioning of the ABR.

#### **Pros & Cons:**

- + Resistant to organic and hydraulic shock loads
- + No electrical energy required
- + Greywater can be managed concurrently
- + Can be built and repaired with locally available materials
- + Long service life
- + No real problems with flies or odours if used correctly
- + High reduction of organics
- + Moderate capital costs, moderate operating costs depending on emptying; can be low cost depending on number of users
- Requires constant source of water
- Effluent requires secondary treatment and/or appropriate discharge
- Low reduction pathogens
- Requires expert design and construction
- Pre-treatment is required to prevent clogging

#### **References**

---

- Bachmann, A., Beard, VL. and McCarty, PL. (1985). Performance Characteristics of the Anaerobic Baffled Reactor. *Water Research* 19 (1): 99–106.
- Foxon, KM., et al. (2004). The anaerobic baffled reactor (ABR): An appropriate technology for on-site sanitation. *Water SA* 30 (5) (Special edition). Available: [www.wrc.org.za](http://www.wrc.org.za)
- Sasse, L. (1998). *DEWATS: Decentralised Wastewater Treatment in Developing Countries*. BORDA, Bremen Overseas Research and Development Association, Bremen, Germany. (Design summary including and Excel®-based design program.)

<b>Application Level</b> (★★) Household (★★) Neighbourhood □ City	<b>Management Level</b> (★★) Household (★★) Shared (★★) Public	<b>Inputs:</b> <span style="display:inline-block; width:10px; height:10px; background-color:grey; border:1px solid black;"></span> Blackwater <span style="display:inline-block; width:10px; height:10px; background-color:lightgrey; border:1px solid black;"></span> Greywater
		<b>Outputs:</b> <span style="display:inline-block; width:10px; height:10px; background-color:lightgreen; border:1px solid black;"></span> Faecal Sludge <span style="display:inline-block; width:10px; height:10px; background-color:lightblue; border:1px solid black;"></span> Effluent

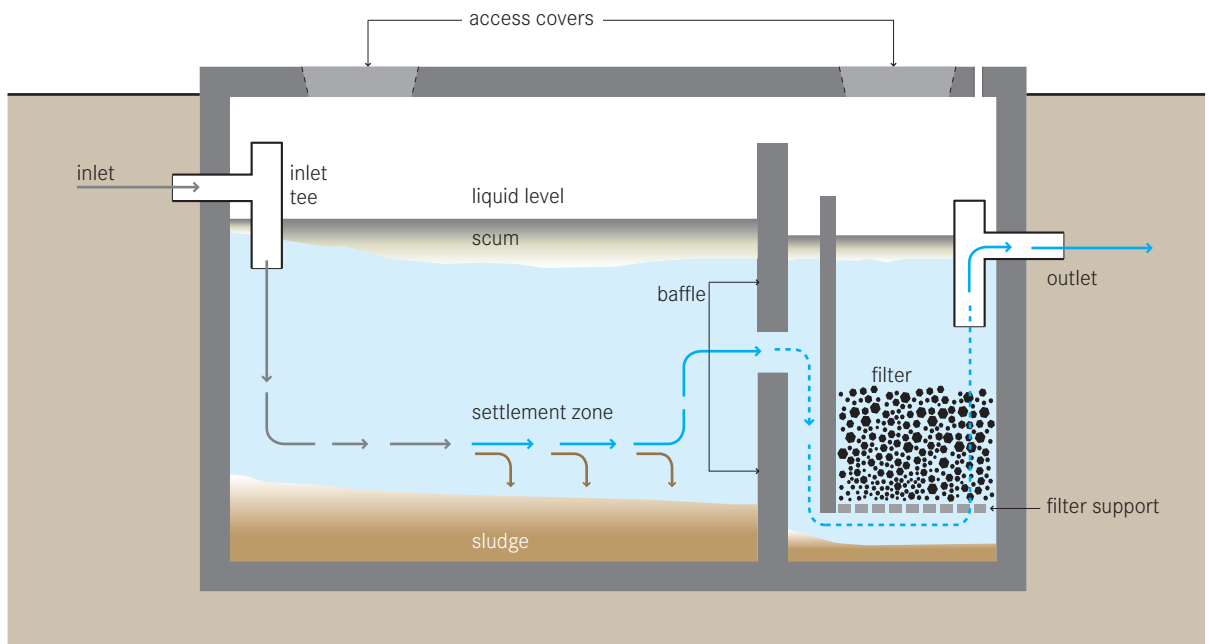

**An Anaerobic Filter is a fixed-bed biological reactor. As wastewater flows through the filter, particles are trapped and organic matter is degraded by the biomass that is attached to the filter material.**

This technology consists of a sedimentation tank or septic tank (refer to Technology Information Sheet S9: Septic Tank) followed by one to three filter chambers. Filter material commonly used includes gravel, crushed rocks, cinder, or specially formed plastic pieces. Typical filter material sizes range from 12 to 55mm in diameter. Ideally, the material will provide between 90 to 300m<sup>2</sup> of surface area per 1 m<sup>3</sup> of reactor volume. By providing a large surface area for the bacterial mass, there is increased contact between the organic matter and the active biomass that effectively degrades it.

The Anaerobic Filter can be operated in either upflow or downflow mode. The upflow mode is recommended because there is less risk that the fixed biomass will be washed out. The water level should cover the filter media by at least 0.3m to guarantee an even flow regime. Pre-treatment is essential to remove settleable solids and garbage which may clog the filter.

Studies have shown that the HRT is the most important design parameter influencing filter performance. An HRT of 0.5 to 1.5 days is a typical and recommended. A maximum surface-loading (i.e. flow per area) rate of 2.8m/d has proven to be suitable. Suspended solids and BOD removal can be as high as 85% to 90% but is typically between 50% and 80%. Nitrogen removal is limited and normally does not exceed 15% in terms of total nitrogen (TN).

**Adequacy** This technology is easily adaptable and can be applied at the household level or a small neighbourhood (refer to Technology Information Sheet S11: Anaerobic Filter for information about applying an Anaerobic Filter at the household level).

An Anaerobic Filter can be designed for a single house or a group of houses that are using a lot of water for clothes washing, showering, and toilet flushing. It is only appropriate if water use is high ensuring that the supply of wastewater is constant.

The Anaerobic Filter will not operate at full capacity for six to nine months after installation because of the long start up time required for the anaerobic biomass to stabilize. Therefore, the Anaerobic Filter technology should



not be used when the need for a treatment system is immediate. Once working at full capacity it is a stable technology that requires little attention.

The Anaerobic Filter should be watertight but it should still not be constructed in areas with high groundwater tables or where there is frequent flooding.

Depending on land availability and the hydraulic gradient of the sewer, the Anaerobic Filter can be built above or below ground. It can be installed in every type of climate, although the efficiency will be affected in colder climates.

**Health Aspects/Acceptance** Because the Anaerobic Filter is underground, users should not come in contact with the influent or effluent. Infectious organisms are not sufficiently removed, so the effluent should be further treated or discharged properly. The effluent, despite treatment, will still have a strong odour and care should be taken to design and locate the facility such that odours do not bother community members.

To prevent the release of potentially harmful gases, the Anaerobic Filters should be vented.

The desludging of the filter is hazardous and appropriate safety precautions should be taken.

**Maintenance** Active bacteria must be added to start up the Anaerobic Filter. The active bacteria can come from sludge from a septic tank that has been sprayed onto the filter material. The flow should be gradually increased over time, and the filter should be working at maximum capacity within six to nine months.

With time, the solids will clog the pores of the filter. As well, the growing bacterial mass will become too thick and will break off and clog pores. A sedimentation tank before the filter is required to prevent the majority of settleable solids from entering the unit. Some clogging increases the ability of the filter to retain solids. When the efficiency of the filter decreases, it must be cleaned. Running the system in reverse mode to dislodge accumulated biomass and particles cleans the filters. Alternatively, the filter material can be removed and cleaned.

#### **Pros & Cons:**

- + Resistant to organic and hydraulic shock loads
- + No electrical energy required
- + Can be built and repaired with locally available materials
- + Long service life
- + No real problems with flies or odours if used correctly
- + Moderate capital costs, moderate operating costs depending on emptying; can be lowered depending on the number of users
- + High reduction of BOD and solids
- Requires constant source of water
- Effluent requires secondary treatment and/or appropriate discharge
- Low reduction pathogens and nutrients
- Requires expert design and construction
- Long start up time

#### **References**

- \_ Morel, A. and Diener, S. (2006). *Greywater Management in Low and Middle-Income Countries, Review of different treatment systems for households or neighbourhoods*. Swiss Federal Institute of Aquatic Science and Technology (Eawag), Dübendorf, Switzerland. (Short summary including case studies, page 28.)
- \_ Polprasert, C. and Rajput, V.S. (1982). *Environmental Sanitation Reviews: Septic Tank and Septic Systems*. Environmental Sanitation Information Center, AIT, Bangkok, Thailand. pp 68-74. (Short design summary.)
- \_ Sasse, L. (1998). *DEWATS: Decentralised Wastewater Treatment in Developing Countries*. BORDA, Bremen Overseas Research and Development Association, Bremen, Germany. (Design summary including Excel-based design program.)
- \_ von Sperlin, M. and de Lemos Chernicharo, CA. (2005). *Biological Wastewater Treatment in Warm Climate Regions. Volume One*. IWA, London. pp 728-804. (Detailed design instructions.)
- \_ Vigneswaran, S., et al. (1986). *Environmental Sanitation Reviews: Anaerobic Wastewater Treatment-Attached growth and sludge blanket process*. Environmental Sanitation Information Center, AIT, Bangkok, Thailand. (Design criteria and diagrams in Chapter 2.)

### Application Level

- Household
- Neighbourhood
- City

### Management Level

- Household
- Shared
- Public

**Inputs:**  Blackwater  Greywater

**Outputs:**  Faecal Sludge  Effluent

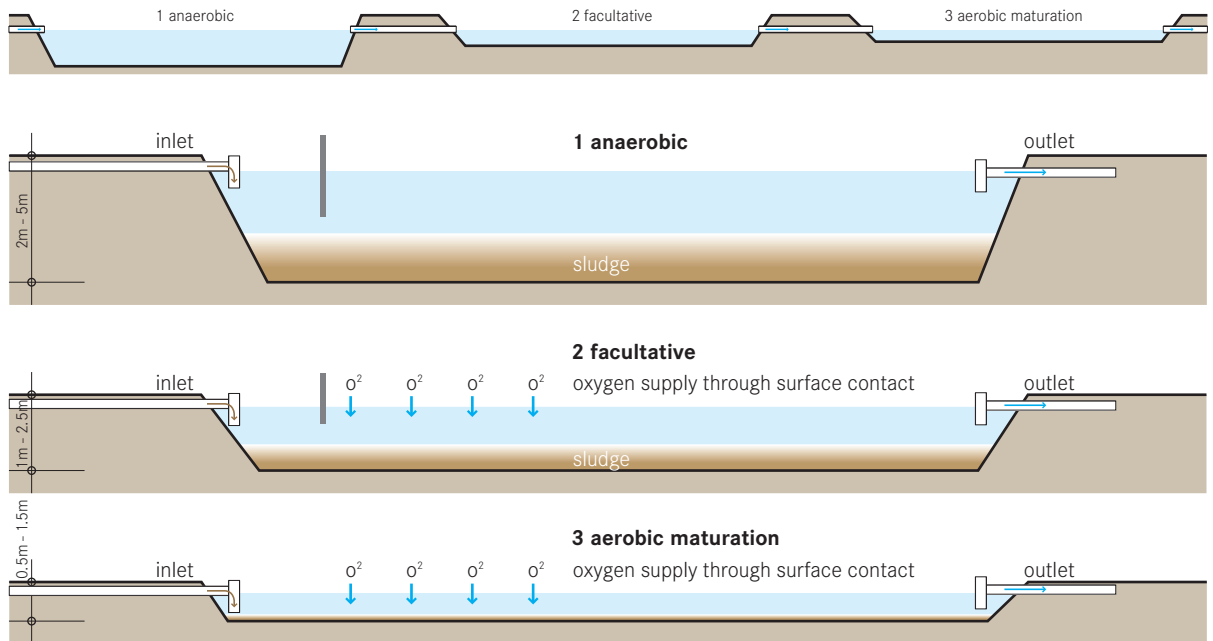

**Waste Stabilization Ponds (WSPs) are large, man-made water bodies. The ponds are filled with wastewater that is then treated by naturally occurring processes. The ponds can be used individually, or linked in a series for improved treatment. There are three types of ponds, (1) anaerobic, (2) facultative and (3) aerobic (maturation), each with different treatment and design characteristics.**

For the most effective treatment, WSPs should be linked in a series of three or more with effluent being transferred from the anaerobic pond to the facultative pond and finally the aerobic pond. The anaerobic pond reduces solids and BOD as a pre-treatment stage. The pond is a fairly deep man-made lake where the entire depth of the pond is anaerobic. Anaerobic ponds are built to a depth of 2 to 5 m and have a relatively short detention time of 1 to 7 days. The actual design will depend on the wastewater characteristics and the loading; a comprehensive design manual should be consulted for all types of WSPs. Anaerobic bacteria convert organic carbon into methane and in the process, remove up to 60% of the BOD. Anaerobic ponds are capable of treating strong wastewaters.

In a series of WSPs the effluent from the anaerobic pond is transferred to the facultative pond, where further BOD is removed. A facultative pond is shallower than an anaerobic pond and both aerobic and anaerobic processes occur within the pond. The top layer of the pond receives oxygen from natural diffusion, wind mixing and algae-driven photosynthesis. The lower layer is deprived of oxygen and becomes anoxic or anaerobic. Settleable solids accumulate and are digested on the bottom of the pond. The aerobic and anaerobic organisms work together to achieve BOD reductions of up to 75%. The pond should be constructed to a depth of 1 to 2.5 m and have a detention time between 5 to 30 days.

Following the anaerobic and the facultative ponds can be any number of aerobic (maturation) ponds to achieve a highly polished effluent. An aerobic pond is commonly referred to as a maturation, polishing, or finishing pond because it is usually the last step in a series of ponds and provides the final level of treatment. It is the shallowest of the ponds, usually constructed to a depth between 0.5 to 1.5 m deep to ensure that the sunlight penetrates the full depth for photosynthesis. Because photosynthesis is driven by sunlight, the dissolved oxygen levels are highest during the day and drop off at night. Whereas anaer-

obic and facultative ponds are designed for BOD removal, maturation ponds are designed for pathogen removal. Dissolved oxygen in the lake is provided by natural wind mixing and by photosynthetic algae that release oxygen into the water. If used in combination with algae and/or fish harvesting, this type of pond is effective at removing the majority of nitrogen and phosphorus from the effluent.

To prevent leaching, the ponds should have a liner. The liner can be clay, asphalt, compacted earth, or another impervious material. To protect the pond from runoff and erosion, a protective berm should be constructed around the pond using the excavated material.

**Adequacy** WSPs are among the most common and efficient methods of wastewater treatment around the world. They are especially appropriate for rural communities that have large, open unused lands, away from homes and public spaces. They are not appropriate for very dense or urban areas.

WSPs work in most climates, but are most efficient in warm, sunny climates. In the case of cold climates, the retention times and loading rates can be adjusted so that efficient treatment can be achieved.

**Health Aspects/Acceptance** Although effluent from aerobic ponds is generally low in pathogens, the ponds should in no way be used for recreation or as a direct source of water for consumption or domestic use.

**Upgrading** Ideally, several aerobic ponds can be built in series to provide a high level of pathogen removal. A final aquaculture pond can be used to generate income and supply a locally grown food source.

**Maintenance** To prevent scum formation, excess solids and garbage from entering the ponds, pre-treatment (with grease traps) is essential to maintain the ponds. The pond must be desludged once every 10 to 20 years. A fence should be installed to ensure that people and animals stay out of the area and excess garbage does not enter the ponds. Rodents may invade the berm and cause damage to the liner. Raising the water level should prompt rodents to evacuate the berm.

Care should be taken to ensure that plant material does not fall into the ponds. Vegetation or macrophytes that are present in the pond should be removed as it may provide a breeding habitat for mosquitoes and prevent light from penetrating the water column.

#### Pros & Cons:

- + High reduction in pathogens
- + Can be built and repaired with locally available materials
- + Construction can provide short-term employment to local labourers
- + Low operating cost
- + No electrical energy required
- + No real problems with flies or odours if designed correctly
- Requires expert design and supervision
- Variable capital cost depending on the price of land
- Requires large land area
- Effluent/sludge requires secondary treatment and/or appropriate discharge

#### References

- \_ Arthur, J.P. (1983). *Notes on the Design and Operation of Waste Stabilization Ponds in Warm Climates of Developing Countries*. The World Bank+ UNDP, Washington.
- \_ Crites, R. and Tchobanoglous, G. (1998). *Small and Decentralized Wastewater Management Systems*. WCB and McGraw-Hill, New York, USA.
- \_ Mara, D.D. and Pearson, H. (1998). *Design Manual for Waste Stabilization Ponds in Mediterranean Countries*. Lagoon Technology International Ltd., Leeds, England.
- \_ Mara, D.D. (1997). *Design Manual for Waste Stabilization Ponds in India*. Lagoon Technology International Ltd., Leeds, England.
- \_ Sasse, L. (1998). *DEWATS: Decentralised Wastewater Treatment in Developing Countries*. BORDA, Bremen Overseas Research and Development Association, Bremen, Germany. (Detailed description and Excel ® Spreadsheet codes for design.)
- \_ von Sperlin, M. and de Lemos Chernicharo, C.A. (2005). *Biological Wastewater Treatment in Warm Climate Regions. Volume One*. IWA, London. pp 495-656.

## T.4 Aerated Pond

Applicable to:  
System 1, 5, 6, 7, 8

T.4

### Application Level

- Household
- Neighbourhood
- City

### Management Level

- Household
- Shared
- Public

**Inputs:**  Blackwater  Greywater

**Outputs:**  Faecal Sludge  Effluent

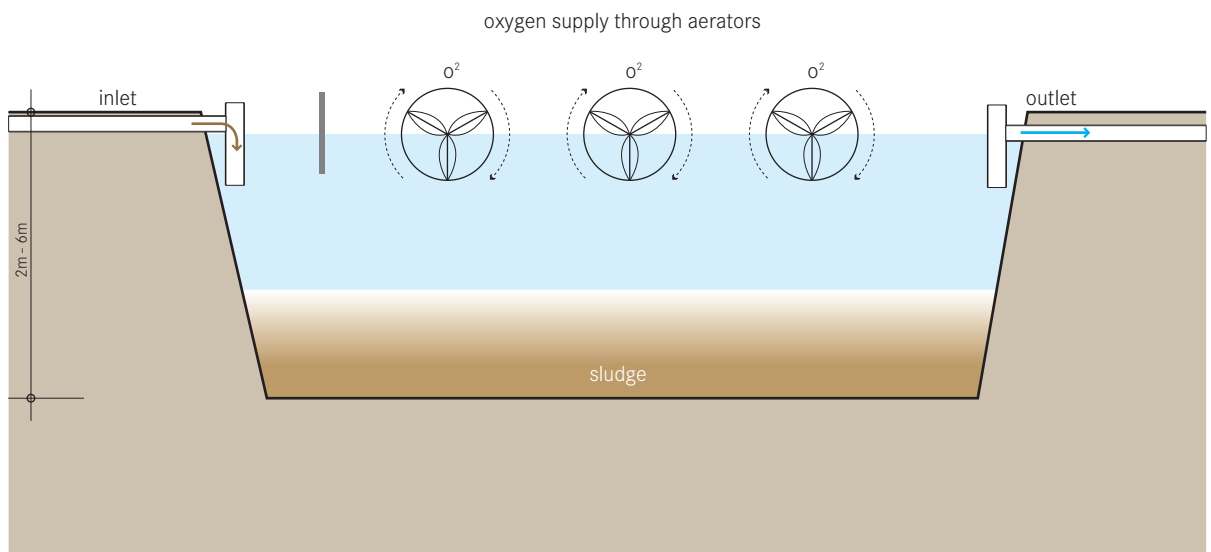

**An Aerated Pond is a large, outdoor, mixed aerobic reactor. Mechanical aerators provide oxygen and keep the aerobic organisms suspended and mixed with the water to achieve a high rate of organic degradation and nutrient removal.**

Increased mixing and aeration from the mechanical units means that the ponds can be deeper and can tolerate much higher organic loads than a maturation pond. The increased aeration allows for increased degradation and increased pathogen removal. As well, because oxygen is introduced by the mechanical units and not by light-driven photosynthesis, the ponds can function in more northern climates. Influent should be screened and pre-treated to remove garbage and coarse particles that could interfere with the aerators. Because the aeration units mix the pond, a subsequent settling tank is required to separate the effluent from the solids.

The smaller area requirement (compared to a maturation pond) means that it is appropriate for both rural, and peri-urban environments.

The pond should be built to a depth of 2 to 5 m and should have a detention time of 3 to 20 days.

To prevent leaching, the pond should have a liner. The liner can be clay, asphalt, compacted earth, or another impervious material. Using the fill that is excavated, a protective berm should be built around the pond to protect it from runoff and erosion.

**Adequacy** A mechanically aerated pond can efficiently handle high concentration influent and can reduce pathogen levels significantly. It is especially important that electricity service is uninterrupted and that replacement parts are available to prevent extended downtimes that may cause the pond to turn anaerobic.

Aerated lagoons can function in a larger range of climates than WSPs. They are most appropriate for regions with large areas of inexpensive lands that are away from homes and businesses.

**Health Aspects/Acceptance** The pond is a large expanse of pathogenic wastewater; care must be taken to ensure that no one comes in contact with, or goes into the water.

The aeration units can be dangerous to humans and animals. Fences, signage, or other measures should be taken to prevent entry to the area.

**Maintenance** A permanent skilled staff is required to repair and maintain aeration machinery. The pond must be desludged once every 2 to 5 years.

Care should be taken to ensure that the pond is not used as a garbage dump, especially considering the damage that could be done to the aeration equipment.

**Pros & Cons:**

- + Good resistance against shock loading
- + High reduction in pathogens
- + Construction can provide short-term employment to local labourers
- + Requires large land area
- + No real problems with insects or odours if designed correctly
- Effluent/sludge requires secondary treatment and/or appropriate discharge
- Requires expert design and construction supervision
- Requires full time operation and maintenance by skilled personnel
- Not all parts and materials may be available locally
- Constant source of electricity is required
- Moderate-high capital and variable operating costs depending on the price of land, electricity

**References**

---

- Arthur, J.P. (1983). *Notes on the Design and Operation of Waste Stabilization Ponds in Warm Climates of Developing Countries*. The World Bank + UNDP, Washington. (Notes on applicability and effectiveness.)
- Crites, R. and Tchobanoglous, G. (1998). *Small and Decentralized Wastewater Management Systems*. WCB and McGraw-Hill, New York, USA. pp 527-558. (Comprehensive summary chapter.)
- Tchobanoglous, G., Burton, F.L. and Stensel, H.D. (2003). *Wastewater Engineering: Treatment and Reuse, 4th Edition*. Metcalf & Eddy, New York. pp 840-85. (Detailed design and example problems.)

## T.5 Free-Water Surface Constructed Wetland

Applicable to:  
System 1, 5, 6, 7, 8

T.5

### Application Level

- ★ Household
- ★★ Neighbourhood
- ★★ City

### Management Level

- ★ Household
- ★★ Shared
- ★★ Public

**Inputs:**  Blackwater  Greywater

**Outputs:**  Effluent

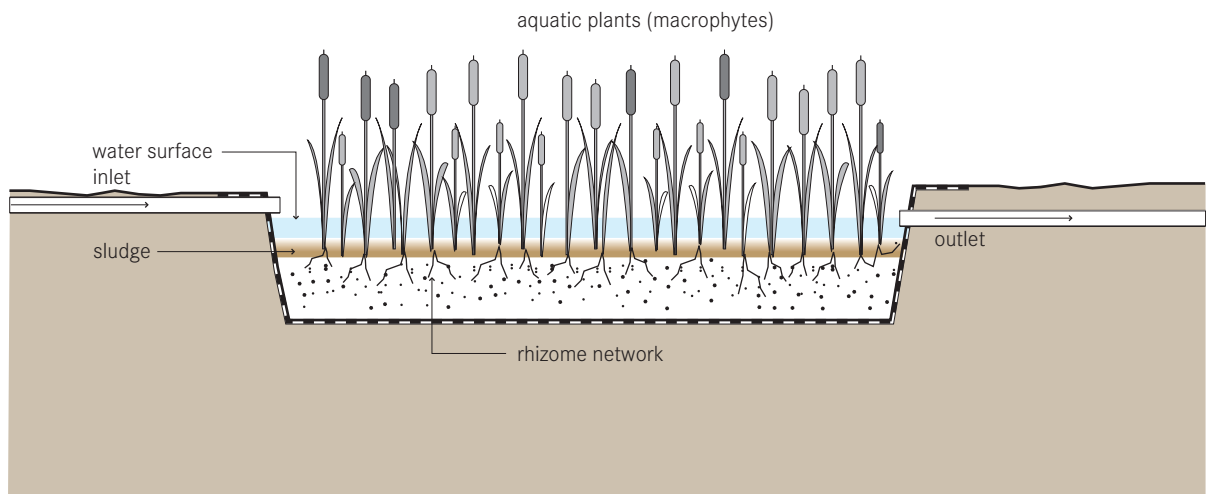

**A Free-Water Surface Constructed Wetland is a series of flooded channels that aims to replicate the naturally occurring processes of a natural wetland, marsh or swamp. As water slowly flows through the wetland, particles settle, pathogens are destroyed, and organisms and plants utilize the nutrients.**

Unlike The Horizontal Subsurface Flow Constructed Wetland (T6), the Free-Water Surface Constructed Wetland allows water to flow above ground, exposed to the atmosphere and direct sunlight. The channel or basin is lined with an impermeable barrier (clay or geotextile) covered with rocks, gravel and soil and planted with native vegetation (e.g. cattails, reeds and/or rushes). The wetland is flooded with wastewater to a depth of 10 to 45cm above ground level. As the water slowly flows through the wetland, simultaneous physical, chemical and biological processes filter solids, degrade organics and remove nutrients from the wastewater.

Raw blackwater should be pretreated to prevent the excess accumulation of solids and garbage. Once in the pond, the heavier sediment particles settle out, also removing nutrients that are attached to particles. Plants, and the communities of microorganisms that

they support (on the stems and roots), take up nutrients like nitrogen and phosphorus. Chemical reactions may cause other elements to precipitate out of the wastewater. Pathogens are removed from the water by natural decay, predation from higher organisms, sedimentation and UV irradiation.

Although the soil layer below the water is anaerobic, the plant roots exude (release) oxygen into the area immediately surrounding the root hairs, thus creating an environment for complex biological and chemical activity.

The efficiency of the Free-Water Surface Constructed Wetland also depends on how well the water is distributed at the inlet. Wastewater can be input to the wetland using weirs or by drilling holes in a distribution pipe to allow it to enter in even spaced intervals.

**Adequacy** Free-Water Surface Constructed Wetlands can achieve high removals of suspended solids and moderate removal of pathogens, nutrients and other pollutants such as heavy metals. Shade from plants and protection from wind mixing limit the dissolved oxygen in the water, therefore, this technology is only appropriate for low strength wastewater. Usually this requires

that Free-Water Surface Constructed Wetlands are only appropriate when they follow some type of primary treatment to lower the BOD.

Depending on the volume of water, and therefore the size, wetlands can be appropriate for small sections of urban areas or more appropriate for peri-urban and rural communities. This is a good treatment technology for communities that have a primary treatment facility (e.g. Septic Tanks (S9)). Where land is cheap and available, it is a good option as long as the community is organized enough to thoroughly plan and maintain the wetland for the duration of its life.

This technology is best suited to warm climates but can be designed to tolerate some freezing and periods of low biological activity.

**Health Aspects/Acceptance** The open surface can act as a potential breeding ground for mosquitoes. However, good design and maintenance can prevent this.

The Free-Water Surface Constructed Wetlands are generally aesthetically pleasing, especially when they are integrated into pre-existing natural areas.

Care should be taken to prevent people from coming in contact with the effluent because of the potential for disease transmission and the risk of drowning in deeper waters.

**Maintenance** Regular maintenance should ensure that water is not short-circuiting, or backing up because of fallen branches, garbage, or beaver dams blocking the wetland outlet. Vegetation may have to be cut back or thinned out periodically.

#### Pros & Cons:

- + Aesthetically pleasing and provides animal habitat
- + High reduction in BOD and solids; moderate pathogen removal
- + Can be built and repaired with locally available materials
- + Construction can provide short-term employment to local labourers
- + No electrical energy required
- + No real problems with flies or odours if used correctly
- May facilitate mosquito breeding
- Long start up time to work at full capacity
- Requires large land area
- Requires expert design and supervision
- Moderate capital cost depending on land, liner, etc.; low operating costs

#### References

- \_ Crites, R. and Tchobanoglous, G. (1998). *Small and Decentralized Wastewater Management Systems*. WCB and McGraw-Hill, New York, USA. pp 582-599. (Comprehensive summary chapter including solved problems.)
- \_ Mara, DD. (2003). *Domestic wastewater treatment in developing countries*. Earthscan, London, UK. pp 85-187.
- \_ Poh-Eng, L. and Polprasert, C. (1998). *Constructed Wetlands for Wastewater Treatment and Resource Recovery*. Environmental Sanitation Information Center, AIT, Bangkok, Thailand.
- \_ Polprasert, C., et al. (2001). *Wastewater Treatment II, Natural Systems for Wastewater Management*. IHE Delft, The Netherlands. Chapter 6.
- \_ QLD DNR (2000). *Guidelines for using free water surface constructed wetlands to treat municipal sewage*. Queensland Government, Department of Natural Resources, Brisbane, Australia. Available: [www.epa.qld.gov.au](http://www.epa.qld.gov.au)

<b>Application Level</b> (★) Household (★★) Neighbourhood (★) City	<b>Management Level</b> (★) Household (★★) Shared (★★) Public	<b>Inputs:</b> <span style="display:inline-block; width:10px; height:10px; background-color:grey; border:1px solid black;"></span> Blackwater <span style="display:inline-block; width:10px; height:10px; background-color:lightgrey; border:1px solid black;"></span> Greywater
		<b>Outputs:</b> <span style="display:inline-block; width:10px; height:10px; background-color:lightgreen; border:1px solid black;"></span> Effluent

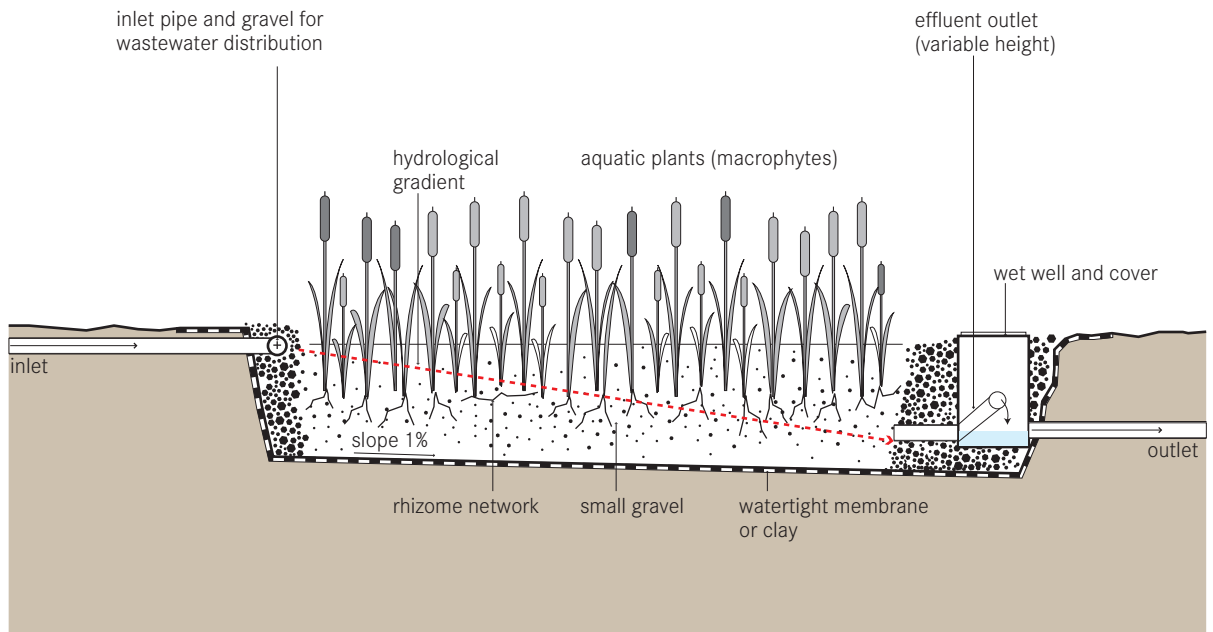

**A Horizontal Subsurface Flow Constructed Wetland is a large gravel and sand-filled channel that is planted with aquatic vegetation. As wastewater flows horizontally through the channel, the filter material filters out particles and microorganisms degrade organics.**

The water level in a Horizontal Subsurface Flow Constructed Wetland is maintained at 5 to 15 cm below the surface to ensure subsurface flow. The bed should be wide and shallow so that the flow path of the water is maximized. A wide inlet zone should be used to evenly distribute the flow. Pre-treatment is essential to prevent clogging and ensure efficient treatment.

The bed should be lined with an impermeable liner (clay or geotextile) to prevent leaching. Small, round, evenly sized gravel (3–32 mm in diameter) is most commonly used to fill the bed to a depth of 0.5 to 1 m. To limit clogging, the gravel should be clean and free of fines. Sand is also acceptable, but is more prone to clogging. In recent years, alternative filter materials such as PET have been successfully used.

The removal efficiency of the wetland is a function of the surface area (length multiplied by width), while the cross-sectional area (width multiplied by depth) deter-

mines the maximum possible flow. A well-designed inlet that allows for even distribution is important to prevent short-circuiting. The outlet should be variable so that the water surface can be adjusted to optimize treatment performance.

The filter media acts as both a filter for removing solids, a fixed surface upon which bacteria can attach, and a base for the vegetation. Although facultative and anaerobic bacteria degrade most organics, the vegetation transfers a small amount of oxygen to the root zone so that aerobic bacteria can colonize the area and degrade organics as well. The plant roots play an important role in maintaining the permeability of the filter.

Any plant with deep, wide roots that can grow in the wet, nutrient-rich environment is appropriate. Phragmites australis (reed) is a common choice because it forms horizontal rhizomes that penetrate the entire filter depth. Pathogen removal is accomplished by natural decay, predation by higher organisms, and sedimentation.

**Adequacy** Clogging is a common problem and therefore the influent should be well settled with primary treatment before flowing into the wetland. This technology is not appropriate for untreated domestic waste-



water (i.e. blackwater). This is a good treatment for communities that have primary treatment (e.g. Septic Tanks (S9) or WSPs (T3)) but are looking to achieve a higher quality effluent. This is a good option where land is cheap and available, although the wetland will require maintenance for the duration of its life.

Depending on the volume of water, and therefore the size, this type of wetland can be appropriate for small sections of urban areas, peri-urban and rural communities. They can also be designed for single households.

Horizontal Subsurface Flow Constructed Wetlands are best suited for warm climates but they can be designed to tolerate some freezing and periods of low biological activity.

**Health Aspects/Acceptance** The risk of mosquito breeding is reduced since there is no standing water compared to the risk associated with Free-Water Surface Constructed Wetlands (T5). The wetland is aesthetically pleasing and can be integrated into wild areas or parklands.

**Maintenance** With time, the gravel will clog with accumulated solids and bacterial film. The filter material will require replacement every 8 to 15 or more years. Maintenance activities should focus on ensuring that primary treatment is effective at reducing the concentration of solids in the wastewater before it enters the wetland. Maintenance should also ensure that trees do not grow in the area as the roots can harm the liner.

#### **Pros & Cons:**

- + Requires less space than a Free-Water Surface Constructed Wetland
- + High reduction in BOD, suspended solids and pathogens
- + Does not have the mosquito problems of the Free-Water Surface Constructed Wetland (T5)
- + Can be built and repaired with locally available materials
- + Construction can provide short-term employment to local labourers
- + No electrical energy required
- Requires expert design and supervision
- Moderate capital cost depending on land, liner, fill, etc.; low operating costs
- Pre-treatment is required to prevent clogging

#### **References**

- Crites, R. and Tchobanoglous, G. (1998). *Small and Decentralized Wastewater Management Systems*. WCB and McGraw-Hill, New York, USA. pp 599–609. (Comprehensive summary chapter including solved problems.)
- Mara, D.D. (2003). *Domestic wastewater treatment in developing countries*. Earthscan, London. pp 85–187.
- Poh-Eng, L. and Polprasert, C. (1998). *Constructed Wetlands for Wastewater Treatment and Resource Recovery*. Environmental Sanitation Information Center, AIT, Bangkok, Thailand.
- Polprasert, C., et al. (2001). *Wastewater Treatment II, Natural Systems for Wastewater Management*. Lectur Notes, IHE Delft, The Netherlands. Chapter 6.
- Reed, S.C. (1993). *Subsurface Flow Constructed Wetlands For Wastewater Treatment, A Technology Assessment*. United States Environmental Protection Agency, USA. Available: [www.epa.gov](http://www.epa.gov) (Comprehensive design manual.)

## T.7 Vertical Flow Constructed Wetland

Applicable to:  
System 1, 5, 6, 7, 8

T.7

### Application Level

- ☐★ Household
- ☐★★ Neighbourhood
- ☐★★ City

### Management Level

- ☐★ Household
- ☐★ Shared
- ☐★★ Public

**Inputs:**  Blackwater  Greywater

**Outputs:**  Effluent

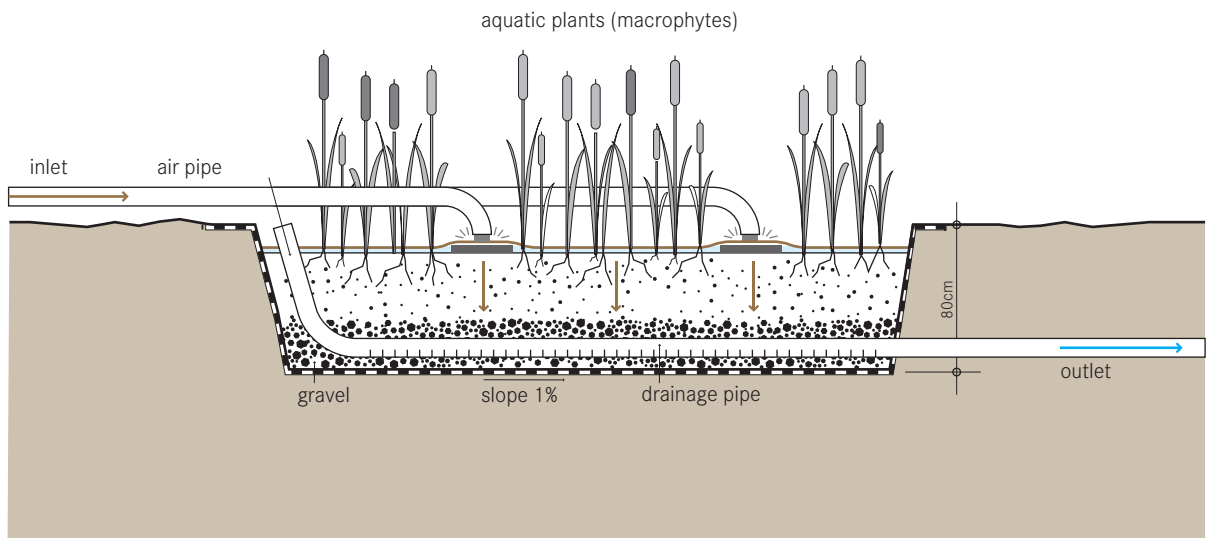

**A Vertical Flow Constructed Wetland is a filter bed that is planted with aquatic plants. Wastewater is poured or dosed onto the wetland surface from above using a mechanical dosing system. The water flows vertically down through the filter matrix. The important difference between a vertical and horizontal wetland is not simply the direction of the flow path, but rather the aerobic conditions.**

By dosing the wetland intermittently (four to ten times a day), the filter goes through stages of being saturated and unsaturated, and accordingly, different phases of aerobic and anaerobic conditions. The frequency of dosing should be timed such that the previous dose of wastewater has time to percolate through the filter bed so that oxygen has time to diffuse through the media and fill the void spaces.

The Vertical Flow Constructed Wetland can be designed as a shallow excavation or as an above ground construction. Each filter should have an impermeable liner and an effluent collection system. Vertical Flow Constructed Wetlands are most commonly designed to treat wastewater that has undergone primary treatment. Structurally, there is a layer of gravel for drainage

(a minimum of 20 cm), followed by layers of either sand and gravel (for settled effluent) or sand and fine gravel (for raw wastewater).

The filter media acts as both a filter for removing solids, a fixed surface upon which bacteria can attach and a base for the vegetation. The top layer is planted and the vegetation is allowed to develop deep, wide roots which permeate the filter media.

Depending on the climate, *Phragmites australis*, *Typha* cattails or *Echinochloa Pyramidalis* are common options. The vegetation transfers a small amount of oxygen to the root zone so that aerobic bacteria can colonize the area and degrade organics. However, the primary role of vegetation is to maintain permeability in the filter and provide habitat for microorganisms.

During a flush phase, the wastewater percolates down through the unsaturated bed and is filtered by the sand/gravel matrix. Nutrients and organic material are absorbed and degraded by the dense microbial populations attached to the surface of the filter media and the roots. By forcing the organisms into a starvation phase between dosing phases, excessive biomass growth can be decreased and porosity increased. A drainage network at the base collects the effluent. The design and

size of the wetland is dependent on hydraulic and organic loads.

Pathogen removal is accomplished by natural decay, predation by higher organisms, and sedimentation.

**Adequacy** Clogging is a common problem. Therefore, the influent should be well settled with primary treatment before flowing into the wetland. This technology is not appropriate for untreated domestic wastewater (i.e. blackwater).

This is a good treatment for communities that have primary treatment (e.g. Septic Tanks (S9) or WSPs (T3)) but are looking to achieve a higher quality effluent. This is a good option where land is cheap and available, although the wetland will require maintenance for the duration of its life.

There are many complex processes at work, and accordingly, there is a significant reduction in BOD, solids and pathogens. In many cases, the effluent will be adequate for discharge without further treatment. Because of the mechanical dosing system, this technology is most appropriate for communities with trained maintenance staff, constant power supply, and spare parts.

Vertical Flow Constructed Wetlands are best suited to warm climates but can be designed to tolerate some freezing and periods of low biological activity.

**Health Aspects/Acceptance** The risk of mosquito breeding is low since there is no standing water. The system is generally aesthetic and can be integrated into wild areas or parklands. Care should be taken to ensure that people do not come in contact with the influent because of the risk of infection.

**Maintenance** With time, the gravel will become clogged with accumulated solids and bacterial film. The material may have to be replaced every 8 to 15 or more years.

Maintenance activities should focus on ensuring that primary treatment effectively lowers organics and solids concentrations before entering the wetland. Testing may be required to determine the suitability of locally available plants with the specific wastewater. The vertical system requires more maintenance and technical expertise than other wetland technologies.

#### Pros & Cons:

- + Does not have the mosquito problems of the Free-Water Surface Constructed Wetland
- + Less clogging than in a Horizontal Flow Constructed Wetland
- + Requires less space than a Free-Water Surface Constructed Wetland
- + High reduction in BOD, suspended solids and pathogens
- + Construction can provide short-term employment to local labourers
- + Constant source of electrical energy required
- Not all parts and materials may be available locally
- Requires expert design and supervision
- Moderate capital cost depending on land, liner, fill, etc.; low operating costs
- Pre-treatment is required to prevent clogging
- Dosing system requires more complex engineering

#### References

- Crites, R. and Tchobanoglous, G. (1998). *Small and Decentralized Wastewater Management Systems*. WCB and McGraw-Hill, New York, USA. pp 599-609. (Comprehensive summary chapter including solved problems.)
- Mara, D.D. (2003). *Domestic wastewater treatment in developing countries*. London, Earthscan, pp 85-187.
- Poh-Eng, L. and Polprasert, C. (1998). *Constructed Wetlands for Wastewater Treatment and Resource Recovery*. Environmental Sanitation Information Center, AIT, Bangkok, Thailand.
- Polprasert, C., et al. (2001). *Wastewater Treatment II, Natural Systems for Wastewater Management*. Lecture Notes. IHE Delft, The Netherlands. Chapter 6.
- Reed, S.C. (1993). *Subsurface Flow Constructed Wetlands For Wastewater Treatment, A Technology Assessment*. United States Environmental Protection Agency, USA. Available: [www.epa.gov](http://www.epa.gov) (Comprehensive design manual.)

## T.8 Trickling Filter

Applicable to:  
System 1, 5, 6, 7, 8

T.8

### Application Level

- Household
- Neighbourhood
- City

### Management Level

- Household
- Shared
- Public

**Inputs:**  Blackwater  Greywater

**Outputs:**  Sludge  Effluent

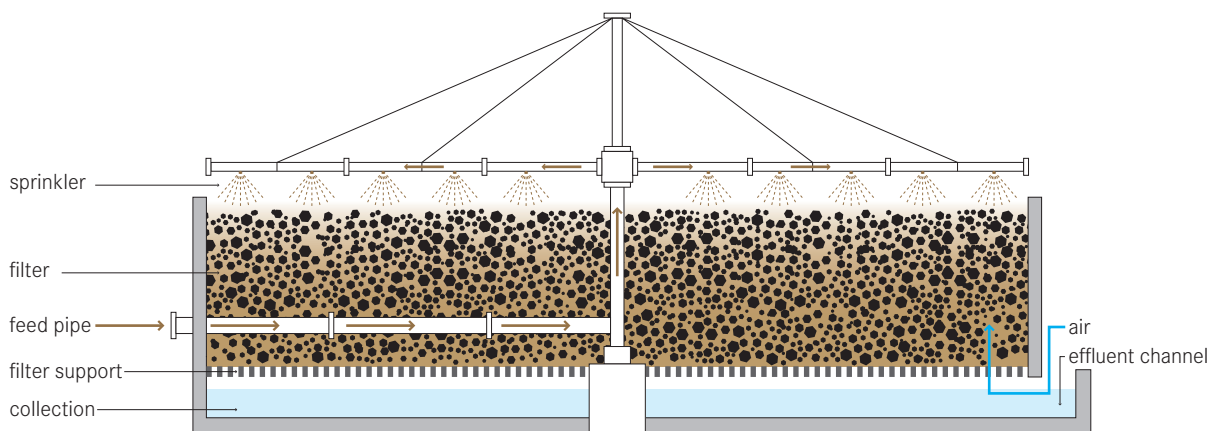

**A Trickling Filter is a fixed bed, biological filter that operates under (mostly) aerobic conditions. Pre-settled wastewater is 'trickled' or sprayed over the filter. As the water migrates through the pores of the filter, organics are degraded by the biomass covering the filter material.**

The Trickling Filter is filled with a high specific surface-area material such as rocks, gravel, shredded PVC bottles, or special pre-formed filter material. A material with a specific surface area between 30 and 900 m<sup>2</sup>/m<sup>3</sup> is desirable. Pre-treatment is essential to prevent clogging and to ensure efficient treatment. The pre-treated wastewater is 'trickled' over the surface of the filter. Organisms that grow in a thin biofilm over the surface of the media oxidize the organic load in the wastewater to carbon dioxide and water while generating new biomass.

The incoming wastewater is sprayed over the filter with the use of a rotating sprinkler. In this way, the filter media goes through cycles of being dosed and exposed to air. However, oxygen is depleted within the biomass and the inner layers may be anoxic or anaerobic.

The filter is usually 1 to 3 m deep but filters packed with lighter plastic filling can be up to 12 m deep. The ideal

filter material has a high surface to volume ratio, is light, durable and allows air to circulate. Whenever it is available, crushed rock or gravel is the cheapest option. The particles should be uniform such that 95% of the particles have a diameter between 7 and 10 cm.

Both ends of the filter are ventilated to allow oxygen to travel the length of the filter. A perforated slab that allows the effluent and excess sludge to be collected supports the bottom of the filter.

With time, the biomass will grow thick and the attached layer will be deprived of oxygen; it will enter an endogenous state, will lose its ability to stay attached and will slough off. High-rate loading conditions will also cause sloughing. The collected effluent should be clarified in a settling tank to remove any biomass that may have dislodged from the filter. The hydraulic and nutrient loading rate (i.e. how much wastewater can be applied to the filter) is determined based on the characteristics of the wastewater, the type of filter media, the ambient temperature, and the discharge requirements.

**Adequacy** This technology can only be used following primary clarification since high solids loading will cause the filter to clog. A skilled operator is required to

monitor and repair the filter and the pump in case of problems. A low-energy (gravity) trickling system can be designed, but in general, a continuous supply of power and wastewater is required.

Compared to other technologies (e.g. WSPs), trickling filters are compact, although they are still best suited for peri-urban or large, rural settlements.

Trickling Filters can be built in almost all environments, although special adaptations for cold climates are required.

**Health Aspects/Acceptance** The odour and fly problems require that the filter be built away from homes and businesses. There must be appropriate measures taken for pre-treatment, effluent discharge and solids treatment, all of which can still pose health risks.

**Maintenance** The sludge that accumulates on the filter must be periodically washed away to prevent clogging. High hydraulic loading rates can be used to flush the filter.

The packing must be kept moist. This may be problematic at night when the water flow is reduced or when there are power failures.

#### Pros & Cons:

- + Can be operated at a range of organic and hydraulic loading rates
- + Small land area required compared to Constructed Wetlands
- High capital costs and moderate operating costs
- Requires expert design and construction
- Requires constant source of electricity and constant wastewater flow
- Flies and odours are often problematic
- Not all parts and materials may be available locally
- Pre-treatment is required to prevent clogging
- Dosing system requires more complex engineering

#### References

- U.S. EPA (2000). *Wastewater Technology Fact Sheet-Trickling Filters, 832-F-00-014*. US Environmental Protection Agency, Washington.  
Available: [www.epa.gov](http://www.epa.gov)  
(Design summary including tips for trouble shooting.)
- Sasse, L. (1998). *DEWATS: Decentralised Wastewater Treatment in Developing Countries*. BORDA, Bremen Overseas Research and Development Association, Bremen, Germany.  
(Provides a short description of the technology.)
- Tchobanoglous, G., Burton, F.L. and Stensel, H.D. (2003). *Wastewater Engineering: Treatment and Reuse, 4th Edition*. Metcalf & Eddy, New York. pp 890–930 .  
(Detailed description and example calculations.)

<b>Application Level</b> <input type="checkbox"/> Household <input checked="" type="checkbox"/> Neighbourhood <input checked="" type="checkbox"/> City	<b>Management Level</b> <input type="checkbox"/> Household <input type="checkbox"/> Shared <input checked="" type="checkbox"/> Public	<b>Inputs:</b> <input checked="" type="checkbox"/> Blackwater <input type="checkbox"/> Greywater
		<b>Outputs:</b> <input checked="" type="checkbox"/> Treated Sludge <input type="checkbox"/> Effluent <input checked="" type="checkbox"/> Biogas

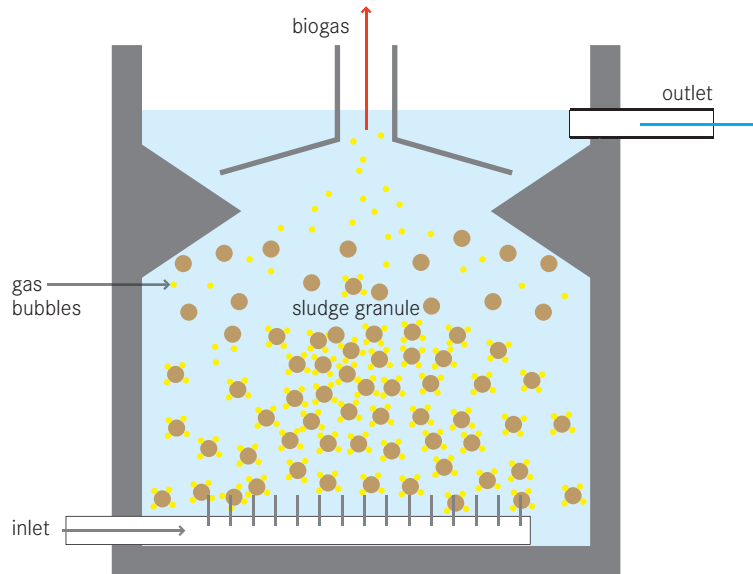

**The Upflow Anaerobic Sludge Blanket Reactor (UASB) is a single tank process. Wastewater enters the reactor from the bottom, and flows upward. A suspended sludge blanket filters and treats the wastewater as the wastewater flows through it.**

The sludge blanket is comprised of microbial granules, i.e. small agglomerations (0.5 to 2 mm in diameter) of microorganisms that, because of their weight, resist being washed out in the upflow. The microorganisms in the sludge layer degrade organic compounds. As a result, gases (methane and carbon dioxide) are released. The rising bubbles mix the sludge without the assistance of any mechanical parts. Sloped walls deflect material that reaches the top of the tank downwards. The clarified effluent is extracted from the top of the tank in an area above the sloped walls.

After several weeks of use, larger granules of sludge form which in turn act as filters for smaller particles as the effluent rises through the cushion of sludge. Because of the upflow regime, granule-forming organisms are preferentially accumulated as the others are washed out.

The gas that rises to the top is collected in a gas collection dome and can be used as energy (biogas). An upflow velocity of 0.6 to 0.9 m/h must be maintained to keep the sludge blanket in suspension.

**Adequacy** A UASB is not appropriate for small or rural communities without a constant water supply or electricity. A skilled operator is required to monitor and repair the reactor and the pump in case of problems. Although the technology is simple to design and build, it is not well proven for domestic wastewater, although new research is promising.

The UASB reactor has the potential to produce higher quality effluent than septic tanks (S9), and can do so in a smaller reactor volume. Although it is a well-established process for large-scale industrial wastewater treatment processes, its application to domestic sewage is still relatively new. Typically it is used for brewery, distillery, food processing and pulp and paper waste since the process can typically remove 85% to 90% of Chemical Oxygen Demand (COD). Where the influent is low strength, the reactor may not work properly. Temperature will also affect performance.

**Health Aspects/Acceptance** UASB is a centralized treatment technology that must be operated and maintained by professionals. As with all wastewater processes, operators should take proper health and safety measures while working in the plant.

**Maintenance** Desludging is infrequent and only excess sludge is removed once every 2 to 3 years. A permanent operator is required to control and monitor the dosing pump.

**Pros & Cons:**

- + High reduction in organics
- + Can withstand high organic loading rates (up to 10kg BOD/m<sup>3</sup>/d) and high hydraulic loading rates
- + Low production sludge (and thus, infrequent desludging required)
- + Biogas can be used for energy (but usually requires scrubbing first)
- Difficult to maintain proper hydraulic conditions (upflow and settling rate must be balanced)
- Long start up time
- Treatment may be unstable with variable hydraulic and organic loads
- Constant source of electricity is required
- Not all parts and materials may be available locally
- Requires expert design and construction supervision

**References**

- \_ Crites, R. and Tchobanoglous, G. (1998). *Small and decentralized wastewater management systems*. WCB and McGraw-Hill, New York, USA. (Short overview.)
- \_ Lettinga, G., Roersma, R. and Grin, P. (1983). *Anaerobic Treatment of Raw Domestic Sewage at Ambient Temperatures Using a Granular Bed UASB Reactor* *Bio-technology and Bioengineering* 25 (7): 1701-1723. (The first paper describing the process.)
- \_ Sasse, L. (1998). *DEWATS: Decentralised Wastewater Treatment in Developing Countries*. BORDA, Bremen Overseas Research and Development Association, Bremen, Germany. (Short overview.)
- \_ von Sperlin, M. and de Lemos Chernicharo, CA. (2005). *Biological Wastewater Treatment in Warm Climate Regions. Volume One*. IWA, London, pp 741-804. (Detailed design information)
- \_ Tare, V. and Nema, A. (n.d). *UASB Technology-expectations and reality*. United Nations Asian and Pacific Centre for Agricultural Engineering and Machinery. Available: <http://unapcaem.org> (Assessment of UASB installations in India.)
- \_ Vigneswaran, S., et al. (1986). *Environmental Sanitation Reviews: Anaerobic Wastewater Treatment- Attached growth and sludge blanket process*. Environmental Sanitation Information Center, AIT, Bangkok, Thailand. (Chapter 5 provides a good technical overview.)

<b>Application Level</b> <input type="checkbox"/> Household <input checked="" type="checkbox"/> Neighbourhood <input checked="" type="checkbox"/> City	<b>Management Level</b> <input type="checkbox"/> Household <input type="checkbox"/> Shared <input checked="" type="checkbox"/> Public	<b>Inputs:</b> <input checked="" type="checkbox"/> Blackwater <input type="checkbox"/> Greywater
		<b>Outputs:</b> <input checked="" type="checkbox"/> Treated Sludge <input type="checkbox"/> Effluent

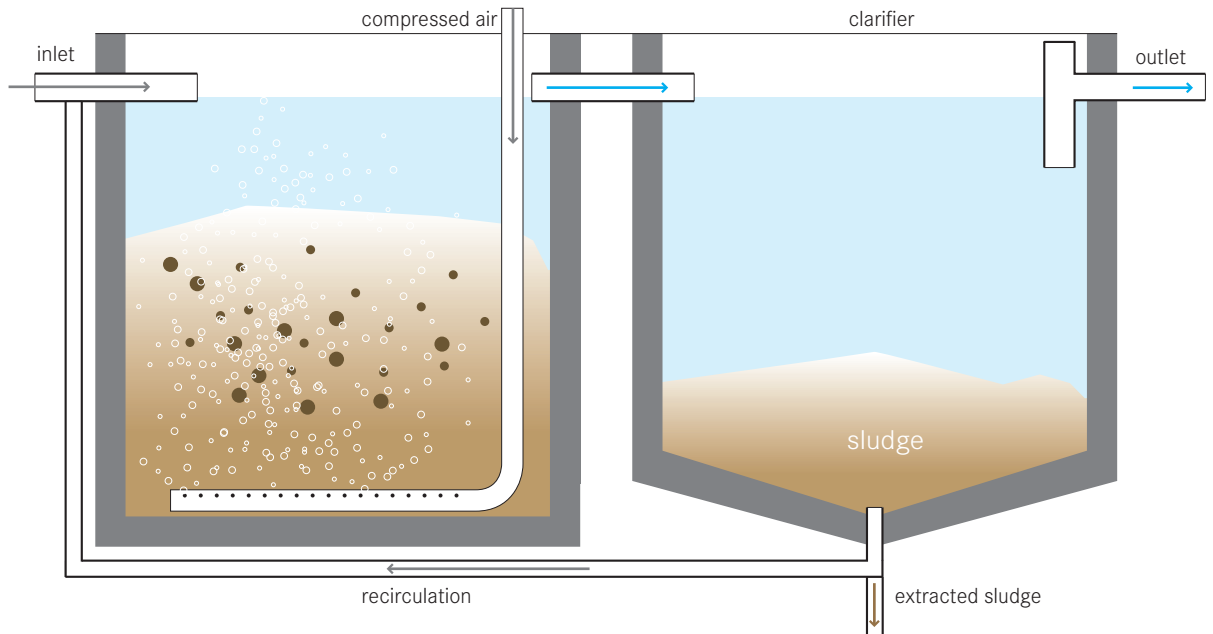

**Activated Sludge is a multi-chamber reactor unit that makes use of (mostly) aerobic microorganisms to degrade organics in wastewater and to produce a high-quality effluent. To maintain aerobic conditions and to keep the active biomass suspended, a constant and well-timed supply of oxygen is required.**

Different configurations of the Activated Sludge process can be employed to ensure that the wastewater is mixed and aerated (with either air or pure oxygen) in an aeration tank. The microorganisms oxidize the organic carbon in the wastewater to produce new cells, carbon dioxide and water. Although aerobic bacteria are the most common organisms, aerobic, anaerobic, and/or nitrifying bacteria along with higher organisms can be present. The exact composition depends on the reactor design, environment, and wastewater characteristics. During aeration and mixing, the bacteria form small clusters, or flocs. When the aeration stops, the mixture is transferred to a secondary clarifier where the flocs are allowed to settle out and the effluent moves on for further treatment or discharge. The sludge is then recycled back to the aeration tank, where the process is repeated.

To achieve specific effluent goals for BOD, nitrogen and phosphorus, different adaptations and modifications have been made to the basic Activated Sludge design. Aerobic conditions, nutrient-specific organisms (especially for phosphorus), recycle design and carbon dosing, among others, have successfully allowed Activated Sludge processes to achieve high treatment efficiencies.

**Adequacy** Activated Sludge is only appropriate for a centralized treatment facility with a well-trained staff, constant electricity and a highly developed centralized management system to ensure that the facility is operated and maintained correctly.

Activated Sludge processes are one part of a complex treatment system. They are used following primary treatment (that removes settleable solids) and before a final polishing step. The biological processes that occur are effective at removing soluble, colloidal and particulate organic materials for biological nitrification and denitrification and for biological phosphorus removal. This technology is effective for the treatment of large volumes of flows: 10,000 to 1,000,000 people. Highly trained staff is required for maintenance and trouble-shooting. The design must be based on an accu-



rate estimation of the wastewater composition and volume. Treatment efficiency can be severely compromised if the plant is under- or over- designed.

An Activated Sludge process is appropriate for almost every climate.

**Health Aspects/Acceptance** Because of space requirements, Centralized treatment facilities are generally located away from the densely populated areas that they serve. Although the effluent produced is of high quality, it still poses a health risk and should not be handled directly.

**Maintenance** The mechanical equipment (mixers, aerators and pumps) must be maintained constantly. As well, the influent and effluent must be monitored constantly to ensure that there are no abnormalities that could kill the active biomass and to ensure that detrimental organisms have not developed that could impair the process (e.g. filamentous bacteria).

#### Pros & Cons:

- + Good resistance against shock loading
- + Can be operated at a range of organic and hydraulic loading rates
- + High reduction of BOD and pathogens (up to 99%)
- + Can be modified to meet specific discharge limits
- Prone to complicated chemical and microbiological problems
- Effluent might require further treatment/ disinfection before discharge
- Not all parts and materials may be available locally
- Requires expert design and supervision
- High Capital cost; high operation cost
- Constant source of electricity is required
- Effluent and sludge require secondary treatment and/or appropriate discharge

#### References

- \_ Crites, R. and Tchobanoglous, G. (1998). *Small and Decentralized Wastewater Management Systems*. WCB and McGraw-Hill, New York, USA. pp 451-504. (Comprehensive summary including solved problems.)
- \_ Ludwig, HF. and Mohit, K. (2000). Appropriate technology for municipal sewerage/Excreta management in developing countries, Thailand case study. *The Environmentalist* 20(3): 215-219. (Assessment of the appropriateness of Activated Sludge for Thailand.)
- \_ von Sperling, M. and de Lemos Chernicharo, CA. (2005). *Biological Wastewater Treatment in Warm Climate Regions, Volume Two*. IWA, London.
- \_ Tchobanoglous, G., Burton, FL. and Stensel, HD. (2003). *Wastewater Engineering: Treatment and Reuse, 4th Edition*. Metcalf & Eddy, New York.

<b>Application Level</b> <input type="checkbox"/> Household <input checked="" type="checkbox"/> Neighbourhood <input checked="" type="checkbox"/> City	<b>Management Level</b> <input type="checkbox"/> Household <input type="checkbox"/> Shared <input checked="" type="checkbox"/> Public	<b>Inputs:</b> <input checked="" type="checkbox"/> Faecal Sludge
		<b>Outputs:</b> <input checked="" type="checkbox"/> Faecal Sludge <input checked="" type="checkbox"/> Effluent

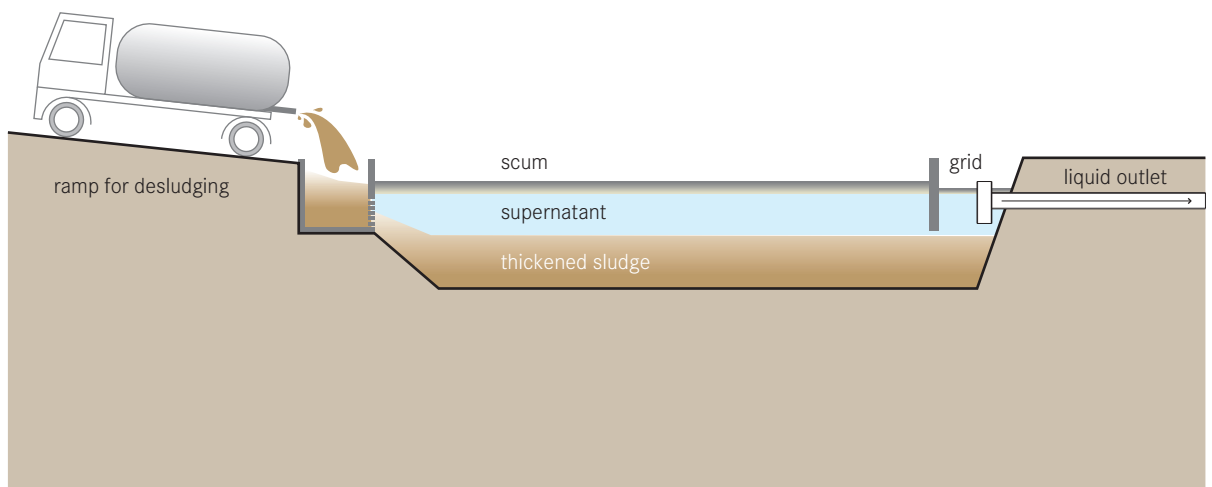

**Sedimentation or Thickening Ponds are simple settling ponds that allow the sludge to thicken and dewater. The effluent is removed and treated, while the thickened sludge can be treated in a subsequent technology.**

Faecal sludge is not a uniform product and therefore, its treatment must be specific to the characteristics of the specific sludge. In general, there are two types of faecal sludges: high strength (originating from latrines and unsewered public toilets) and low strength (originating from Septic Tanks (S9)). High strength sludge is still rich in organics and has not undergone significant degradation, which makes it difficult to dewater. Low strength sludge has undergone significant anaerobic degradation and is more easily dewatered.

In order to be properly dried, high strength sludges must first be stabilized. Allowing the high strength sludge to degrade anaerobically in Settling/Thickening Ponds can do this. The same type of pond can be used to thicken low strength sludge, although it undergoes less degradation and requires more time to settle. The degradation process may actually hinder the settling of

low strength sludge because the gases produced bubble up and re-suspend the solids. To achieve maximum efficiency, the loading and resting period should not exceed 4 to 5 weeks, although much longer cycles are common. When a 4-week loading, and 4-week resting cycle is used, total solids (TS) can be increased to 14% (depending on the initial concentration).

As the sludge settles and digests, the supernatant must be decanted and treated separately. The thickened sludge can then go on to be dried or composted further.

**Adequacy** Settling/Thickening Ponds are appropriate where there is inexpensive, available space that is far from homes and businesses; it should be on the edge of the community.

The sludge is not hygienized and requires further treatment before disposal. Ideally this technology should be coupled with an onsite Drying (T13) or Co-Composting (T14) facility to generate a hygienic product.

Trained staff for operation and maintenance is required to ensure proper functioning.

This is a low-cost option that can be installed in most hot and temperate climates. Excessive rain may prevent the sludge from properly settling and thickening.

**Health Aspects/Acceptance** The incoming sludge is pathogenic, so workers should be equipped with proper protection (boots, gloves, and clothing). The thickened sludge is also infectious, although it is easier to handle and less prone to splashing and spraying. The pond may cause a nuisance for nearby residents due to bad odours and the presence of flies. Therefore, the pond should be located sufficiently away from urban centres.

**Maintenance** Maintenance is an important aspect of a well-functioning pond, although it is not intensive. The discharging area must be maintained and kept clean to reduce the potential for disease transmission and nuisance (flies and odours). Grit, sand, and solid waste that are discharged along with the sludge must be removed.

The thickened sludge must be removed mechanically (front end loader or specialized equipment) when the sludge has thickened sufficiently.

#### **Pros & Cons:**

- + Can be built and repaired with locally available materials
- + Low capital cost; low operating cost
- + Potential for local job creation and income generation
- + No electrical energy required
- Requires large land area
- Odours and flies are normally noticeable
- Long storage times
- Requires front-end loader for monthly desludging
- Requires expert design and operation

#### **References**

---

- \_ Heinss, U., Larmie, SA. and Strauss, M. (1999). *Characteristics of Faecal Sludges and their Solids-Liquid Separation*. Eawag/Sandec Report, Dübendorf, Switzerland. Available: [www.sandec.ch](http://www.sandec.ch)
- \_ Heinss, U., Larmie, SA. and Strauss, M. (1998). *Solids Separation and Pond Systems for the Treatment of Faecal Sludges in the Tropics-Lessons Learnt and Recommendations for Preliminary Design. Second Edition*. Eawag/Sandec Report 05/98, Dübendorf, Switzerland. Available: [www.sandec.ch](http://www.sandec.ch)
- \_ Montangero, A. and Strauss, M. (2002). *Faecal Sludge Treatment*. Lecture Notes, IHE Delft. Available: [www.sandec.ch](http://www.sandec.ch)

## T.12 Unplanted Drying Beds

Applicable to:  
System 1, 5, 6, 7, 8

T.12

Application Level	Management Level	Inputs:
<input type="checkbox"/> Household <input checked="" type="checkbox"/> Neighbourhood <input checked="" type="checkbox"/> City	<input type="checkbox"/> Household <input type="checkbox"/> Shared <input checked="" type="checkbox"/> Public	<input checked="" type="checkbox"/> Faecal Sludge
		<b>Outputs:</b> <input checked="" type="checkbox"/> Faecal Sludge <input checked="" type="checkbox"/> Effluent

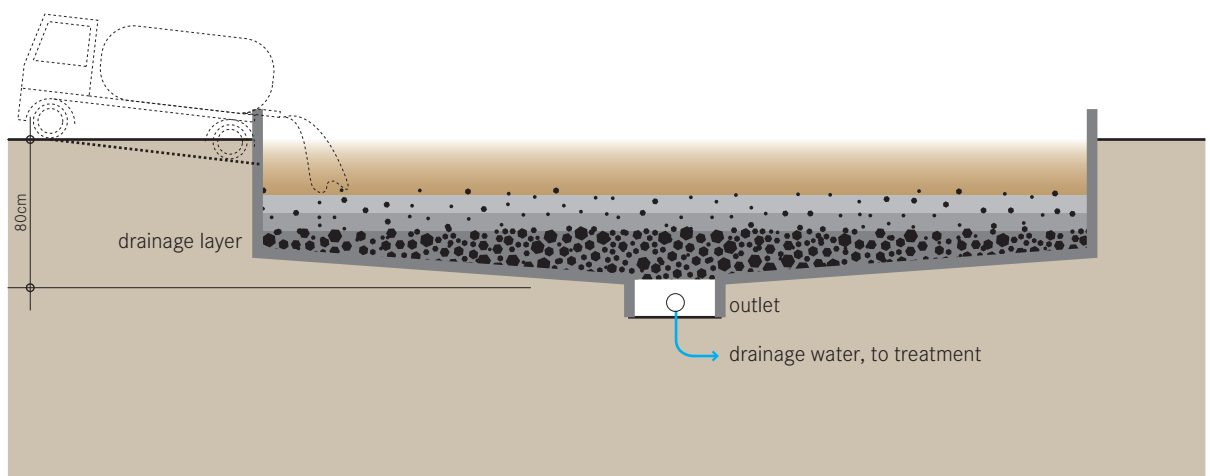

**An Unplanted Drying Bed is a simple, permeable bed that, when loaded with sludge, collects percolated leachate and allows the sludge to dry by evaporation. Approximately 50% to 80% of the sludge volume drains off as liquid. The sludge however, is not stabilized or treated.**

The bottom of the drying bed is lined with perforated pipes that drain away the leachate. On top of the pipes are layers of sand and gravel that support the sludge and allow the liquid to infiltrate and collect in the pipe. The sludge should be loaded to approximately 200kg TS/m<sup>2</sup> and it should not be applied in layers that are too thick (maximum 20 cm), or the sludge will not dry effectively. The final moisture content after 10 to 15 days of drying should be approximately 60%. A splash plate should be used to prevent erosion of the sand layer and to allow the even distribution of the sludge.

When the sludge is dried, it must be separated from the sand layer and disposed of. The effluent that is collected in the drainage pipes must also be treated properly. The top sand layer should be 25 to 30 cm thick as some sand will be lost each time the sludge is manually removed.

**Adequacy** Sludge drying is an effective way of decreasing the volume of sludge, which is especially important when it requires transportation elsewhere for direct use, Co-Composting (T14), or disposal. The technology is not effective at stabilizing the organic fraction or decreasing the pathogenic content.

Sludge drying beds are appropriate for small to medium communities with populations up to 100,000 people and there is inexpensive, available space that is far from homes and businesses. It is best suited to rural and peri-urban areas. If it is designed to service urban areas, it should be on the edge of the community.

The sludge is not hygienized and requires further treatment before disposal. Ideally this technology should be coupled with a Co-Composting (T14) facility to generate a hygienic product.

Trained staff for operation and maintenance is required to ensure proper functioning.

This is a low-cost option that can be installed in most hot and temperate climates. Excessive rain may prevent the sludge from properly settling and thickening.

**Health Aspects/Acceptance** The incoming sludge is pathogenic, so workers should be equipped with proper protection (boots, gloves, and clothing). The thickened sludge is also infectious, although it is easier to handle and less prone to splashing and spraying.

The pond may cause a nuisance for nearby residents due to bad odours and the presence of flies. Therefore, the pond should be located sufficiently away from urban centres.

**Maintenance** The Unplanted Drying Bed should be designed with maintenance in mind; access for humans and trucks to pump in the sludge and remove the dried sludge should be taken into consideration.

Dried sludge must be removed every 10 to 15 days. The discharge area must be kept clean and the effluent drains should be flushed regularly. Sand must be replaced when the layer gets thin.

#### **Pros & Cons:**

- + Can be built and repaired with locally available materials
- + Moderate Capital Cost; low operating Cost
- + Potential for local job creation and income generation
- + No electrical energy required
- Requires large land area
- Odours and flies are normally noticeable
- Long storage times
- Requires expert design and operation
- Labour intensive removal
- Leachate requires secondary treatment

#### **References**

---

- \_ Crites, R. and Tchobanoglous, G. (1998). *Small and Decentralized Wastewater Management Systems*. WCB and McGraw-Hill, New York, USA.
- \_ Heinss, U. and Koottatep, T. (1998). *Use of Reed Beds for Faecal Sludge Dewatering – A Synopsis of Reviewed Literature and Interim Results of Pilot Investigations with Septage Treatment in Bangkok, Thailand*. UEEM Program Report, AIT/EAWAG, Dübendorf, Switzerland. (Comparison to planted drying beds.)
- \_ Montangero, A. and Strauss, M. (2002). *Faecal Sludge Treatment*. Lecture Notes, IHE Delft. Available: [www.sandec.ch](http://www.sandec.ch)
- \_ Tchobanoglous, G., Burton, F.L. and Stensel, H.D. (2003). *Wastewater Engineering: Treatment and Reuse, 4th Edition*. Metcalf & Eddy, New York.

## T.13 Planted Drying Beds

Applicable to:  
System 1, 5, 6, 7, 8

T.13

### Application Level

- Household
- Neighbourhood
- City

### Management Level

- Household
- Shared
- Public

**Inputs:**  Faecal Sludge

**Outputs:**  Treated Sludge  Effluent  
 Forage

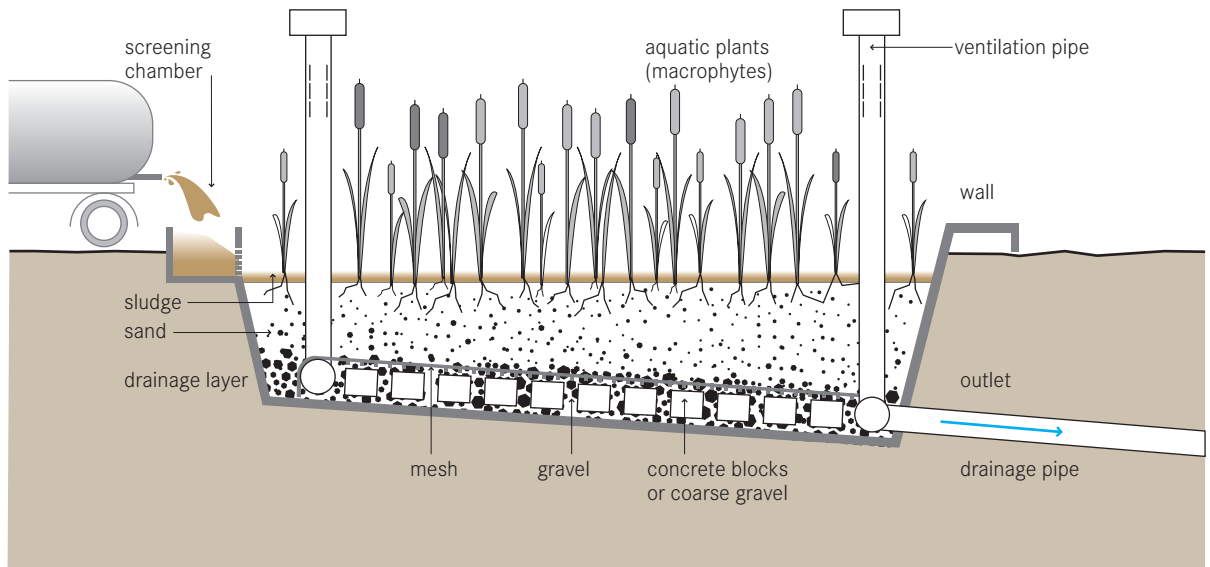

A Planted Drying Bed is similar to an Unplanted Drying Bed (T12) with the benefit of increased transpiration. The key feature is that the filters do not need to be desludged after each feeding/drying cycle. Fresh sludge can be applied directly onto the previous layer; it is the plants and their root systems that maintain the porosity of the filter.

This technology has the benefit of dewatering as well as stabilizing the sludge. Also, the roots of the plants create pathways through the thickening sludge to allow water to escape more easily.

The appearance of the bed is similar to a Vertical Flow Constructed Wetland (T7). The beds are filled with sand and gravel to support the vegetation. Instead of effluent, sludge is applied to the surface and the filtrate flows down through the subsurface to collect in drains. A general design for layering the bed is: (1) 250mm of coarse gravel (grain diameter of 20mm); (2) 250mm of fine gravel (grain diameter of 5 mm); and (3) 100–150mm of sand. Free space (1m) should be left above the top of the sand layer to account for about 3 to 5 years of accumulation.

When the bed is constructed, the plants should be planted evenly and allowed to establish themselves before the sludge is applied. *Echinochloa pyramidalis*, Cattails or *Phragmites* are suitable plants depending on the climate.

Sludge should be applied in layers between 75 to 100mm and should be reapplied every 3 to 7 days depending on the sludge characteristics, the environment and operating constraints. Sludge application rates of up to 250kg/m<sup>2</sup>/year have been reported.

The sludge can be removed after 2 to 3 years (although the degree of hygienization will vary with climate) and used for agriculture.

**Adequacy** This is an effective technology at decreasing sludge volume (down to 50%) through decomposition and drying, which is especially important when the sludge needs to be transported elsewhere for direct use, Co-Composting (T14), or disposal.

Planted drying beds are appropriate for small to medium communities with populations up to 100,000 people. It should be located on the edge of the community. The sludge is not hygienized and requires further treat-

ment before disposal. Ideally this technology should be coupled with a Co-Composting (T14) facility to generate a hygienic product.

Trained staff for operation and maintenance is required to ensure proper functioning.

**Health Aspects/Acceptance** Because of the pleasing aesthetics, there should be few problems with acceptance, especially if located away dense housing. Faecal sludge is hazardous and anyone working with it should wear protective clothing, boots and gloves.

**Maintenance** The drains must be maintained and the effluent must be properly collected and disposed of. The plants should be periodically thinned and/or harvested.

#### Pros & Cons:

- + Can handle high loading
- + Fruit or forage growing can generate income
- + Can be built and repaired with locally available materials
- + Low capital cost; low operating cost
- + Potential for local job creation and income generation
- + No electrical energy required
- Requires large land area
- Odours and flies are normally noticeable
- Long storage times
- Requires expert design and operation
- Labour intensive removal
- Leachate requires secondary treatment

#### References

- \_ Crites, R. and Tchobanoglous, G. (1998). *Small and Decentralized Wastewater Management Systems*. WCB and McGraw-Hill, New York, USA.
- \_ Heinss, U. and Koottatep, T. (1998). *Use of Reed Beds for Faecal Sludge Dewatering - A Synopsis of Reviewed Literature and Interim Results of Pilot Investigations with Septage Treatment in Bangkok, Thailand*. UEEM Program Report, AIT/EAWAG, Dübendorf, Switzerland. Available: [www.sandec.ch](http://www.sandec.ch)
- \_ Koottatep, T., et al. (2004). Treatment of septage in constructed wetlands in tropical climate - Lessons learnt after seven years of operation. *Water Science & Technology*, 51(9): 119-126. Available: [www.sandec.ch](http://www.sandec.ch)
- \_ Montangero, A. and Strauss, M. (2002). *Faecal Sludge Treatment*. Lecture Notes, IHE Delft. Available: [www.sandec.ch](http://www.sandec.ch)
- \_ Tchobanoglous, G., Burton, F.L. and Stensel, H.D. (2003). *Wastewater Engineering: Treatment and Reuse, 4th Edition*. Metcalf & Eddy, New York, pp 1578.
- \_ Kengne Noumsi, IM. (2008). *Potentials of Sludge drying beds vegetated with Cyperus papyrus L. and Echinochloa pyramidalis (Lam.) Hitchc. & Chase for faecal Sludge treatment in tropical regions*. [PhD dissertation]. Yaounde (Cameroon): University of Yaounde. Available: [www.nccr-north-south.unibe.ch](http://www.nccr-north-south.unibe.ch)

<b>Application Level</b> <input type="checkbox"/> Household <input checked="" type="checkbox"/> Neighbourhood <input checked="" type="checkbox"/> City	<b>Management Level</b> <input type="checkbox"/> Household <input checked="" type="checkbox"/> Shared <input checked="" type="checkbox"/> Public	<b>Inputs:</b> <input checked="" type="checkbox"/> Faecal Sludge <input checked="" type="checkbox"/> Organics
		<b>Outputs:</b> <input checked="" type="checkbox"/> Compost/EcoHumus

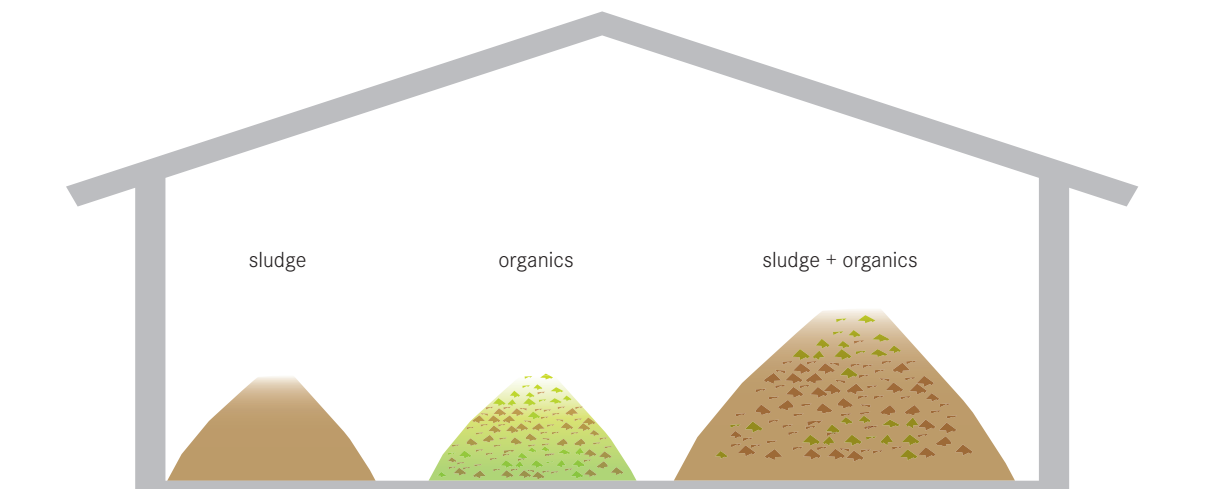

**Co-Composting is the controlled aerobic degradation of organics using more than one feedstock (Faecal sludge and Organic solid waste). Faecal sludge has a high moisture and nitrogen content while biodegradable solid waste is high in organic carbon and has good bulking properties (i.e. it allows air to flow and circulate). By combining the two, the benefits of each can be used to optimize the process and the product.**

For dewatered sludges, a ratio of 1:2 to 1:3 of dewatered sludge to solid waste should be used. Liquid sludges should be used at a ratio of 1:5 to 1:10 of liquid sludge to solid waste.

There are two types of Co-Composting designs: open and in-vessel. In open composting, the mixed material (sludge and solid waste) is piled into long heaps called windrows and left to decompose. Windrow piles are turned periodically to provide oxygen and ensure that all parts of the pile are subjected to the same heat treatment. Windrow piles should be at least 1 m high, and should be insulated with compost or soil to promote an even distribution of heat inside the pile. Depending on the climate and available space, the facility may be covered to prevent excess evaporation and protection from rain.

In-vessel composting requires controlled moisture and air supply, as well as mechanical mixing. Therefore, it is not generally appropriate for decentralized facilities. Although the composting process seems like a simple, passive technology, a well-working facility requires careful planning and design to avoid failure.

**Adequacy** A Co-Composting facility is only appropriate when there is an available source of well-sorted biodegradable solid waste. Mixed solid waste with plastics and garbage must first be sorted. When done carefully, Co-Composting can produce a clean, pleasant, beneficial product that is safe to touch and work with. It is a good way to reduce the pathogen load in sludge.

Depending on the climate (rainfall, temperature and wind) the Co-Composting facility can be built to accommodate the conditions. Since moisture plays an important role in the composting process, covered facilities are especially recommended where there is heavy rainfall. The facility should be located close to the sources of organic waste and faecal sludge (to minimize transport) but to minimize nuisances, it should not be too close to homes and businesses.



A well-trained staff is necessary for the operation and maintenance of the facility.

**Health Aspects/Acceptance** Although the finished compost can be safely handled, care should be taken when handling the faecal sludge. Workers should wear protective clothing and appropriate respiratory equipment if the material is found to be dusty.

**Upgrading** Robust grinders for shredding large pieces of solid waste (i.e. small branches and coconut shells) and pile turners help to optimize the process, reduce manual labour, and ensure a more homogenous end product.

**Maintenance** The mixture must be carefully designed so that it has the proper C:N ratio, moisture and oxygen content. If facilities exist, it would be useful to monitor helminth egg inactivation as a proxy measure of sterilization. Maintenance staff must carefully monitor the quality of the input materials, keep track of the inflows, outflows, turning schedules, and maturing times to ensure a high quality product. Manual turning must be done periodically with either a front-end loader or by hand. Forced aeration systems must be carefully controlled and monitored.

#### Pros & Cons:

- + Easy to set up and maintain with appropriate training
- + Provides a valuable resource that can improve local agriculture and food production
- + High removal of helminth eggs possible (< 1 egg viable egg/g TS)
- + Can be built and repaired with locally available materials
- + Low capital cost; low operating cost
- + Potential for local job creation and income generation
- + No electrical energy required
- Long storage times
- Requires expert design and operation
- Labour intensive
- Requires large land area (that is well located)

#### References

- \_ Cofie, O., et al. (2006). Solid-liquid separation of faecal Sludge using drying beds in Ghana: Implications for nutrient recycling in urban agriculture. *Water Research* 40(1): 75-82.
  - \_ Koné, D., et al. (2007). Helminth eggs inactivation efficiency by faecal Sludge dewatering and co-composting in tropical climates. *Water Research* 41(19): 4397-4402.
  - \_ Obeng, L.A. and Wright, F.W. (1987). *Integrated Resource Recover. The Co-Composting of Domestic Solid and Human Wastes.* The World Bank + UNDP, Washington.
  - \_ Shuval, H.I., et al. (1981). *Appropriate Technology for Water Supply and Sanitation; Night-soil Composting.* UNDP/WB Contribution to the IDWSSD. The World Bank, Washington.
- The following reports can all be found in the Faecal Sludge Co-Composting section of the Sandec Website: [www.sandec.ch](http://www.sandec.ch)
- \_ Montangero, A., et al. (2002). *Co-composting of Faecal Sludge and Soil Waste.* Sandec/IWMI, Dübendorf, Switzerland.
  - \_ Strauss, M., et al. (2003). *Co-composting of Faecal Sludge and Municipal Organic Waste- A Literature and State-of-Knowledge Review.* Sandec/IMWI, Dübendorf, Switzerland.
  - \_ Drescher, S., Zurbrügg, C., Enayetullah, I. and Singha, MAD. (2006). *Decentralised Composting for Cities of Low- and Middle-Income Countries - A User's Manual.* Eawag/Sandec and Waste Concern, Dhaka.

## T.15 Anaerobic Biogas Reactor

Applicable to:  
System 1, 5, 6, 7, 8

T.15

### Application Level

- ★★ Household
- ★★ Neighbourhood
- ★★ City

### Management Level

- ★★ Household
- ★★ Shared
- ★★ Public

**Inputs:**  Faecal Sludge  Blackwater  
 Organics

**Outputs:**  Treated Sludge  Effluent  
 Biogas

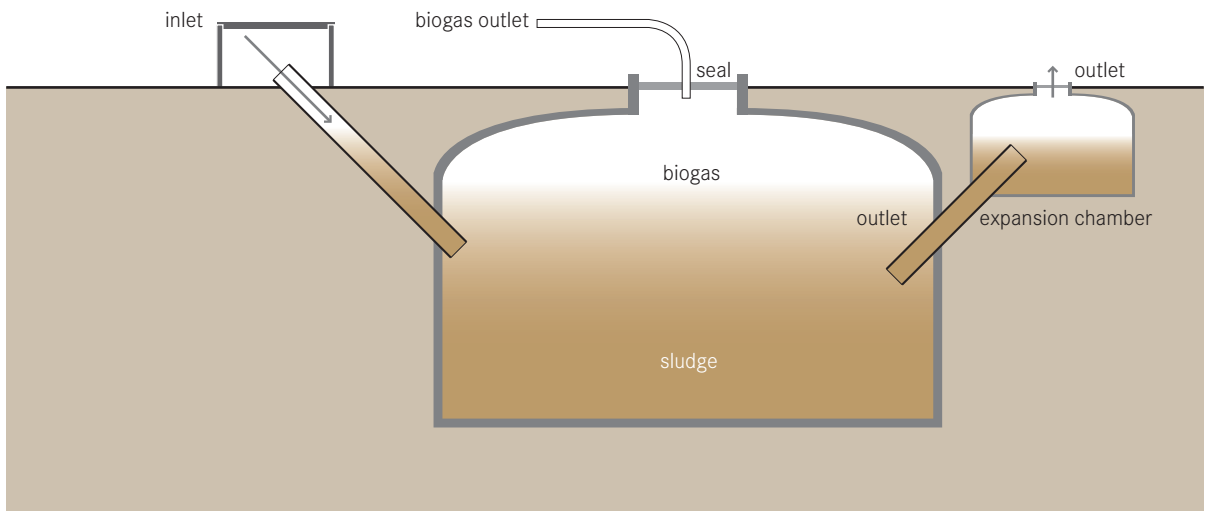

**An Anaerobic Biogas Reactor is an anaerobic treatment technology that produces (a) a digested slurry to be used as a soil amendment and (b) biogas which can be used for energy. Biogas is a mix of methane, carbon dioxide and other trace gases that can be easily converted to electricity, light and heat.**

An Anaerobic Biogas Reactor is a chamber or vault that facilitates the anaerobic degradation of blackwater, sludge, and/or biodegradable waste. It also facilitates the separation and collection of the biogas that is produced. The tanks can be built above or below ground. Prefabricated tanks or brick-constructed chambers can be built depending on space, resources and the volume of waste generated.

The hydraulic retention time (HRT) in the reactor should be a minimum of 15 days in hot climates and 25 days in temperate climates. For highly pathogenic inputs, a HRT of 60 days should be considered. Normally, Anaerobic Biogas Reactors are not heated, but to ensure pathogen destruction (i.e. a sustained temperature over 50°C) the reactor should be heated (although in practice, this is only found in the most industrialized countries).

Once waste products enter the digestion chamber, gases are formed through fermentation. The gas forms in the sludge but collects at the top of the reactor, mixing the slurry as it rises. Biogas Reactors can be built as fixed dome or floating dome reactors. In the fixed dome reactor the volume of the reactor is constant. As gas is generated it exerts a pressure and displaces the slurry into an expansion chamber. When the gas is removed, the slurry will flow back down into the digestion chamber. The pressure generated can be used to transport the biogas through pipes. In a floating dome reactor, the dome will rise and fall with the production and withdrawal of gas. Alternatively, the dome can expand (like a balloon).

Most often Biogas Reactors are directly connected to indoor (private or public) toilets with an additional access point for organic materials. At the household level, reactors can be made out of plastic containers or bricks and can be built behind the house or buried underground. Sizes can vary from 1,000L for a single family up to 100,000L for institutional or public toilet applications.

The slurry that is produced is rich in organics and nutrients, but almost odourless and partly disinfected (com-

plete pathogen destruction would require thermophilic conditions). Often, a Biogas Reactor is used as an alternative to a conventional septic tank, since it offers a similar level of treatment, but with the added benefit of energy capture. Depending on the design and the inputs, the reactor should be emptied once every 6 months to 10 years.

**Adequacy** This technology is easily adaptable and can be applied at the household level or a small neighbourhood (refer to Technology Information Sheet S12: Anaerobic Biogas Reactor for information about applying an Anaerobic Biogas Reactor at the household level).

Biogas reactors are best used for concentrated products (i.e. rich in organic material). If they are installed at a public toilet, for example, and the sludge is too dilute, additional organic waste (e.g. from the market) can be added to improve the efficiency. Because they are compact and can be built underground, biodigestors are appropriate for dense housing areas or public institutions that generate a lot of sludge, but where space is limited.

To minimize distribution losses, the reactors should be installed close to where the gas can be used.

Biogas reactors are less appropriate for colder climates as gas production is not economically feasible below 15°C.

**Health Aspects/Acceptance** The digested slurry is not completely sanitized and still carries a risk of infection. There are also dangers associated with the flammable gases that, if mismanaged could be harmful to human health.

**Maintenance** The Anaerobic Biogas Reactor must be well built and gas tight for safety. If the reactor is properly designed, repairs should be minimal. To start the reactor, active sludge (e.g. from a septic tank) should be used as a seed. The tank is essentially self-mixing, but it should be manually stirred once a week to prevent uneven reactions.

Gas equipment should be cleaned carefully and regularly so that corrosion and leaks are prevented.

Grit and sand that has settled to the bottom should be removed once every year. Capital costs for gas transmission infrastructure can increase the project cost. Depending on the quality of the output, the gas transmission capital costs can be offset by long-term energy savings.

#### Pros & Cons:

- + Generation of a renewable, valuable energy source
- + Low capital costs; low operating costs
- + Underground construction minimizes land use
- + Long life span
- + Can be built and repaired with locally available materials
- + Low capital cost; low operating cost
- + No electrical energy required
- Requires expert design and skilled construction
- Gas production below 15°C, is not longer economically feasible
- Digested sludge and effluent still requires further treatment

#### References

- \_ Food and Agriculture Organization (FAO) (1996). *Biogas Technology: A Training Manual for Extension*. Consolidated Management Services, Kathmandu. Available: [www.fao.org](http://www.fao.org)
- \_ ISAT (1998). *Biogas Digest Vols. I-IV*. ISAT and GTZ, Germany. Available: [www.gtz.de](http://www.gtz.de)
- \_ Koottatep, S., Ompong, M. and Joo Hwa, T. (2004). *Biogas: A GP Option For Community Development*. Asian Productivity Organization, Japan. Available: [www.apo-tokyo.org](http://www.apo-tokyo.org)
- \_ Rose, G.D. (1999). *Community-Based Technologies for Domestic Wastewater Treatment and Reuse: options for urban agriculture*. IDRC, Ottawa. pp 29–32. Available: <http://idrinfor.idrc.ca>
- \_ Sasse, L. (1998). *DEWATS: Decentralised Wastewater Treatment in Developing Countries*. BORDA, Bremen Overseas Research and Development Association, Bremen, Germany.

This section presents different technologies and methods that use or dispose of the output products in ways that are the least harmful to the user and the environment.



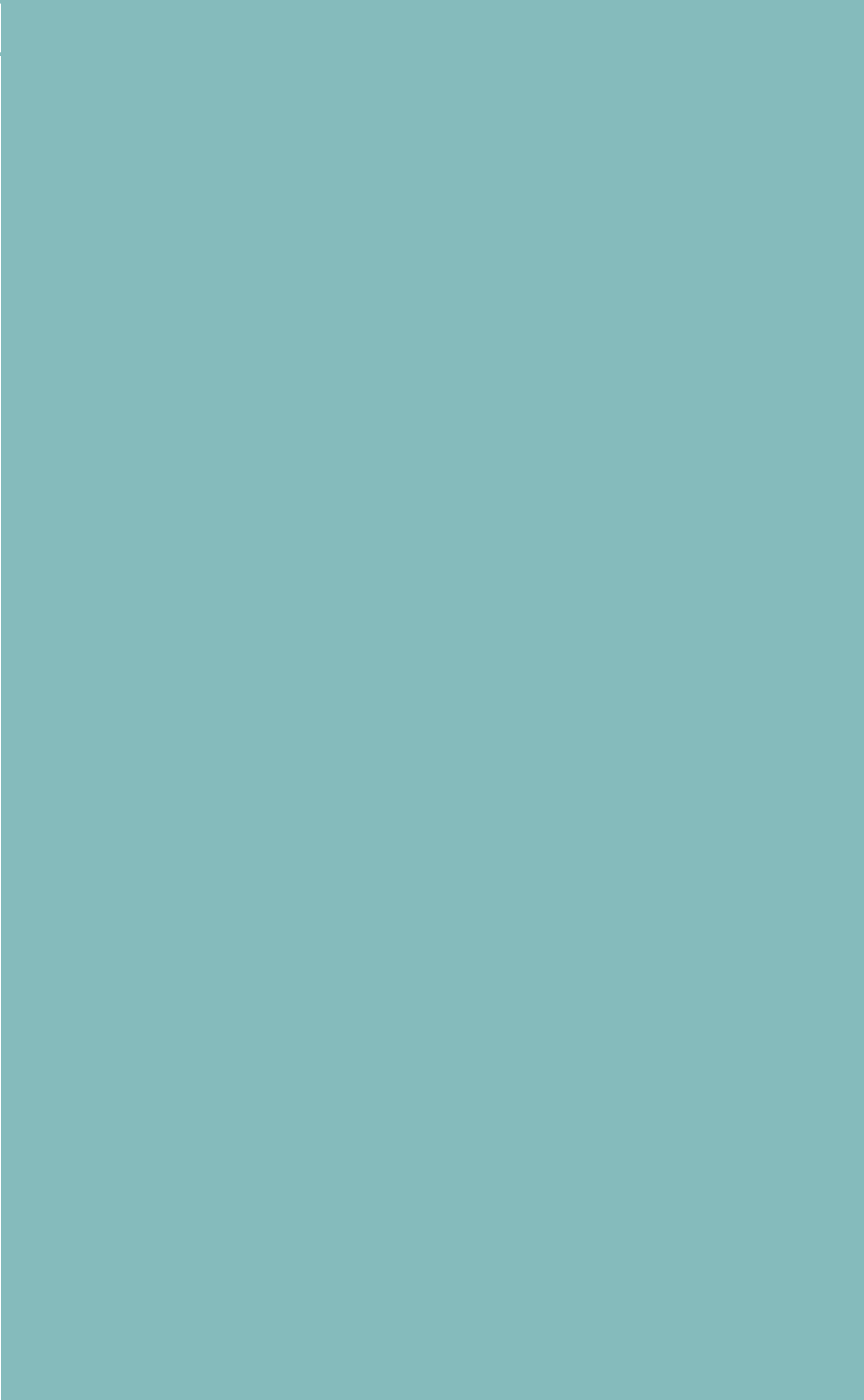

Application Level	Management Level	Inputs:
(★★) Household (★★) Neighbourhood ( ) City	(★★) Household (★) Shared ( ) Public	( ) Excreta    ( ) Faeces ( ) Compost/EcoHumus

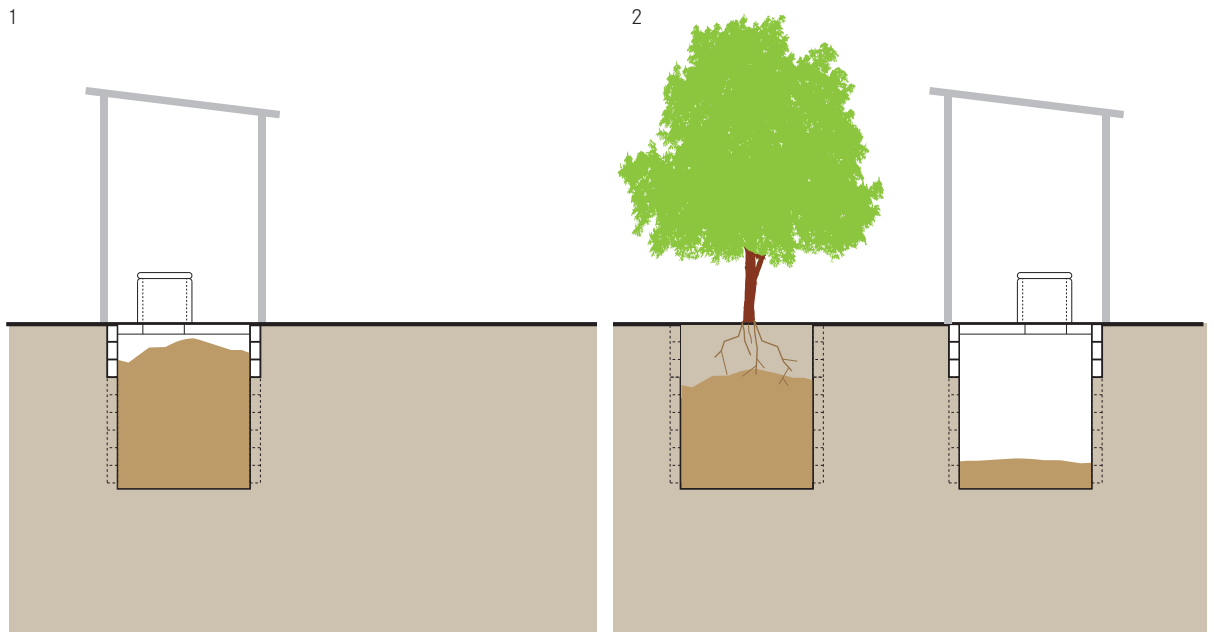

**To decommission a pit, it can simply be filled with soil and covered. Although there is no benefit recovered, the full pit poses no immediate health risk, and with time, the contents will degrade naturally. Alternatively, the ‘Arborloo’ is a shallow pit that is filled with excreta and soil/ash and then covered with soil; a tree planted on top will grow vigorously in the nutrient-rich pit.**

When a single pit or a single VIP is full, and can not be emptied, Fill and Cover, i.e. filling the remainder of the pit and covering it is an option, albeit one with limited benefits to the environment or the user.

In the Arborloo, a tree is planted on top of the full pit while the superstructure, ring beam and slab are continuously moved from pit to pit in an endless cycle (usually moved once every 6 to 12 months). A shallow pit is needed, about 1 m deep. The pit should not be lined as the lining would prevent the tree or plant from growing properly. Before the pit is used, a layer of leaves is put into the bottom. After each defecation, a cup of soil, ash or a mixture should be dumped into the pit to cover the excreta. If they are available, leaves can also be added occasionally to improve the porosity and

air content of the pile. When the pit is full, the top 15 cm of the pit is filled with soil and a tree is planted in the soil. Banana, papaya and guava trees (among many) have all proven to be successful. A tree should not be planted directly in the raw excreta. The tree starts to grow in the soil and its roots penetrate the composting pits as it grows. It may be best to wait for the rainy season before planting if water is scarce. Other plants such as tomatoes and pumpkins can also be planted on top of the pit if trees are not available.

**Adequacy** Filling and covering pits is an adequate solution when emptying is not possible and when there is space to continuously re-dig and fill pits.

The Arborloo can be applied in rural, peri-urban, and denser areas if space is available.

Planting a tree in the abandoned pit is a good way to reforest an area, provide a sustainable source of fresh fruit and prevent people from falling into old pit sites.

**Health Aspects/Acceptance** There is a minimal risk of infection if the pit is properly covered and clearly marked. It may be preferable to cover the pit and plant a tree rather than have the pit emptied, especial-

ly if there is no appropriate technology available for treating the faecal sludge.

Users do not come in contact with the faecal material and thus there is a very low risk of pathogen transmission. Demonstration projects that allow community members to participate are useful ways of showing both the ease of the system, its inoffensive nature, and the nutrient value of composted excreta.

**Maintenance** A cup of soil and/or ash should be added to the pit after each defecation and leaves should be added periodically. Also, the contents of the pit should be periodically levelled to prevent a cone-shape from forming in the middle of the pit.

There is little maintenance associated with a closed pit other than taking care of the tree or plant. If a tree is planted in the abandoned pit, it should be watered regularly. A small-fence should be constructed with sticks and sacks around the sapling to protect it from animals.

#### **Pros & Cons:**

- + Simple technique for all users
- + Low cost
- + Low risk of pathogen transmission
- + May encourage income generation (tree planting and fruit production)
- Labour intensive

#### **References**

---

- \_ Morgan, P. (2007). *Toilets that make compost*. Stockholm Environment Institute, Stockholm, Sweden. pp 81–90. Available: [www.ecosanres.org](http://www.ecosanres.org)
- \_ Morgan, P. (2004). *An Ecological Approach to Sanitation in Africa: A Compilation of Experiences*. Aquamor, Harare, Zimbabwe. Chapter 10 – The usefulness of urine. Available: [www.ecosanres.org](http://www.ecosanres.org)
- \_ NWP (2006). *Smart Sanitation Solutions. Examples of innovative, low-cost technologies for toilets, collection, transportation, treatment and use of sanitation products*. Netherlands Water Partnership, The Netherlands. pp 51.

Application Level	Management Level	Inputs:
<ul style="list-style-type: none"> <li>★★ Household</li> <li>★★ Neighbourhood</li> <li>★★ City</li> </ul>	<ul style="list-style-type: none"> <li>★★ Household</li> <li>★★ Shared</li> <li>★★ Public</li> </ul>	<ul style="list-style-type: none"> <li>Stored Urine</li> </ul>

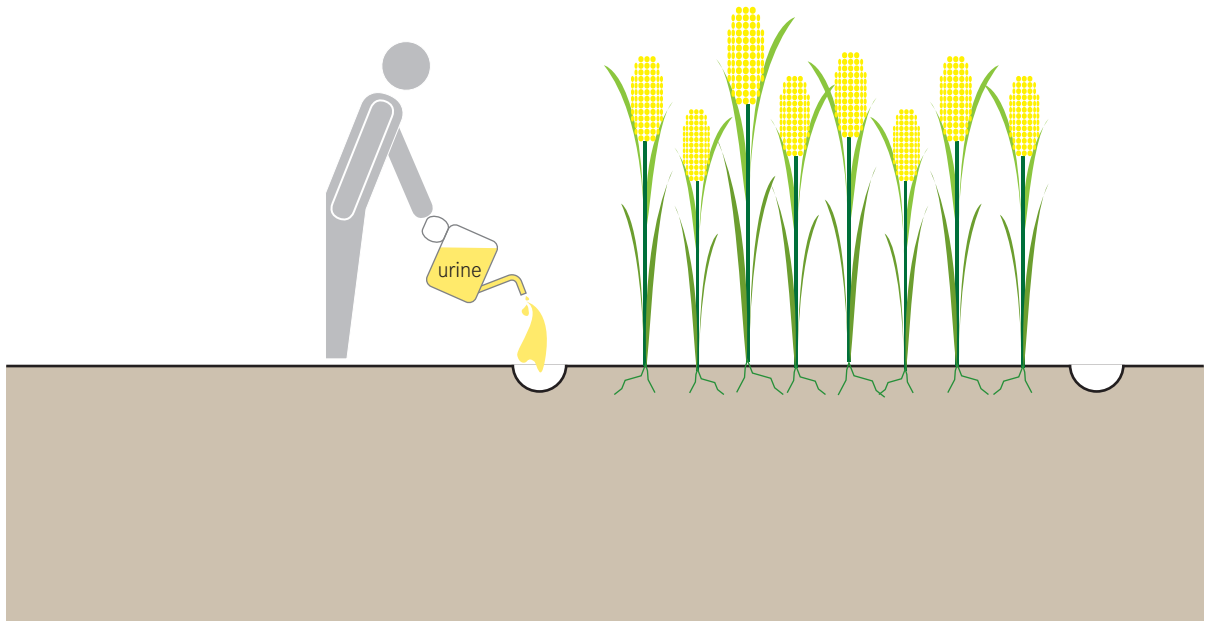

**Separately collected, stored urine is a concentrated source of nutrients that can be applied as a liquid fertilizer in agriculture to replace all or some commercial chemical fertilizer.**

The guidelines for urine use are based on storage time and temperature (please see WHO guidelines for specific requirements). However, it is generally accepted that if urine is stored for at least 1 month, it will be safe for agricultural application at the household level. If urine is used for crops that are eaten by those other than the urine producer, it should be stored for 6 months. Urine should not be applied to crops within one month before they are harvested.

From normal, healthy people, urine is virtually free of pathogens. Urine also contains the majority of nutrients that are excreted by the body. Urine varies depending on diet, gender, climate and water intake among other facts, but roughly 80% of nitrogen, 60% of potassium and 55% of phosphorus that is excreted from the body is excreted through urine.

Because of its high pH and concentration, stored urine should not be applied directly to plants. Rather it can be used:

- 1) mixed undiluted into soil before planting;
- 2) poured into furrows sufficiently away from plant roots and covered immediately (once or twice during the growing season); and
- 3) diluted several times and used frequently (twice weekly) poured around plants.

To calculate the application rate, one can assume that 1 m<sup>2</sup> of cropland can receive the urine from 1 person per day (1 to 1.5 L), per crop harvested (e.g. 400 m<sup>2</sup> of cropland per year can be fertilized). A 3:1 mix of water and urine is an effective dilution for vegetables, applied twice weekly, although the amount depends on the soil and the type of vegetables. During the rainy season, urine can also be applied directly into small holes near plants, where it will be diluted naturally.

**Adequacy** Urine is especially beneficial where crops are lacking nitrogen. Examples of some crops that grow well with urine include: maize, rice, millet, sorghum, wheat, chard, turnip, carrots, kale, cabbage, lettuce, bananas, paw-paw, and oranges.

Urine application is ideal for rural and peri-urban areas where agricultural lands are close to the point of urine collection. Households can use their own urine on their



own plot of land. Alternatively, if facilities and infrastructure exist, urine can be collected at a semi-centralized location for distribution and transport to agricultural land. Regardless, the most important aspect is that there is a need for nutrients otherwise, the urine can become a source of pollution and nuisance if dealt with improperly.

**Health Aspects/Acceptance** There is a minimal risk of infection, especially with extended storage. Still, urine should be handled carefully and should not be applied to crops less than one month before they are harvested.

Social acceptance may be difficult. Stored urine has a strong smell and some may find it offensive to work with or be near. If urine is diluted, and/or immediately tilled into the earth, the smells can be reduced. The use of urine may be less accepted in urban or peri-urban areas where household gardens are close to houses than in rural areas, where houses and crop lands are separated.

**Maintenance** With time, some minerals in urine will precipitate (especially calcium and magnesium phosphates). Any equipment that is used to collect, transport or apply urine (i.e. watering cans with small holes) may become clogged over time. Most deposits can easily be removed with hot water and a bit of acid (vinegar), or in more extreme cases, chipped off manually.

#### **Pros & Cons:**

- + Simple technique for all users
- + Low cost
- + Low risk of pathogen transmission
- + Reduces dependence on costly chemical fertilizers
- + May encourage income generation (tree planting and fruit production)
- Urine is heavy and difficult to transport
- Smell may be offensive
- Labour intensive

#### **References**

- \_ Austin, A. and Duncker, L. (2002). *Urine-diversion. Ecological Sanitation Systems in South Africa*. CSIR, Pretoria, South Africa.
- \_ GTZ (2005). *Technical data sheets for ecosan components-01 Urine Diversion*. GTZ, Germany. Available: [www.gtz.de](http://www.gtz.de)
- \_ Morgan, P. (2007). *Toilets that make compost*. Stockholm Environment Institute, Stockholm, Sweden. Available: [www.ecosanres.org](http://www.ecosanres.org)
- \_ Morgan, P. (2004). *An Ecological Approach to Sanitation in Africa: A Compilation of Experiences*. Aquamor, Harare, Zimbabwe. Chapter 10 – The usefulness of urine. Available: [www.ecosanres.org](http://www.ecosanres.org)
- \_ NWP (2006). *Smart Sanitation Solutions. Examples of innovative, low-cost technologies for toilets, collection, transportation, treatment and use of sanitation products*. Netherlands Water Partnership, The Netherlands. pp 51.
- \_ Schonning, C. and Stenstrom, TA. (2004). *Guidelines for the Safe Use of Urine and Faeces in Ecological Sanitation Systems-Report 2004-1*. EcosanRes, Stockholm Environment Institute, Stockholm, Sweden. Available: [www.ecosanres.org](http://www.ecosanres.org)
- \_ Winblad, U. and Simpson-Herbert, M. (eds.) (2004). *Ecological Sanitation- revised and enlarged edition*. Stockholm Environment Institute, Stockholm, Sweden. Available: [www.ecosanres.org](http://www.ecosanres.org)
- \_ WHO (2006). *Guidelines for the safe use of wastewater, excreta and greywater - Volume 4: Excreta and greywater use in agriculture*. WHO, Geneva. Available: [www.who.int](http://www.who.int)

Application Level	Management Level	Inputs:
<input checked="" type="checkbox"/> Household <input checked="" type="checkbox"/> Neighbourhood <input type="checkbox"/> City	<input checked="" type="checkbox"/> Household <input checked="" type="checkbox"/> Shared <input checked="" type="checkbox"/> Public	<input checked="" type="checkbox"/> Dried Faeces

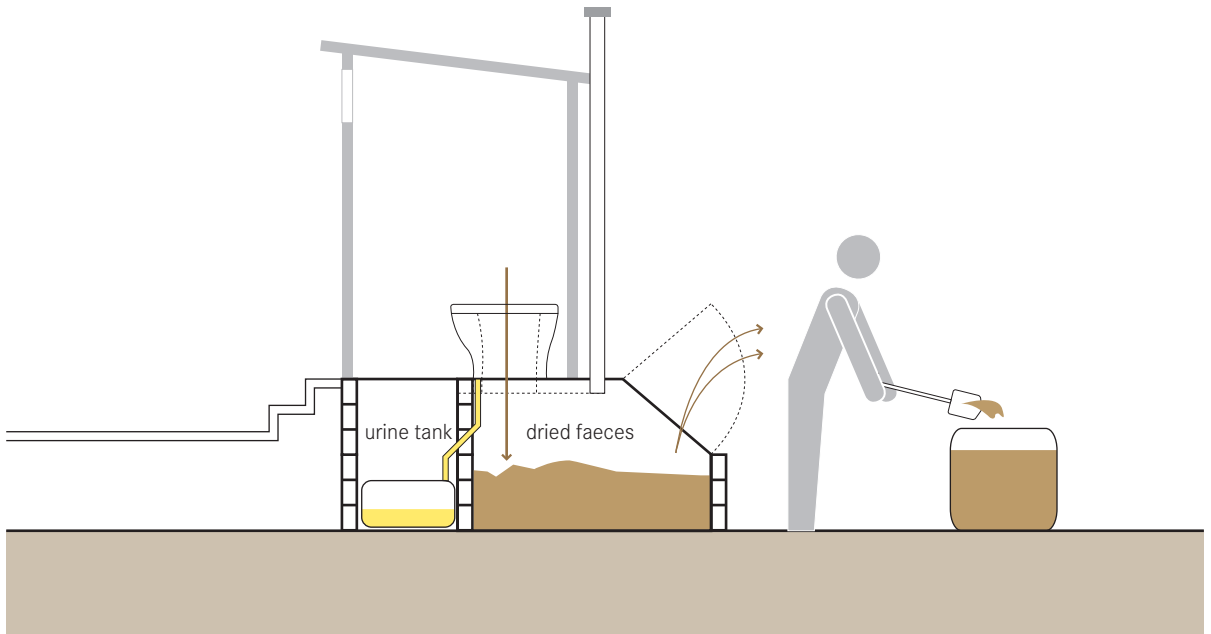

**When faeces are stored in the absence of moisture (i.e. urine) they dehydrate into a crumbly, white-beige coarse, flaky material or powder. Dehydration means that the moisture naturally present in the faeces evaporates and/or is absorbed by the addition of a drying material (e.g. ash, sawdust, lime).**

Dehydration is different from composting because the organic material present is not degraded or transformed; only the moisture is removed. After dehydration, faeces will reduce in volume by about 75%. The shells and carcasses of worms and insects that also dehydrate will remain in the dried faeces.

The degree of pathogen inactivation will depend on the temperature, the pH (e.g. lime raises the pH) and storage time. It is generally accepted that faeces should be stored between 12 to 18 months, although pathogens may still exist after this time.

When the faeces are completely dry they will emerge as a crumbly, powdery substance. The material is rich in carbon and nutrients, but may still contain pathogens or oocysts (spores which can survive extreme environmental conditions and re-animate under favourable conditions). The material can be mixed into

soil, either for agriculture or at another site (depending on acceptance).

Faeces that are dried and stored between 2 and 20°C should be stored for between 1.5 to 2 years before they are used at the household or regional level. At higher temperatures (i.e. greater than 20°C) storage over one year is recommended to inactivate *Ascaris* eggs (a type of parasitic worm). A shorter storage time of six months is required if the faeces have a pH above 9 (i.e. lime will increase the pH of the faeces). The WHO has published guidelines and these should be consulted before using dried faeces.

**Adequacy** Dried faeces are not as well treated or as useful as a soil amendment as composted faeces. However, they are useful at replenishing poor soils and for boosting the carbon and water-storing properties of a soil with low-risk of pathogen transmission.

**Health Aspects/Acceptance** The handling and use of dried faeces may not be acceptable to some. However, because the dried faeces should be dry, crumbly, and odour free, the use of dried faeces may be more acceptable than that of manure or sludge. Dry

faeces are a hostile environment for organisms and consequently, they do not survive (for long). If water or urine mixes with the drying faeces, odours and organisms may become problematic; wet faeces allow bacteria to survive and multiply. A warm, moist environment will permit anaerobic processes to generate offensive odours.

When removing the dehydrated faeces from the dehydration vaults, care must be taken to prevent the power from blowing and being inhaled.

**Maintenance** Faeces should be kept as dry as possible. If by accident, water or urine enters mixes with the drying faeces, more ash, lime or dry soil can be added to help absorb the moisture. Prevention is the best way of keeping the faeces dry.

#### **Pros & Cons:**

- + Can improve the structure and water-holding capacity of soil
- + Simple technique for all users
- + Low cost
- + Low risk of pathogen transmission
- + May encourage income generation (tree planting and fruit production)
- Labour intensive
- Pathogens may exist in a dormant stage (oocysts) which may become infectious if moisture is added
- Does not replace fertilizer (N, P, K)

#### **References**

---

- \_ Austin, A. and Duncker, L. (2002). *Urine-diversion. Ecological Sanitation Systems in South Africa*. CSIR, Pretoria.
- \_ Schonning, C. and Stenstrom, TA. (2004). *Guidelines for the Safe Use of Urine and Faeces in Ecological Sanitation Systems-Report 2004-1*. EcosanRes, Stockholm Environment Institute, Stockholm, Sweden. Available: [www.ecosanres.org](http://www.ecosanres.org)
- \_ WHO (2006). *Guidelines for the safe use of wastewater, excreta and greywater - Volume 4: Excreta and greywater use in agriculture*. WHO, Geneva. Available: [www.who.int](http://www.who.int)
- \_ Winblad, U. and Simpson-Herbert, M. (eds.) (2004). *Ecological Sanitation- revised and enlarged edition*. Stockholm Environment Institute, Stockholm, Sweden. Available: [www.ecosanres.org](http://www.ecosanres.org)

Application Level	Management Level	Inputs:
<input checked="" type="checkbox"/> Household <input checked="" type="checkbox"/> Neighbourhood <input type="checkbox"/> City	<input checked="" type="checkbox"/> Household <input checked="" type="checkbox"/> Shared <input type="checkbox"/> Public	<input checked="" type="checkbox"/> Compost/EcoHumus

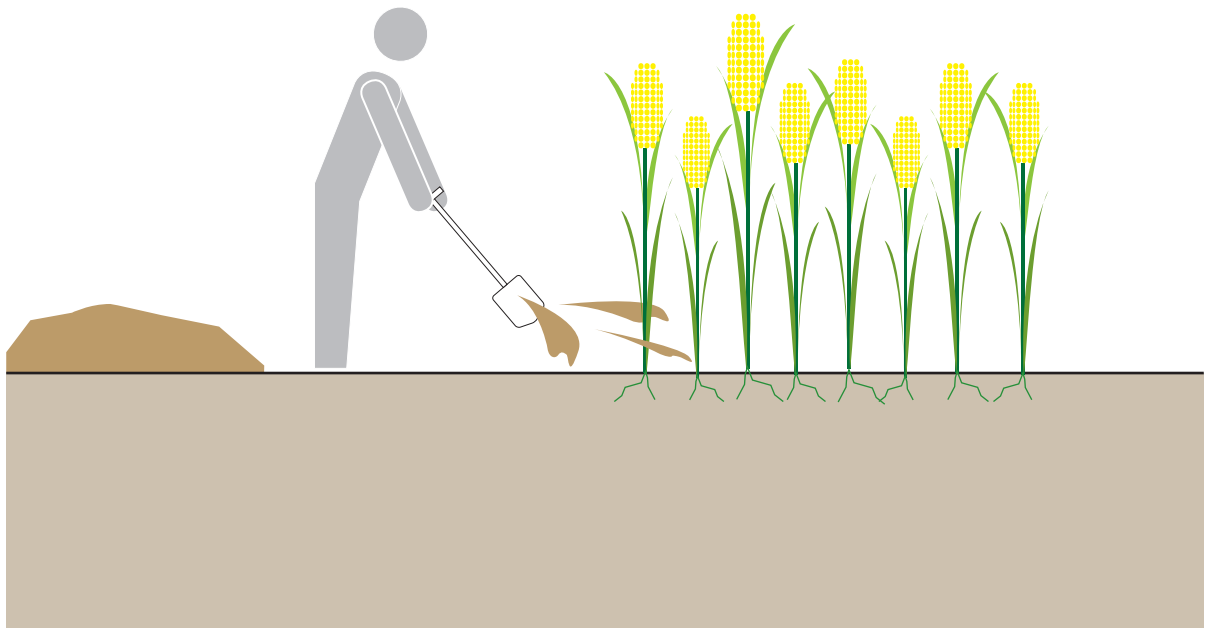

**Composting is the term used to describe the controlled aerobic degradation of organics into a soil-like substance called compost. ‘EcoHumus’ is a term taken from Peter Morgan (see references) and is a more appropriate word to use for the material removed from a Fossa Alterna because it is produced passively underground and has a slightly different composition.**

The process of thermophilic composting generates heat (50 to 80 °C) which kills the majority of pathogens present. For the composting process to occur there must be adequate carbon, nitrogen, moisture, and air.

The Fossa Alterna (S5) and Arborloo (D1) are ambient-temperature variations of high-temperature composting. In these technologies, there is almost no temperature rise because vegetable matter is lacking. For that reason, the material is not actually ‘compost’ and is therefore referred to as ‘EcoHumus’.

The WHO guidelines stipulate that the compost should achieve and maintain a temperature of 50 °C for at least one week before it is considered safe (although to achieve this value, a significantly longer period of composting is required). The WHO guidelines should be

consulted for detailed information. For systems that generate EcoHumus in-situ (i.e. Fossa Alterna), a minimum of 1 year of storage is recommended to eliminate bacterial pathogens and reduce viruses and parasitic protozoa.

Compost/EcoHumus can be used beneficially to improve the quality of soils by adding nutrients and organics and improving the soil’s ability to store air and water. The texture and quality of the EcoHumus depends on the materials which have been added to the excreta (especially the type of soil).

**Adequacy** Compost/EcoHumus can be mixed into the soil before crops are planted, used to start seedlings or indoor plants or simply mixed into an existing compost pile for further treatment.

For poor soils, equal parts of compost and top soil have shown to improve productivity. The output from one Fossa Alterna should be sufficient for two 1.5m by 3.5m beds. Vegetable gardens filled with the EcoHumus from the Fossa Alterna have shown dramatic improvements over gardens planted without compost, and has even made agriculture possible in areas which would have not otherwise supported crops.

**Health Aspects/Acceptance** A small risk of pathogen transmission exists, but if in doubt, any material removed from the pit can be composted further in a regular compost heap, or mixed with additional soil and put into a ‘tree pit’, i.e. a nutrient-filled pit used for planting a tree.

As opposed to sludge, which originates from a variety of domestic, chemical and industrial sources, compost has very few chemical inputs. The only chemical sources that could contaminate compost might originate from contaminated organic material (e.g. pesticides) or from chemicals that are excreted by humans (e.g. medication). Compared to the cleaning, pharmaceutical and processing chemicals that may find their way into sludge, compost can be considered as a less contaminated product.

Acceptability may be low at first, but demonstration units and hands-on experience are effective ways of demonstrating the non-offensive nature of the material.

**Maintenance** The material must be allowed to mature adequately before it is removed from the system and then it can be used without further treatment.

**Pros & Cons:**

- + Potential income generation (improved yield and productivity of plants)
- + Low risk of pathogen transmission
- + Can improve the structure and water-holding capacity of soil
- + Simple technique for all users
- + Low cost
- Requires a year or more of maturation
- Does not replace fertilizer (N, P, K)

**References**

---

- \_ Del Porto, D. and Steinfeld, C. (1999). *The Composting Toilet System Book. A Practical Guide to Choosing, Planning and Maintaining Composting Toilet Systems, an Alternative to Sewer and Septic Systems*. The Center for Ecological Pollution Prevention (CEPP), Massachusetts, USA.
- \_ Jenkins, J. (1999). *The Humanure Handbook: a Guide to Composting Human Manure. (2nd ed.)*. Jenkins Publishing, Grove City, Pa, USA.  
Available: [www.jenkinspublishing.com](http://www.jenkinspublishing.com)
- \_ Morgan, P. (2004). *An Ecological Approach to Sanitation in Africa: A Compilation of Experiences*. Aquamor, Harare, Zimbabwe.  
Available: [www.ecosanres.org](http://www.ecosanres.org)
- \_ Morgan, P. (2007). *Toilets that make compost*. Stockholm Environment Institute, Stockholm, Sweden. pp 81–90.  
Available: [www.ecosanres.org](http://www.ecosanres.org)
- \_ NWP (2006). *Smart Sanitation Solutions. Examples of innovative, low-cost technologies for toilets, collection, transportation, treatment and use of sanitation products*. Netherlands Water Partnership, The Netherlands. pp 49.

Application Level	Management Level	Inputs:
<ul style="list-style-type: none"> <li>★★ Household</li> <li>★★ Neighbourhood</li> <li>★★ City</li> </ul>	<ul style="list-style-type: none"> <li>★★ Household</li> <li>★★ Shared</li> <li>★★ Public</li> </ul>	<ul style="list-style-type: none"> <li><span style="display: inline-block; width: 15px; height: 10px; background-color: #808080; border: 1px solid #000; margin-right: 5px;"></span> Effluent</li> <li><span style="display: inline-block; width: 15px; height: 10px; background-color: #ADD8E6; border: 1px solid #000; margin-right: 5px;"></span> Stormwater</li> </ul>

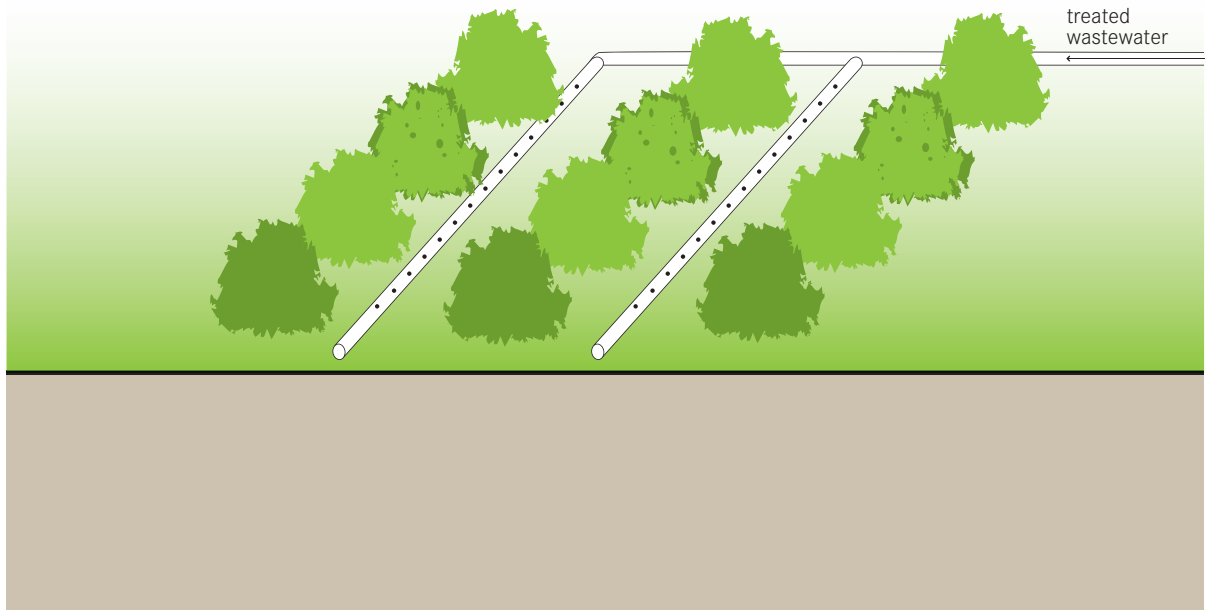

**To reduce dependence on freshwater and maintain a constant source of irrigation water throughout the year, waste waters of varying qualities can be used in agriculture. Generally, only waters that have had secondary treatment (i.e. physical and biological treatment) should be used to limit the risk of crop contamination and the health risk to workers.**

There are two kinds of irrigation technologies that are appropriate for using treated wastewaters:

- 1) Drip irrigation where the water is dripped slowly on or near the root area; and
- 2) Surface water irrigation where water is routed overland in a series of dug channels or furrows.

To minimize evaporation and contact with pathogens, spray irrigation should be avoided.

Properly treated wastewater can significantly reduce dependence on freshwater, and/or improve crop yields by supplying increased water and nutrients to plants. Raw sewage or untreated blackwater should not be used, and even well-treated water should be used with caution. Long-term use of poorly or improperly treated water may cause long-term damage to the soil structure and its ability to hold water.

**Adequacy** Generally, drip irrigation is the most appropriate irrigation method; it is especially good for arid and drought prone areas. Surface irrigation is prone to large losses from evaporation but requires little/no infrastructure and may be appropriate in some situations.

Crops such as corn, alfalfa (and other feed), fibres (cotton), trees, tobacco, fruit trees (mangos) and foods requiring processing (sugar beet) can be grown safely with treated effluent. More care should be taken when growing fruits and vegetables that may be eaten raw (e.g. tomatoes) that could come in contact with the water. Energy crops like eucalyptus, poplar, willow, or ash trees can be grown in short-rotation and harvested for biofuel production. Since the trees are not for consumption, this is a safe, efficient way of using lower-quality effluent.

There are potential health risks if water is not properly pre-treated (i.e. inadequate pathogen reduction). Soil quality can be degraded over time (e.g. accumulation of salts) if poorly treated wastewater is applied. The application rate must be appropriate for the soil, crop and climate, or it could be damaging.

**Health Aspects/Acceptance** Appropriate pre-treatment should precede any irrigation scheme to limit health risks to those who come in contact with the water. As well, depending on the degree of treatment that the effluent has undergone, it may be contaminated with the different chemicals that are discharged into the system. When effluent is used for irrigation, households and industries connected to the system should be made aware of the products that are and are not appropriate for discharging into the system.

Drip irrigation is the only type of irrigation that should be used with edible crops, and even then, care should be taken to prevent workers and harvested crops from coming in contact with the treated effluent.

Despite safety concerns, irrigation with effluent is an effective way to recycle nutrients and water.

**Maintenance** Drip irrigation systems must be cleaned periodically to remove any built-up solids. The pipes should be checked for leaks as they are prone to damage from rodents and humans.

Drip irrigation is more costly than conventional irrigation, but has improved yields and decreased water/operating costs.

#### **Pros & Cons:**

- + Reduces depletion of ground water and improves availability of drinking water
- + Reduced need for fertilizer
- + Low to moderate capital cost; low to moderate operating cost
- + Potential for local job creation and income generation
- + Low risk of pathogen transmission if water is properly pre-treated
- + Potential to improved health, self-reliance in community
- Must be well settled - very sensitive to clogging
- May require expert design and installation
- Not all parts and materials may be available locally

#### **References**

- \_ Ayers, R.S. and Westcot, D.W. (1994). *FAO Irrigation and Drainage Paper 29 Rev. 1. Water Quality for Agriculture*. FAO, Rome.  
Available: [www.fao.org](http://www.fao.org)
- \_ Crites, R. and Tchobanoglous, G. (1998). *Small and Decentralized Wastewater Management Systems*. WCB and McGraw-Hill, New York, USA. pp 878-886.
- \_ Mara, D.D. (1996). *Low-Cost Urban Sanitation*. Wiley, Chichester, UK. pp 150-152.
- \_ Mara, D.D. (2004). *Domestic Wastewater Treatment in Developing Countries*. Earthscan, London. pp 231-245.
- \_ Okun, D.A. and Ponghis, G. (1975). *Community Wastewater Collection and Disposal*. WHO, Geneva. pp 211-220.
- \_ Sasse, L. (1998). *DEWATS: Decentralised Wastewater Treatment in Developing Countries*. BORDA, Bremen Overseas Research and Development Association, Bremen, Germany.
- \_ WHO (2006). *Guidelines for the safe use of wastewater, excreta and greywater- Volume 2: Wastewater and excreta use in agriculture*. WHO, Geneva.

**Application Level**

- ★★ Household
- ★ Neighbourhood
- City

**Management Level**

- ★★ Household
- ★★ Shared
- Public

**Inputs:**

- Effluent
- Greywater
- Urine
- Anal Cleansing Water

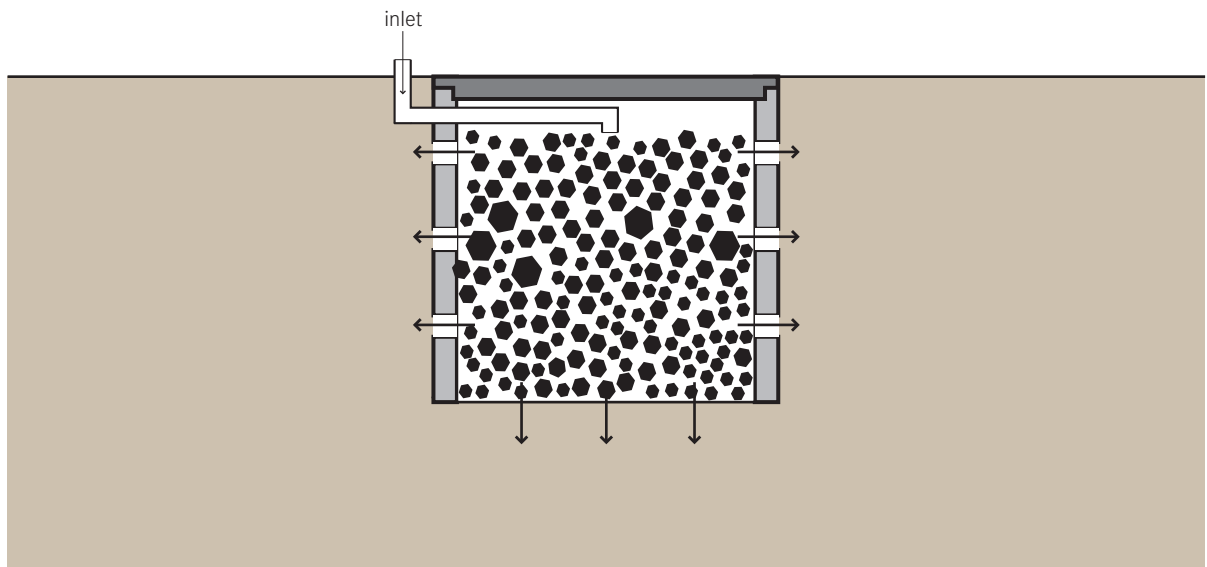

**A Soak Pit, also known as a soakaway or leach pit, is a covered, porous-walled chamber that allows water to slowly soak into the ground. Pre-settled effluent from a Collection and Storage/Treatment or (Semi-) Centralized Treatment technology is discharged to the underground chamber from where it infiltrates into the surrounding soil.**

The Soak Pit can be left empty and lined with a porous material (to provide support and prevent collapse), or left unlined and filled with coarse rocks and gravel. The rocks and gravel will prevent the walls from collapsing, but will still provide adequate space for the wastewater. In both cases, a layer of sand and fine gravel should be spread across the bottom to help disperse the flow. The soak pit should be between 1.5 and 4 m deep, but never less than 1.5 m above the ground water table.

As wastewater (pre-treated greywater or blackwater) percolates through the soil from the Soak Pit, small particles are filtered out by the soil matrix and organics are digested by micro-organisms. Thus, Soak Pits are best suited to soils with good absorptive properties; clay, hard packed or rocky soils are not appropriate.

**Adequacy** A Soak Pit does not provide adequate treatment for raw wastewater and the pit will clog quickly. A Soak Pit should be used for discharging pre-settled blackwater or greywater.

Soak pits are appropriate for rural and peri-urban settlements. They depend on soil with a sufficient absorptive capacity. They are not appropriate for areas that are prone to flooding or have high groundwater tables.

**Health Aspects/Acceptance** As long as the Soak Pit is not used for raw sewage, and as long as the previous Collection and Storage/Treatment technology is functioning well, health concerns are minimal. The technology is located underground and thus, humans and animals should have no contact with the effluent. It is important however, that the Soak Pit is located a safe distance from a drinking water source (ideally 30 m).

Since the Soak Pit is odourless and not visible, it should be accepted by even the most sensitive communities.

**Maintenance** A well-sized Soak Pit should last between 3 and 5 years without maintenance. To extend the life of a Soak Pit, care should be taken to ensure that the effluent has been clarified and/or filtered well to



prevent excessive build up of solids. The Soak Pit should be kept away from high-traffic areas so that the soil above and around it is not compacted. When the performance of the Soak Pit deteriorates, the material inside the soak pit can be excavated and refilled. To allow for future access, a removable (preferably concrete) lid should be used to seal the pit until it needs to be maintained.

Particles and biomass will eventually clog the pit and it will need to be cleaned or moved.

#### **Pros & Cons:**

- + Can be built and repaired with locally available materials
- + Small land area required
- + Low capital cost; low operating cost
- + Can be built and maintained with locally available materials
- + Simple technique for all users
- Pretreatment is required to prevent clogging, although eventual clogging is inevitable
- May negatively affect soil and groundwater properties

#### **References**

---

- \_ Ahrens, B. (2005). *A Comparison of Wash Area and Soak Pit Construction: The Changing Nature of Urban, Rural, and Peri-Urban Linkages in Sikasso, Mali*. Peace Corp, USA. Available: [www.cee.mtu.edu/peacecorps/reports/Brooke\\_Ahrens\\_Final\\_Report.pdf](http://www.cee.mtu.edu/peacecorps/reports/Brooke_Ahrens_Final_Report.pdf) (Detailed construction instructions)
- \_ Mara, DD. (1996). *Low-Cost Urban Sanitation*. Wiley, Chichester, UK. pp 63–65. (Dimensioning calculations)
- \_ Polprasert, C. and Rajput, VS. (1982). *Environmental Sanitation Reviews: Septic Tank and Septic Systems*. Environmental Sanitation Information Center, AIT, Bangkok, Thailand. pp 31–58.

Application Level	Management Level	Inputs:
<input checked="" type="checkbox"/> Household <input checked="" type="checkbox"/> Neighbourhood <input type="checkbox"/> City	<input checked="" type="checkbox"/> Household <input checked="" type="checkbox"/> Shared <input checked="" type="checkbox"/> Public	<input checked="" type="checkbox"/> Effluent

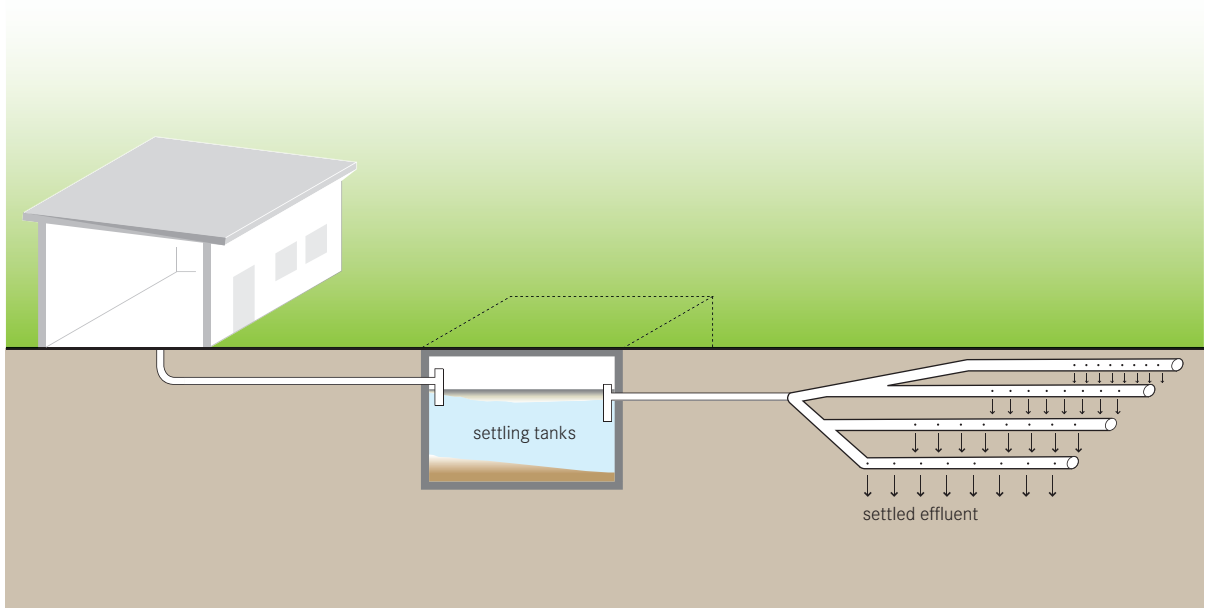

**A Leach Field, or drainage field, is a network perforated pipes that are laid in underground gravel-filled trenches to dissipate the effluent from a water-based Collection and Storage/Treatment or (Semi-) Centralized Treatment technology.**

Effluent is fed into a distribution box which directs the flow into several parallel channels. A small dosing system releases the pressurized effluent into the Leach Field on a timer (usually 3 to 4 times a day). This ensures that the whole length of the Leach Field is utilized and that aerobic conditions are allowed to recover between dosings. Each trench is 0.3 to 1.5m deep and 0.3 to 1 m wide. The bottom of each trench is filled with about 15 cm of clean rock and a perforated distribution pipe is laid overtop. More rock covers the pipe so that it is completely surrounded. The layer of rock is covered with a layer of geotextile fabric to prevent small particles from plugging the pipe. A final layer of sand and/or topsoil covers the fabric and fills the trench to the ground level. The pipe should be placed 15 cm from the surface to prevent effluent from surfacing. The trenches should be dug no longer than 20m in length at least 1 to 2 m apart.

**Adequacy** Leach Fields require a large area and soil with good absorptive capacity to effectively dissipate the effluent.

To prevent contamination, a Leach Field should be located 30m away from a drinking water supply. Leach fields are not appropriate for dense urban areas. They can be used in almost every temperature, although there may be problems with pooling effluent in areas where the ground freezes.

Homeowners who have a Leach Field must be aware of how it works and what their maintenance responsibilities are. Trees and deep-rooted plants should be kept away from the Leach Field as they can crack and disturb the tile bed.

**Health Aspects/Acceptance** Since the technology is underground and it requires little attention, users will rarely come in contact with the effluent and so it should pose no health risk. The Leach Field must be kept as far away as possible from (>30m) any potential potable water sources to avoid contamination.

**Upgrading** A Leach Field should be laid out such that it would not interfere with a future sewer connection.

The collection technology which precedes the Leach Field (e.g. Septic Tank: S9) should be equipped with a sewer connection so that if, or when, the Leach Field needs to be replaced, the changeover can be done with minimal disruption.

**Maintenance** A Leach Field will become clogged over time, although with a well-functioning pre-treatment technology, this should take many years. Effectively, a Leach Field should require minimal maintenance, however if the system stops working efficiently, the pipes should be cleaned and/or removed and replaced. To maintain the Leach Field, there should be no plants or trees above it and no heavy traffic, which may crush the pipes or compact the soil.

**Pros & Cons:**

- + Can be used for the combined treatment of blackwater and greywater
- + Has a lifespan of 20 or more years (depending on conditions)
- + Low to moderate capital cost, low operating cost
- Requires expert design and construction
- Requires a large area (on a per person basis)
- Not all parts and materials may be available locally
- Pretreatment is required to prevent clogging
- May negatively affect soil and groundwater properties

**References**

---

- \_ Crites, R. and Tchobanoglous, G. (1998). *Small and Decentralized Wastewater Management Systems*. WCB and McGraw-Hill, New York, USA. pp 905-927.
- \_ Polprasert, C. and Rajput, VS. (1982). *Environmental Sanitation Reviews: Septic Tank and Septic Systems*. Environmental Sanitation Information Center, AIT, Bangkok, Thailand.
- \_ USEPA (1980). *Design manual- on-site wastewater treatment and disposal systems. EPA-625/1-80-012*. Office of Research and Development, Municipal Environmental Research Laboratory, Cincinnati, Ohio. Available: [www.epa.gov](http://www.epa.gov)

Application Level	Management Level	Inputs:
<input type="checkbox"/> Household	<input type="checkbox"/> Household	<input checked="" type="checkbox"/> Effluent
<input checked="" type="checkbox"/> Neighbourhood	<input checked="" type="checkbox"/> Shared	
<input checked="" type="checkbox"/> City	<input checked="" type="checkbox"/> Public	

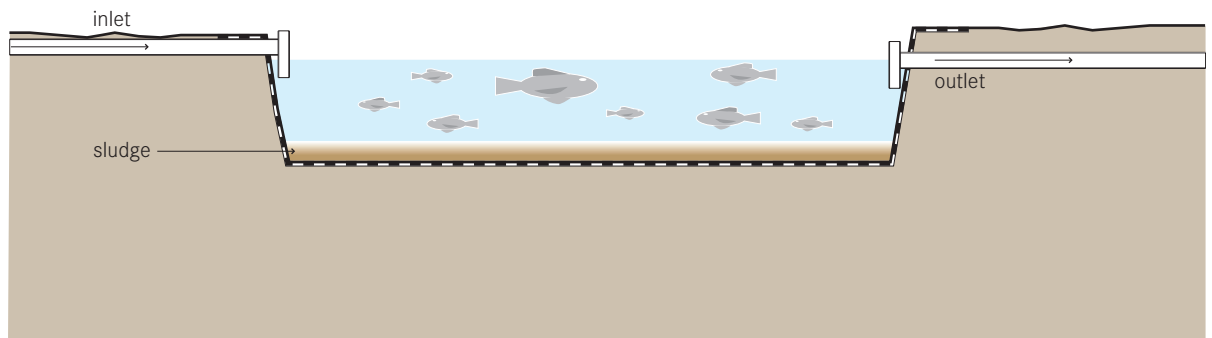

**Aquaculture refers to the controlled cultivation of aquatic plants and animals; this technology sheet refers exclusively to the raising of fish while the following page on Floating Macrophytes (D9) addresses the cultivation of plants. Fish can be grown in ponds where they feed on algae and other organisms that grow in the nutrient-rich water. Through feeding, the nutrients from the wastewater are removed and the fish are eventually harvested for consumption.**

Three kinds of aquaculture designs for raising fish exist:

- 1) fertilization of fish ponds with excreta/sludge;
- 2) fertilization of fish ponds with effluent; and
- 3) fish grown directly in aerobic ponds.

When introducing nutrients in the form of effluent or sludge it is important to limit the additions such that aerobic conditions are maintained. BOD should not exceed 1 g/m<sup>2</sup>d and oxygen should be at least 4 mg/L. Fish introduced to aerobic ponds can effectively reduce algae and help control mosquito populations.

The fish themselves do not dramatically improve the water quality, but because of their economic value they can offset the costs of operating a treatment facility. Under ideal operating conditions, up to 10,000 kg/ha of

fish can be harvested. If the fish are not acceptable for human consumption, they can be a valuable source of protein for other high-value carnivores (like shrimp) or converted into fishmeal for pigs and chickens.

**Adequacy** A fish pond is only appropriate when there is a sufficient amount of land (or preexisting pond), a source of fresh water and a suitable climate. The water that is used to dilute the waste should not be too warm, and the ammonia levels should be kept low or negligible.

Only fish that are tolerant of low dissolved oxygen levels should be chosen. They should not be carnivores and they should be tolerant to diseases and adverse environmental conditions. Different varieties of carp, milkfish and tilapia have been successful, but the specific choice will depend on local preference and suitability.

This technology is only appropriate for warm or tropical climates with no freezing temperatures, and preferably with high rainfall and minimal evaporation.

**Health Aspects/Acceptance** Where there is no other source of readily available protein, this technology may be embraced. The quality and condition of the fish will also influence local acceptance. There may be

concern with contamination of the fish, especially during the harvesting, cleaning and preparation of the fish. If it is cooked well it should be safe, but it is advisable to move the fish to a clear-water pond for several weeks before they are harvested for consumption.

**Maintenance** The fish need to be harvested when they reach an appropriate age/size. Sometimes after harvesting, the pond should be drained so that (a) it can be desludged and (b) it can be left to dry in the sun for 1 to 2 weeks to destroy any pathogens living on the bottom or sides of the pond.

#### Pros & Cons:

- + Can provide a cheap, locally available protein source
- + Low to moderate capital cost; operating costs should be offset by production revenue
- + Potential for local job creation and income generation
- + Can be built and maintained with locally available materials
- Fish may pose a health risk if improperly prepared or cooked
- Requires abundance of fresh water
- Requires large land (pond) area
- May require expert design and installation

#### References

- \_ Cointreau, S., et al. (1987). *Aquaculture with treated wastewater: a status report on studies conducted in Lima, Perú. Technical Note 3*. UNDP/World Bank, Washington D.C. USA. 1987.
- \_ Cross, P. and Strauss, M. (1985). *Health Aspects of Nightsoil and Sludge Use in Agriculture and Aquaculture*. International Reference Centre for Waste Disposal, Dübendorf, Switzerland.
- \_ Edwards, P. and Pullin, RSV. (eds) (1990). *Wastewater-Fed Aquaculture*. Proceedings: International Seminar on Wastewater Reclamation and Reuse for Aquaculture, Calcutta, India. (Compilation of topical papers)
- \_ Iqbal, S. (1999). *Duckweed Aquaculture-Potentials, Possibilities and Limitations for Combined Wastewater Treatment and Animal Feed Production in Developing Countries*. Sandec, Dübendorf, Switzerland.
- \_ Joint FAO/NACA/WHO Study Group (1999). *Food safety issues associated with products from aquaculture*. World Health Organization Technical Report Series No. 883. Available: [www.who.int](http://www.who.int)
- \_ Mara, DD. (2004). *Domestic Wastewater Treatment in Developing Countries*. Earthscan, London. pp 253-261.
- \_ Polprasert, C., et al. (2001). *Wastewater Treatment II, Natural Systems for Wastewater Management*. Lecture Notes. IHE, Delft. Available: [www.who.int](http://www.who.int) (Chapter 8 - Aquaculture and Reuse Aspects).
- \_ Rose, GD. (1999). *Community-Based Technologies for Domestic Wastewater Treatment and Reuse: options for urban agriculture*. IDRC Ottawa. Available: <http://idrinfor.idrc.ca>
- \_ Skillicorn, W., Journey, K. and Spira, P. (1993). *Duckweed aquaculture: A new aquatic farming system for developing countries*. World Bank, Washington, DC. Available: <http://www.p2pays.org/ref/09/08875.htm> (Comprehensive manual)

## D.9 Floating Plant (Macrophyte) Pond

Applicable to:  
System 1, 5, 6, 7, 8

D.9

Application Level	Management Level	Inputs:
<input type="checkbox"/> Household	<input type="checkbox"/> Household	<input checked="" type="checkbox"/> Effluent
<input checked="" type="checkbox"/> Neighbourhood	<input checked="" type="checkbox"/> Shared	
<input checked="" type="checkbox"/> City	<input checked="" type="checkbox"/> Public	

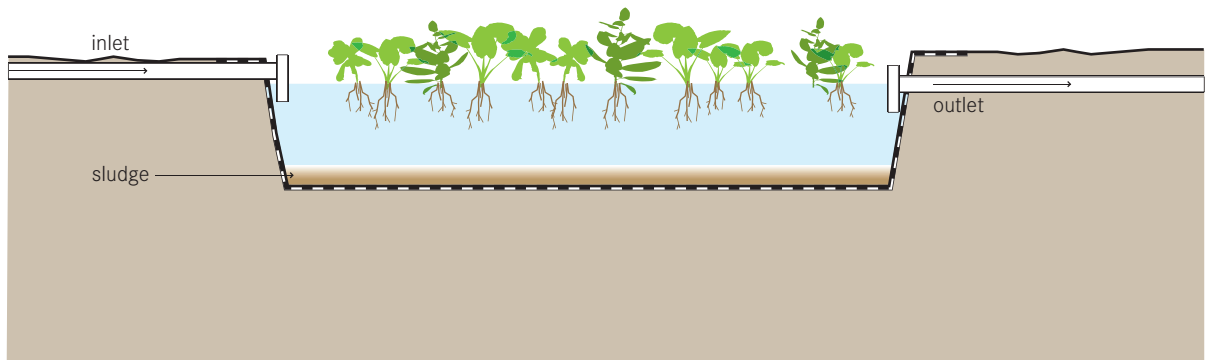

**A floating plant pond is a modified maturation pond with floating (macrophyte) plants. Plants such as water hyacinths or duckweed float on the surface while the roots hang down into the water to uptake nutrients and filter the water that flows by.**

Water hyacinths are perennial, freshwater, aquatic macrophytes that grow especially fast in wastewater. The plants can grow large: between 0.5 to 1.2m from top to bottom. The long roots provide a fixed medium for bacteria which in turn degrade the organics in the water passing by.

Duckweed is a fast growing, high protein plant that can be used fresh or dried as a food for fish or poultry. It is also tolerant of a variety of conditions and can remove significant quantities of nutrients from wastewater.

To provide extra oxygen to a floating plant technology, the water can be mechanically aerated but at the cost of increased power and machinery. Aerated ponds can withstand higher loads and can be built with smaller footprints. Non-aerated ponds should not be too deep otherwise there will be insufficient contact between the bacteria-harboring roots and the wastewater.

**Adequacy** The technology can achieve high removal rates of both BOD and suspended solids, although pathogen removal is not substantial.

Harvested hyacinths can be used as a source of fibre for rope, textiles, baskets, etc. Depending on the income generated, the technology can be cost neutral. Duckweed can be used as the sole food source to some herbivorous fish.

This technology is only appropriate for warm or tropical climates with no freezing temperatures, and preferably with high rainfall and minimal evaporation. Different, locally appropriate plants can be selected depending on availability and the wastewater type.

Trained staff is required for the constant operation and maintenance of the pond.

**Health Aspects/Acceptance** Water hyacinth has attractive, lavender flowers. A well designed and maintained system can add value and interest to otherwise barren land.

Adequate signage and fencing should be used to prevent people and animals from coming in contact with the water.

**Maintenance** Floating plants require constant harvesting. The harvested biomass can be used for small artisanal businesses, or it can be composted. Mosquito problems can develop when the plants are not harvested regularly. Depending on the amount of solids entering, the pond must be desludged periodically.

**Pros & Cons:**

- + Water hyacinth grows rapidly and is attractive
- + High reduction of BOD and solids; low reduction of pathogens
- + Low to moderate capital cost; operating cost can be offset by revenue
- + Potential for local job creation and income generation
- + Can be built and maintained with locally available materials
- Can become an invasive species if released into natural environments
- Requires large land (pond) area

**References**

- \_ Abbasi, S.A. (1987). *Aquatic plant based water treatment systems in Asia*. pp 175–198, In: Aquatic Plants for Water Treatment and Resource Recovery, K.R. Reddy and W.H. Smith (eds.), Magnolia Publishing Inc., Orlando, Florida.
- \_ Bagnall, L.O., Schertz, C.E. and Dubbe, D.R. (1987). *Harvesting and handling of biomass*. pp. 599–619, In: Aquatic Plants for Water Treatment and Resource Recovery, K.R. Reddy and W.H. Smith (eds.), Magnolia Publishing Inc., Orlando, Florida.
- \_ Crites, R. and Tchobanoglous, G. (1998). *Small and Decentralized Wastewater Management Systems*. WCB and McGraw-Hill, New York, USA, pp 609–627. (Comprehensive summary chapter including solved problems)
- \_ Gerba, C.P., et al. (1995). *Water-Quality Study of Graywater Treatment Systems*. Water Resources Bulletin 31(1): 109–116.
- \_ Iqbal, S. (1999). *Duckweed Aquaculture-Potentials, Possibilities and Limitations for Combined Wastewater Treatment and Animal Feed Production in Developing Countries*. Sandec, Dübendorf, Switzerland.
- \_ McDonald, R.D. and Wolverton, B.C. (1980). Comparative study of wastewater lagoon with and without water hyacinth. *Economic Botany*: 34 (2): 101–110.
- \_ Polprasert, C., et al. (2001). *Wastewater Treatment II, Natural Systems for Wastewater Management*. IHE, Delft. (Comprehensive Design Manual: see Chapter 4 – Water Hyacinth Ponds.)
- \_ Rose, G.D. (1999). *Community-Based Technologies for Domestic Wastewater Treatment and Reuse: options for urban agriculture*. IDRC, Ottawa. Available: <http://idinfo.idrc.ca>
- \_ Skillicorn, W., Journey, K. and Spira, P. (1993). *Duckweed aquaculture: A new aquatic farming system for developing countries*. World Bank, Washington, DC. Available: [www.p2pays.org/ref/09/08875.htm](http://www.p2pays.org/ref/09/08875.htm) (Comprehensive manual)
- \_ US Environmental Protection Agency (1988). *Design Manual: Constructed Wetlands and Aquatic Plant Systems for Municipal Wastewater Treatment*. USEPA, Cincinnati, Ohio. Available: [www.epa.gov/owow/wetlands/pdf/design.pdf](http://www.epa.gov/owow/wetlands/pdf/design.pdf)

Application Level	Management Level	Inputs:
<ul style="list-style-type: none"> <li>★★ Household</li> <li>★★ Neighbourhood</li> <li>★★ City</li> </ul>	<ul style="list-style-type: none"> <li>★★ Household</li> <li>★★ Shared</li> <li>★★ Public</li> </ul>	<ul style="list-style-type: none"> <li><span style="display: inline-block; width: 15px; height: 10px; background-color: #808080; border: 1px solid #000; margin-right: 5px;"></span> Effluent</li> <li><span style="display: inline-block; width: 15px; height: 10px; background-color: #ADD8E6; border: 1px solid #000; margin-right: 5px;"></span> Stormwater</li> </ul>

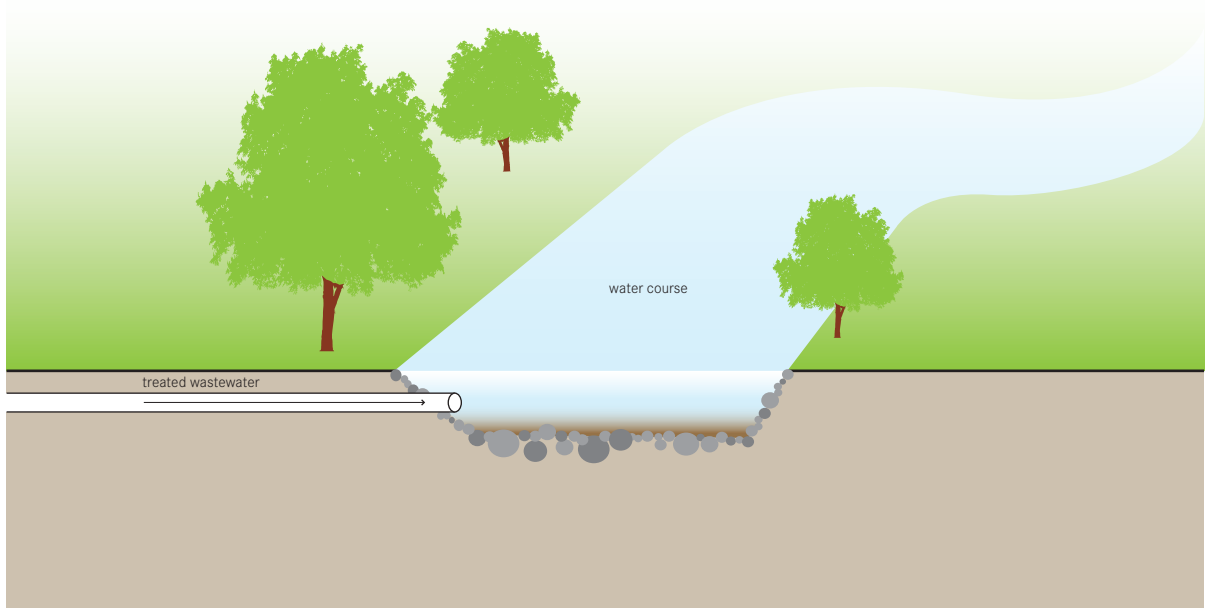

**Treated effluent and/or stormwater can be discharged directly into receiving water bodies (such as rivers, lakes, etc.) or into the ground to recharge aquifers.**

It is necessary to ensure that the assimilation capacity of the receiving water body is not exceeded, i.e. that the receiving body can accept the quantity of nutrients without being overloaded. Parameters such as turbidity, temperature, suspended solids, BOD, nitrogen and phosphorus (among others) should be carefully controlled and monitored before releasing any water into a natural body. The use of the water body, whether it is used for industry, recreation, spawning habitat, etc., will influence the quality and quantity of treated wastewater that can be introduced without deleterious effects.

Local authorities should be consulted to determine the discharge limits for the relevant parameters as they can vary widely. For especially sensitive areas, chlorination may be required to meet microbiological limits.

Alternatively, water can be discharged into aquifers. Groundwater recharge is increasing in popularity as groundwater resources deplete and as saltwater intru-

sion becomes a greater threat to coastal communities. Although the soil is known to act as a filter for a variety of contaminants, groundwater recharge should not be viewed as a treatment method. Once an aquifer is contaminated, it is next to impossible to reclaim it. The quality of water extracted from a recharge aquifer is a function of the quality of the wastewater introduced, the method of recharge, the characteristics of the aquifer, the residence time, the amount of blending with other waters and the history of the system. Careful analysis of these factors should precede any recharge project.

**Adequacy** The adequacy of discharge into a water body or aquifer will depend entirely on the local environmental conditions and legal regulations. Generally, discharge to a water body is only appropriate when there is a safe distance between the discharge point and the next closest point of use. Similarly, groundwater recharge is most appropriate for areas that are at risk from salt water intrusion or aquifers that have a long retention time.

Depending on the volume, the point of discharge and/or the quality of the water, a permit may be required.



**Health Aspects/Acceptance** Generally, cations ( $Mg^{2+}$ ,  $K^+$ ,  $NH_4^+$ ) and organic matter will be retained within a solid matrix, while other contaminants (such as nitrates) will remain in the water. There are numerous models for the remediation potential of contaminants and microorganisms, but predicting downstream, or extracted water quality for a large suite of parameters is rarely feasible. Therefore, potable and non-potable water sources should be clearly identified, the most important parameters modelled and a risk assessment completed.

**Maintenance** Regular monitoring and sampling is important to ensure compliance with regulations and to ensure public health requirements. Depending on the recharge method, some mechanical maintenance may be required.

**Pros & Cons:**

- + May provide a 'drought-proof' water supply (from groundwater)
- + May increase productivity of water-bodies by maintaining constant levels
- Discharge of nutrients and micropollutants may affect natural water bodies and/or drinking water
- Introduction of pollutants may have long-term impacts
- May negatively affect soil and groundwater properties

**References**

- \_ ARGOSS (2001). *Guidelines for assessing the risk to groundwater from on-site sanitation*. British Geological Survey Commissioned Report, CR/01/142. Available: [www.worldbank.org](http://www.worldbank.org)
- \_ Seiler, K.P. and Gat, J.R. (2007). *Groundwater Recharge from Run-off, Infiltration and Percolation*. Springer, The Netherlands.
- \_ Tchobanoglous, G., Burton, F.L. and Stensel, H.D. (2003). *Wastewater Engineering: Treatment and Reuse, 4th Edition*. Metcalf & Eddy, New York.
- \_ WHO (2006). *Guidelines for the safe use of wastewater, excreta and greywater- Volume 3: Wastewater and excreta use in aquaculture*. WHO, Geneva.

Application Level	Management Level	Inputs:
<input type="checkbox"/> Household	<input checked="" type="checkbox"/> Household	<input checked="" type="checkbox"/> Treated Sludge
<input checked="" type="checkbox"/> Neighbourhood	<input checked="" type="checkbox"/> Shared	
<input checked="" type="checkbox"/> City	<input checked="" type="checkbox"/> Public	

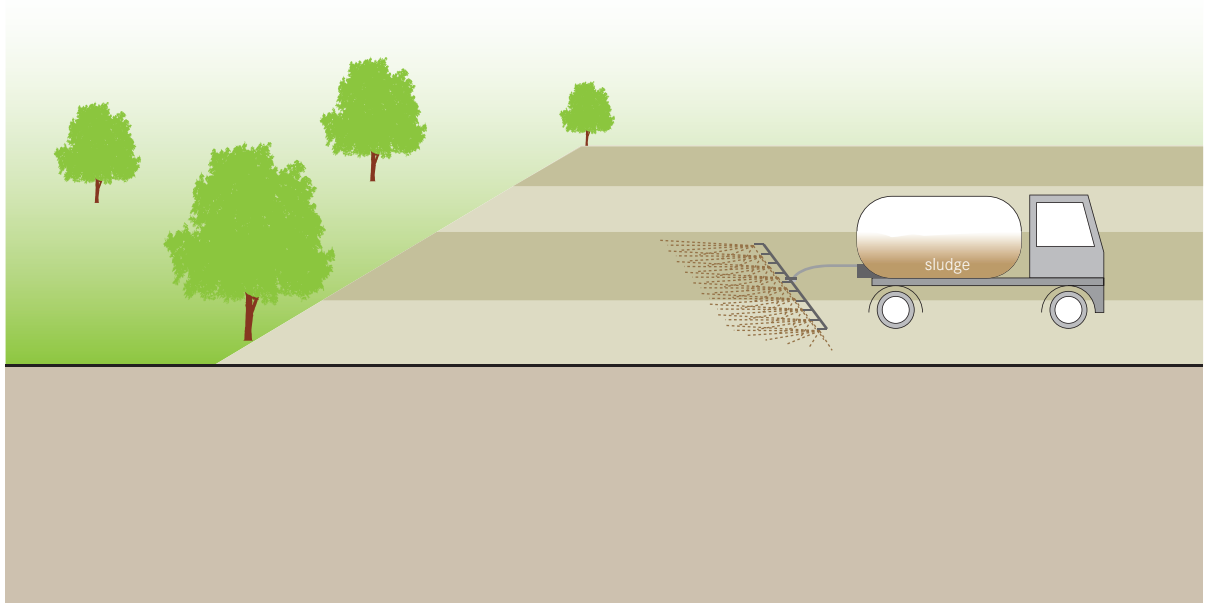

**Digested or stabilized Faecal Sludge is referred to as 'Biosolids'. Depending on the quality of the biosolids, they can be applied to public or private lands, for landscaping or for agriculture.**

The USEPA defines different levels of biosolids depending on the treatment and quality, and therefore the health risk. Class A biosolids (i.e. biosolids that can be sold for public use) can be used with nearly no restrictions. Please consult the guidelines for specific use criteria. Biosolids can be used in agriculture, home gardening, forestry, sod and turf growing, landscaping, parks, golf courses, mine reclamation, dump cover, or erosion control. Although biosolids have lower nutrient levels than commercial fertilizers (for nitrogen, phosphorus and potassium respectively), they can be used to replace part or all of commercial fertilizers that are used. Additionally, biosolids have been found to have properties that are superior to those of fertilizers, such as bulking properties, water retention properties and the slow, steady release of nutrients. Biosolids are spread on the ground surface using conventional manure spreaders, tank trucks or specially designed vehicles. More liquid biosolids (e.g. from anaer-

obic reactors) can be sprayed onto, or injected into, the ground. Dewatered biosolids may be 'flung', which is most common in forests.

**Adequacy** Although biosolids are sometimes criticized for containing potentially high levels of metals or contaminants, commercial fertilizers are also contaminated to varying degrees, most likely with cadmium or other heavy metals. Faecal sludge from pit latrines has no, if any, chemical inputs and is therefore not a high risk source of contamination. Faecal sludge that originates at large-scale wastewater treatment plants is more likely to be contaminated since it receives industrial and domestic chemicals, as well as surface water run-off which may contain hydrocarbons and metals. Depending on the sludge source, biosolids can serve as a valuable and often much-needed source of nutrients. Land application of biosolids may be less expensive than disposal. Application rates and usages for biosolids should take into account not only the presence of pathogens and contaminants, but also the quantity of nutrients such that they are spread at a sustainable and 'agronomic' rate.

Appropriate safety and application regulations should be followed.

**Health Aspects/Acceptance** The greatest barrier to biosolid use is generally acceptance. However, even when biosolids are not accepted in agriculture or by local industries, they can still be useful for municipal projects and can actually provide significant savings to public projects (e.g. mine reclamation).

Depending on the source of the faecal sludge and on the treatment method, biosolids can be treated to a level where they are generally safe and without significant odour or vector problems.

**Maintenance** Spreading equipment must be maintained to ensure continued use. The amount and rate of biosolid application should be monitored to prevent overloading and thus, the potential for nutrient pollution.

**Pros & Cons:**

- + Can accelerate reforestation
- + Can reduce use of chemical fertilizers and improve water retention of soils
- + Can reduce erosion
- + Low cost
- May pose public health risk, depending on the quality and application
- Odours are normally noticeable (depending on prior treatment)
- May require special spreading equipment
- Micropollutants may accumulate in the soil and contaminate groundwater

**References**

---

- \_ U.S. EPA (1999). *Biosolids Generation, Use, and Disposal in the United States*, EPA-530/R-99-009. U.S. Environmental Protection Agency: Washington, D.C.  
Available: [www.epa.gov](http://www.epa.gov)
- \_ U.S. EPA (1994). *A Plain English Guide to the EPA Part 503 Biosolids Rule*, EPA832-R-93-003. U.S. Environmental Protection Agency: Washington, D.C.  
Available: [www.epa.gov](http://www.epa.gov)

Application Level	Management Level	Inputs:
<input type="checkbox"/> ★ Household <input type="checkbox"/> ★ Neighbourhood <input type="checkbox"/> ★★ City	<input type="checkbox"/> ★ Household <input type="checkbox"/> ★★ Shared <input type="checkbox"/> ★★ Public	<input type="checkbox"/> Faecal Sludge <input type="checkbox"/> Faeces <input type="checkbox"/> Treated Sludge <input type="checkbox"/> Dry Cleansing Material

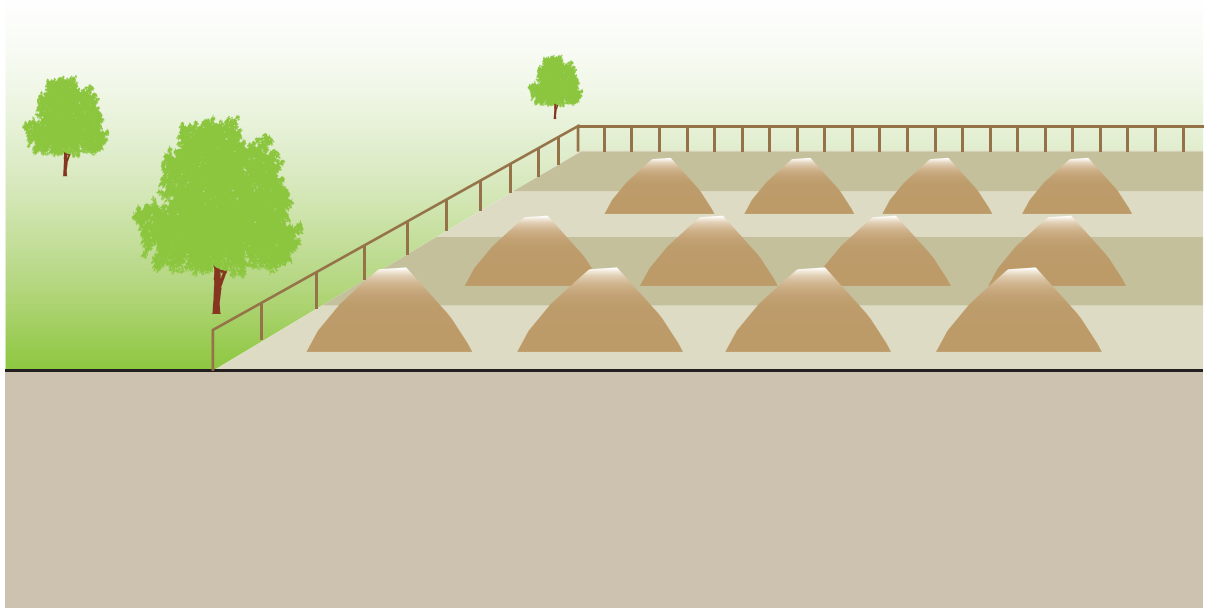

**Surface Disposal refers to the stockpiling of sludge, faeces, biosolids, or other materials that cannot be used elsewhere. Once the material has been taken to a Surface Disposal site, it is not used later. This technology is primarily used for biosolids, although it is applicable for any type of dry, unusable material.**

One application of Surface Disposal that is shown on the System Templates is the disposal of dry cleansing materials, such as toilet paper, corn cobs, stones, newspaper and/or leaves. These materials can not always be included along with other water-based products in some technologies and must be separated. A rubbish bin should be provided beside the User Interface to collect the cleansing materials. Dry materials can be burned (e.g. corn cobs) or disposed of along with the household waste. For simplicity, the remainder of this Technology Information Sheet will be dedicated to faecal sludge, since standard solid-waste practices are beyond the scope of this Compendium.

When there is no demand or acceptance for the beneficial use of biosolids, they can be placed in monofills (biosolids-only landfills) or heaped into permanent

piles. The main difference between Surface Disposal and Land Application is the application rate. There is no limit to the quantity of biosolids that can be applied to the surface since there are no concerns about nutrient loads or agronomic rates. There is however, concern related to groundwater contamination and leaching. More advanced surface disposal systems may incorporate a liner and leachate collection system in order to prevent nutrients and contaminants from infiltrating the groundwater.

Landfilling biosolids along with Municipal Solid Waste (MSW) is not advisable since it reduces the life of a landfill which has been designed for the containment of more noxious materials. As opposed to more centralized MSW landfills, Surface Disposal sites can be situated close to where the faecal sludge is treated, limiting the need for long transport distances.

**Adequacy** Since there are no benefits gained from this type of disposal technology, it should not be considered as a primary option. However, where acceptance towards biosolid use does not exist, the contained and controlled stockpiling of biosolids is far preferable to uncontrolled dumping.

Biosolids can be applied in almost every climate and environment, although they should not be stored where there is frequent flooding or where the groundwater table is high.

**Health Aspects/Acceptance** Since the Surface Disposal site is located far from and protected from the public, there should be no risk of contact or nuisance. Care should be taken to protect the disposal site from vermin and from pooling water, both of which could exacerbate smell and vector problems.

**Maintenance** Maintenance staff should ensure that only appropriate materials are disposed of at the site, and must maintain control over the traffic and hours of operation.

**Pros & Cons:**

- + Can make use of vacant or abandoned land
- + Low cost
- + May prevent unmitigated disposal
- Non-beneficial use of a resource
- Odours are normally noticeable (depending on prior treatment)
- May require special spreading equipment
- Micropollutants may accumulate in the soil and contaminate groundwater

**References**

---

- \_ U.S. EPA (1999). *Biosolids Generation, Use, and Disposal in the United States*, EPA-530/R-99-009. U.S. Environmental Protection Agency: Washington, D.C. Available: [www.epa.gov](http://www.epa.gov)
- \_ U.S. EPA (1994). *A Plain English Guide to the EPA Part 503 Biosolids Rule*. EPA832-R-93-003. U.S. Environmental Protection Agency: Washington, D.C. Available: [www.epa.gov](http://www.epa.gov)





**Aerobic:** means ‘requiring oxygen’. Aerobic processes can only function in the presence of molecular oxygen (O<sub>2</sub>), and aerobic organisms are those that use oxygen to drive cellular respiration and store energy.

**Anaerobic:** means ‘in the absence of oxygen’. Anaerobic processes are either hindered, or halted by the presence of oxygen. Anaerobic processes are often more foul-smelling than aerobic processes.

**Anal cleansing water:** is water that is collected after having been used to clean oneself after defecating (and/or urinating). It is generated by those who use water, rather than dry material for anal cleansing.

**Anoxic:** means ‘deficient in oxygen’. Organisms that can live in an anoxic environment can use oxygen that is bound in other molecules (e.g. nitrate, sulphate). Anoxic conditions are often found at the interface between aerobic and anaerobic environments (e.g. in trickling filters or in facultative ponds).

**Bacteria:** bacteria are simple, single cell organisms. Bacteria obtain nutrients from their environments by excreting enzymes which dissolve complex molecules into more simple ones that can then pass through the cell membrane. Bacteria live everywhere on earth and are essential for maintaining life and performing essential ‘services’ such as composting, aerobic degradation of waste, and digesting food in our stomachs; some types however can be pathogenic and cause severe illness.

**BOD/Biochemical Oxygen Demand:** a measure of the amount of oxygen used by bacteria to degrade organic matter in wastewater (expressed in mg/L). It is a proxy measure for the amount of organic material that is present in water: the more the organic content, the more oxygen required to degrade it (high BOD); the lower the organic content, the less oxygen required to degrade it (low BOD).

**Biological treatment:** the use of living organisms (e.g. bacteria) to treat waste; this is in contrast to chemical treatment which relies on chemicals to transform or remove contaminants from waste.

**Biodegradable:** a substance that can be broken down into basic molecules (e.g. carbon dioxide, water) by organic processes carried out by bacteria, fungi, and other microorganisms.

**Biomass:** refers to the quantity of living organisms. It is often used to describe the ‘active’ part of the sludge that is responsible for degrading the organic matter.

**Biogas:** the common name for the mixture of gases released from anaerobic digestion. Typically biogas is comprised of methane (50–75%), carbon dioxide (25–50%) and varying quantities of nitrogen, hydrogen sulphide, water and other components.

**Biosolids:** faecal sludge that has been digested/stabilized. Biosolids can be used and applied with reduced risk compared to raw faecal sludge.

**Blackwater:** the mixture of urine, faeces and flushing water along with anal cleansing water (if anal cleansing is practiced) or dry cleansing material (e.g. toilet paper). It is high in organics and pathogens.

**Brownwater:** the mixture of faeces and flushing water, but with NO urine.

**CBO:** Community Based Organization (CBO) is a small organization that does not have the registered status of an NGO (Non-Governmental Organization) but is a structured group of volunteers who work together to achieve a common goal. Anyone can start their own CBO.

**Cesspit:** a covered hole or pit to receive drainage or sewage.

**Chemical treatment:** the treatment of wastewater using chemicals to remove pollutants from the wastewater. A common example is the use of alum for coagulation or chlorine for oxidation.

**C:N ratio:** carbon to nitrogen ratio. This ratio describes the relative amounts of dry available carbon to dry available nitrogen. The ideal value for microbes is around 30:1 (usually expressed as just 30).

**Coagulation:** the process of forming small clumps so particles so that they may be more easily settled out of wastewater.

**COD/Chemical Oxygen Demand:** Quantitative measure of the amount of oxygen required for chemical oxidation of carbonaceous (organic) material in a sample by a strong chemical oxidant, expressed in mg/L. COD is always equal to or higher than BOD since it is the sum of the oxygen required for both biological and chemical oxidation.



**Combined Sewers:** sewers that are designed to carry both blackwater and greywater from homes and stormwater (rainfall). Combined sewers must be larger than Separate Sewers to account for the high volume.

**Compost/EcoHumus:** the earth-like, brown/black material that is the result of decomposed organic matter; generally is has been hygienized sufficiently that it can be used safely in agriculture.

**Composting:** the process by which biodegradable components are biologically decomposed under controlled conditions by microorganisms (mainly bacteria and fungi).

**Concrete:** A mixture of cement, sand, gravel and water that will harden into a solid, stone-like material.

**Decentralization:** the shift of decision making and responsibility from central authorities to the same level at which the policies are directed.

**Decomposition:** the transformation of dead organic material (plants, animals, etc.) into more basic compounds and elements.

**Desludging:** the process of removing sludge from a tank, pit, or other storage unit.

**Digestion:** similar to decomposition, but usually applied to the decomposition of organic materials (including bacteria) by bacteria, in sludge.

**Dry Cleansing Materials:** may be paper, corncobs, stones or other dry materials that are used for anal cleansing (instead of water). Depending on the system, the dry cleansing materials may be collected and disposed of separately.

**E. Coli:** the common abbreviation of *Escherichia Coli*. It is a type of bacteria that inhabits the intestinal tract of humans, and other mammals. It is not necessarily harmful, but it is used to indicate the presence of other, more dangerous bacteria.

**Ecological Sanitation:** is a term applied to waste treatment technologies when they not only limit the spread of disease, but protect the environment and return nutrients to the soil in a beneficial way.

**Effluent:** the general name for a liquid that leaves the place or process from where it originated.

**Environmental Sanitation:** as opposed to simply 'sanitation', seeks to include all aspects of the physical environment which may affect human health and well-being; typical examples of an environmental sanitation program may include potable water, solid waste management, drainage, stormwater management, and sanitation.

**Eutrophication:** describes excess nutrient concentrations in an aquatic ecosystem which leads to: (i) increased productivity of autotrophic green plants and to the blocking out of sunlight, (ii) elevated temperatures within the aquatic system, (iii) depletion of oxygen, (iv) increased algae growth, and (v) reduction in fauna and flora variety.

**Evaporation:** the process of water changing from a liquid state to a gaseous state.

**Evapotranspiration:** evaporation that is facilitated by vegetation. Plants emit water through their stoma (pores) thus providing a greater surface from which water can evaporate.

**Excreta:** the mixture of urine and faeces that is not mixed with any flushing water.

**Faecal Sludge:** the general term for the undigested or partially digested slurry or solid that results from the storage or treatment of blackwater or excreta.

**Faeces:** refers to (semi-solid) excrement without any urine or water.

**Filtrate:** the liquid that has passed through a filter.

**Floatation:** The processes whereby lighter fractions of a wastewater, including fats, oils, soaps, etc., rise above the water and the solids, and can thus be separated.

**Flushwater:** the water that is used to transport excreta, urine and/or faeces from the User Interface to the next Functional Group technology.

**Forage:** aquatic or other plants that grow in planted drying beds or constructed wetlands and may be harvested for feeding livestock.

**Greywater:** the total volume of water generated from the washing of food, clothes, dishware and people. It does not contain excreta, but it does contain pathogens and organics.

**Groundwater:** water that is naturally present beneath the surface of the ground. In some instances groundwater may be found several centimetres below the surface, or it may be up to a hundred metres below the surface. Groundwater is generally quite clean and can be used for drinking water; for this reason care must be taken not to contaminate groundwater with sewage.

**HCES:** Household-Centred Environmental Sanitation is a 10-step participatory planning process. The goal of the HCES approach is to involve stakeholders to develop an Urban Environmental Sanitation Services Plan which will allow people to lead healthy and productive lives, protect the natural environment while conserving and reusing resources. The guidelines for implementing HCES are available from [www.sandec.ch](http://www.sandec.ch).

**Health:** “is a state of complete physical, mental and social well-being and not merely the absence of disease or infirmity.” (WHO, 1948).

**Helminth:** A parasitic worm, i.e. one that lives in or on its host, causing it damage. Examples include especially parasitic worms of the human digestive system, such as roundworm (e.g. *Ascaris*) or hookworm.

**Humus:** an earth-like dark brown or black material comprised primarily of decomposed organic material.

**Hydraulic Retention Time (HRT):** defines the (average) amount of time that a liquid stays in a reactor. It has the unit of time (t) and is calculated by dividing the volume of the reactor ( $m^3$ ) by the flow ( $m^3/h$ ).

**Hydraulic Gradient:** the surface slope of a liquid in a pipe, i.e. the liquid will flow along the hydraulic gradient of the system and if there is an inflow that is lower than the gradient, water will flow upwards to meet the gradient line.

**Influent:** the general name for the liquid that enters into a place or process; the effluent of one process is the influent of the next.

**Invert:** the bottom of the inside of a pipe. The depth of the invert is especially important when designing sewers.

**Leachate:** the liquid fraction of a mixed waste that, through gravity or filtration, is separated from the solid component.

**Lime:** the common name for calcium hydroxide. It is a white, caustic powder that is produced by heating limestone.

**Macrophytes:** large aquatic plants visible to the naked eye. Their roots and differentiated tissues may be emergent (cattails, bulrushes, reeds, wild rice), submergent (water milfoil, bladderwort) or floating (duckweed, lily pads).

**Microbe:** general name given to a microorganism; a microscopic bacterium.

**Microorganisms:** neither plant nor animal, but small, simple unicellular or multicellular organisms such as protozoa, algae, fungi, viruses, and bacteria.

**Micropollutants:** pollutants which are present in extremely low concentrations, but whose effect is known to be significant. Pharmaceuticals and hormones are two groups of micropollutants which are causing increasing concern for their effects on the endocrine system and sexual development.

**Monitoring:** the continuous collection and assessment of data (qualitative and quantitative) with the intended goal of optimizing performance and minimizing flaws.

**Nightsoil:** the name generally given to excrement that may be collected manually. Generally this practice is carried out where there is neither infrastructure for collection and storage or where there is agricultural land that can receive the waste. Unprotected handling and use in agriculture should be treated with caution.

**Nutrient:** any substance (including protein, fat, carbohydrate, vitamins, or minerals) that is used for growth. In wastewater treatment systems, ‘nutrient’ usually refers to nitrogen and/or phosphorus since they are primarily responsible for eutrophication.

**Oocyst:** a thick-walled spore into which different organisms (like *Cryptosporidium*) can transform as a way of resisting, and surviving through periods of environmentally harsh conditions.

**Operation and Maintenance:** all work relating to the day-to-day activities that keep a process or system functioning smoothly to prevent delays, repairs and/or downtime.

**Organics:** general name given to organic materials. An organic is any molecule that contains carbon. Examples of organic compounds are proteins, lipids, amino acids, vitamins, and other building blocks of life. Organics refers to the organic material that must be added to some technologies in order to make them function properly (e.g. composting chambers).

**Pathogen:** infectious biological agent (bacteria, protozoa, fungi, parasites, viruses) that inflicts disease or illness on its host.

**Parasite:** any organism that lives on or in another organism and damages its host.

**Percolation:** the movement of liquid through soil with the force of gravity.

**PET:** PET is the common name for Polyethylene terephthalate. It is a clear plastic that can be recycled.

**pH:** the measure of the acidity or alkalinity of a substance. A pH value below 7 indicates that it is acidic, a pH value above 7 indicates that it is basic (alkaline).

**Retention time:** the theoretic time that one unit of water (or sludge) stays in one tank or pond. When referring to units of water, the term Hydraulic Retention Time is often used (HRT) and is calculated by:  $HRT = V/Q$ , where V is the volume of the tank and Q is the rate at which the water leaves (e.g.  $m^3/h$ ).

**Runoff:** also referred to as Surface Runoff. It is the quantity of water that falls as precipitation but does not infiltrate to the groundwater table.

**Sanitation:** general term used to describe a battery of actions that all aim to reduce the spread of pathogens and maintain a healthy living environment. Specific actions related to sanitation include, wastewater treatment, solid waste management and stormwater management.

**Scum:** general name given to the top, floating layer of material that sits above the water. It is most noticeable in septic tanks where distinct layers of scum, water, and sludge form over time.

**Sedimentation:** gravity settling of particles in a liquid such that they accumulate. Also called settling.

**Septage:** 'liquid and solid material pumped from a septic tank, cesspool or other primary treatment source'. (Bellagio, 2005).

**Sewage:** general name given to the mixture of water and excreta (urine and faeces), although in the Compendium it referred to as blackwater.

**Sewer:** an open channel or closed pipe used to convey sewage.

**Sewerage:** all the components of a system used for collecting, transporting and treating sewage (including pipes, pumps, tanks, etc.).

**Sitter:** the general name given to someone who prefers to sit on the User Interface, rather than squat over it.

**Sludge:** the thick, viscous layer of materials that settles to the bottom of septic tanks, ponds, and other sewage systems. Sludge is comprised mostly of organics, but also sand, grit, metals, and various chemical compounds.

**Specific Surface Area (SSA):** describes the property of a solid material. SSA is defined as the ratio of the surface area to the volume in units of  $m^2/m^3$ .

**Squatter:** the general name given to someone who prefers to squat over the User Interface, rather than sit directly on it.

**Stabilized:** the term used to describe the state of organic material that has been completely oxidized and sterilized. When most of the organic matter has been degraded, bacteria begin to starve and consume their own cytoplasm. The organic matter left by the dead bacteria is then degraded by other organisms, which results in a fully stabilized product.

**Stakeholder:** any group, person, or agency that has an interest in or is affected by a policy, plan, or project.

**Stormwater:** the general term for the rainfall that runs off of roofs, roads and other surfaces before flowing towards low-lying land. It is the portion of rainfall that does not infiltrate into the soil.

**Sullage:** synonym for greywater. It includes wastewater from cooking, washing, and bathing, but does not include any excreta.

**Superstructure:** name given to the structure that provides privacy to a person using a toilet/bathing facility. A superstructure may be permanent (made of concrete or bricks) or mobile (made of bamboo or cloth).

**Surface water:** term to describe rainwater that runs overland (i.e. does not infiltrate the ground). Surface water, unlike ground water is generally not safe for consumption as it accumulates pathogens, metals, nutrients and chemicals as it flows across contaminated surfaces.

**Sustainability:** “meets the needs of the present generation without compromising the ability of future generations to meet their own needs” (Brundtland Commission, 1987).

**Sustainable Sanitation:** “The main objective of a sanitation system is to protect and promote human health by providing a clean environment and breaking the cycle of disease. In order to be sustainable a sanitation system has to be not only economically viable, socially acceptable, and technically and institutionally appropriate, it should also protect the environment and the natural resources” (SuSanA, 2007).

**TS:** Total Solids (TS) is the sum of Total Dissolved Solids (TDS) and Total Suspended Solids (TSS). When a water or sludge sample is filtered and dried at 105°C, the residue that remains is referred to as the Total Solids. It is measured in mg/L (mass per volume).

**Urea:** the organic molecule  $(\text{NH}_2)_2\text{CO}$  that is excreted in urine as a way of ridding the body of excess nitrogen. With time, the urea in urine breaks down into carbon dioxide and ammonia, which is readily used by organisms in soil.

**Urine:** is the liquid waste produced by the body to rid itself of urea and other waste products.

**Vector:** the organism that transmits a disease to the host (the vector itself may be a host, but is not the ‘true host’). Flies are vectors as they can transmit pathogens from faeces to humans.

**Ventilation:** the movement of air; air is both supplied to, and removed from a space.

**WC:** derived from the words ‘Water Closet’. It is an ambiguous term that can either refer to the actual room where a toilet is located, or the actual toilet itself.

**Washer:** the general name for those who use water to cleanse after defecating.

**Wastewater:** traditionally described as any water that has been used and is unfit for further use. The term is applied broadly to all waters originating in toilets, showers, sinks, washing areas, factories, etc. More recently terms such as ‘blackwater’, ‘greywater’ and ‘yellow water’ have been adopted both as a way to describe the composition more accurately, and to emphasize the fact that used waters have nutrients, are valuable, and should not be ‘wasted’.

**Water table:** the top level of the groundwater; also referred to as the groundwater table. A water table is not static and can vary with season, year, and usage.

**Wiper:** the general name for those who use solid materials, like paper, to cleanse after defecating.

**Yellowwater:** is the name for urine combined with flushing water. It is not included in any of the systems in this Compendium.

Bibliographic reference:

Tilley, Elizabeth et al, 2008. Compendium of Sanitation Systems and Technologies. Swiss Federal Institute of Aquatic Science and Technology (Eawag). Dübendorf, Switzerland.

ISBN: 978-3-906484-44-0

© Eawag/Sandec; Swiss Federal Institute of Aquatic Science and Technology / Water and Sanitation in Developing Countries, Dübendorf, Switzerland, [www.sandec.ch](http://www.sandec.ch)

© WSSCC; Water Supply and Sanitation Collaborative Council, Geneva, Switzerland, [www.wsscc.org](http://www.wsscc.org)

Permission is granted for reproduction of this material, in whole or part, for education, scientific or development related purposes except those involving commercial sale, provided that full citation of the source is given.

Graphic Design: Pia Thür, Zürich

Technical Drawings: Paolo Monaco, Zürich

Photos: Eawag-Sandec

First edition: 2000 copies

Printed by: Mattenbach AG, Winterthur, Switzerland

Eawag  
Überlandstrasse 133  
P.O. Box 611  
8600 Dübendorf  
Switzerland  
Phone +41 (0)44 823 52 86  
Fax +41 (0)44 823 53 99  
info@sandec.ch  
www.eawag.ch  
www.sandec.ch

Water Supply & Sanitation  
Collaborative Council  
  
International Environment House  
Chemin des Anémones 9  
1219 Châtelaine-Geneva  
Switzerland  
Phone +41 22 917 8657  
wsscc@who.int  
www.wsscc.org

**Abundant information exists about sanitation solutions but it is scattered throughout hundreds of books and journals; this Compendium aims to pull it all together in one volume. By ordering and structuring a huge range of information on tried and tested technologies into one concise document, the reader is provided with a useful planning tool for making more informed decisions.**

**Part 1 describes different system configurations for a variety of contexts.**

**Part 2 consists of 52 different Technology Information Sheets, which describe the main advantages, disadvantages, applications and the appropriateness of the technologies required to build a comprehensive sanitation system. Each Technology Information Sheet is complemented by a descriptive illustration.**